

# Assembly Instructions

## Armchair

CAUTION : You must read this before you proceed.

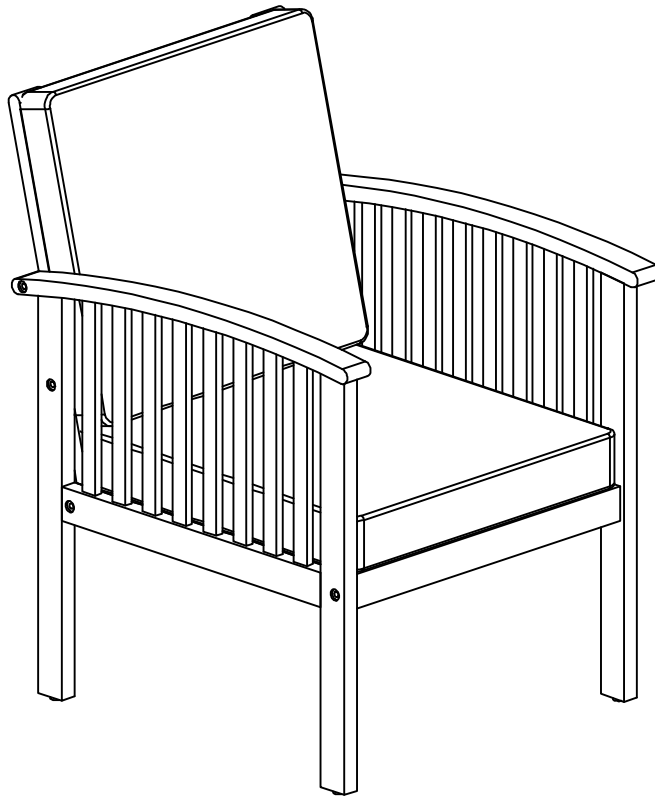

CAUTION: This is NOT a TOY assembly.  
Keep your child / children at bay in the process of assembly.

# Assembly Preparation

Before Beginning Assembly:

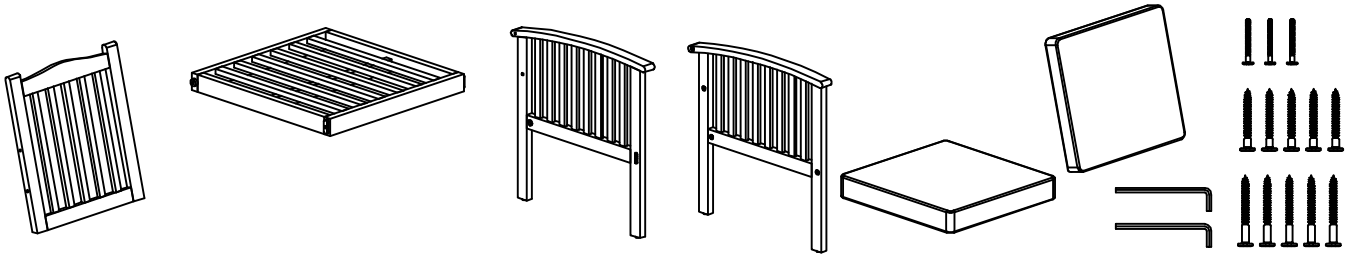

• Read instruction, cover to cover-



• Have 2 adults on hand for assembly-



• Do not assembly on flooring or carpet-





• Assemble on a clean non- marring surface (packing foam)-





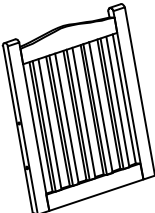
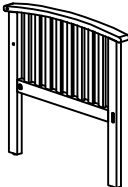
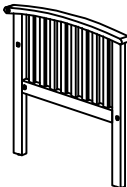

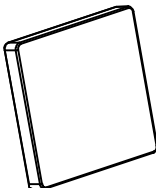
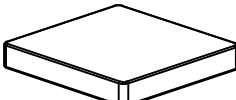
• Save all packaging until finished-

## Parts List

No.	Picture	Description	Qty
A		Backrest Panel	1
B1		Right Arm with Leg Panel	1
B2		Left Arm with Leg Panel	1
C		Seat Panel	1
D		Back Cushion	1
E		Seat Cushion	1

# Hardware

No.	Picture	Description	Qty
①		Screw (M7*70mm)	5
②		Screw (M7*60mm)	5
③		Bolt (M6*70mm)	3
④		Allen Wrench	2

# Assembly Steps

## OVER VIEW

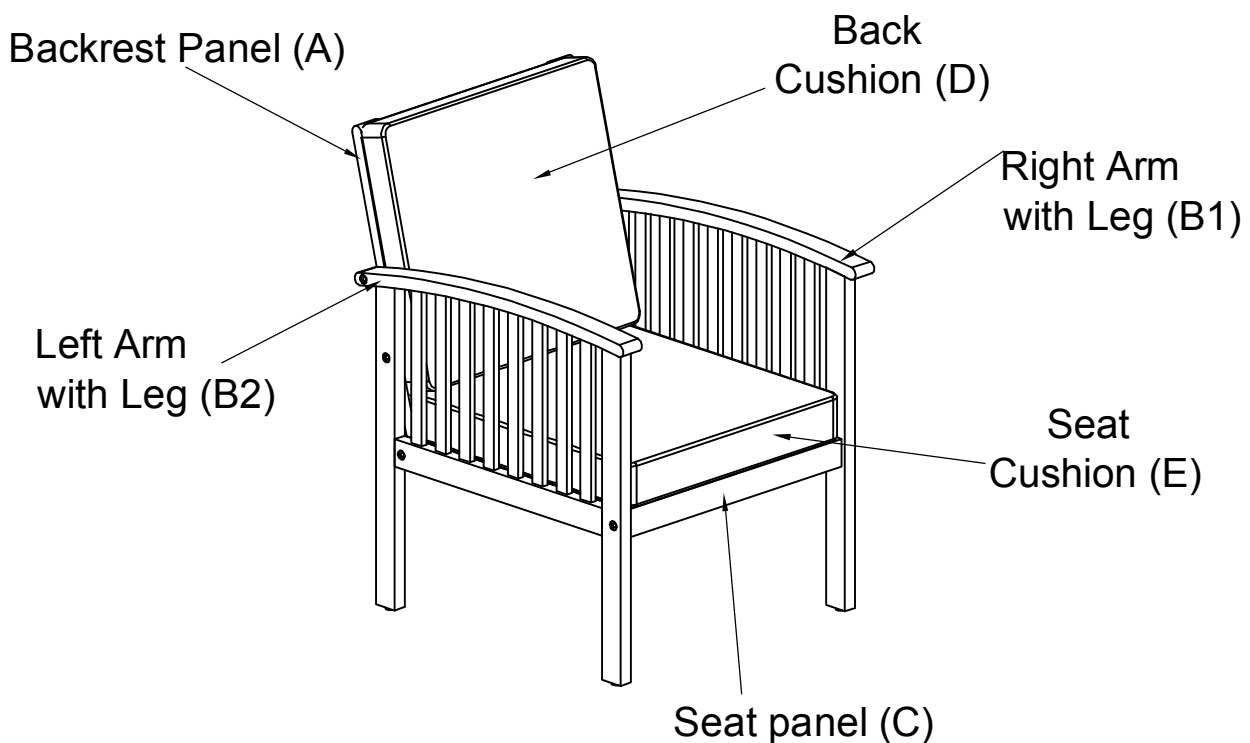

**FRONT VIEW**

This Chair has multiple parts and may require up to some 30 minutes to assemble. To give you an overview of the Chair, the above picture is to help you put the various parts into perspective. Please read through the instructions here below to familiarise the parts and steps before assembly.

## Step 1

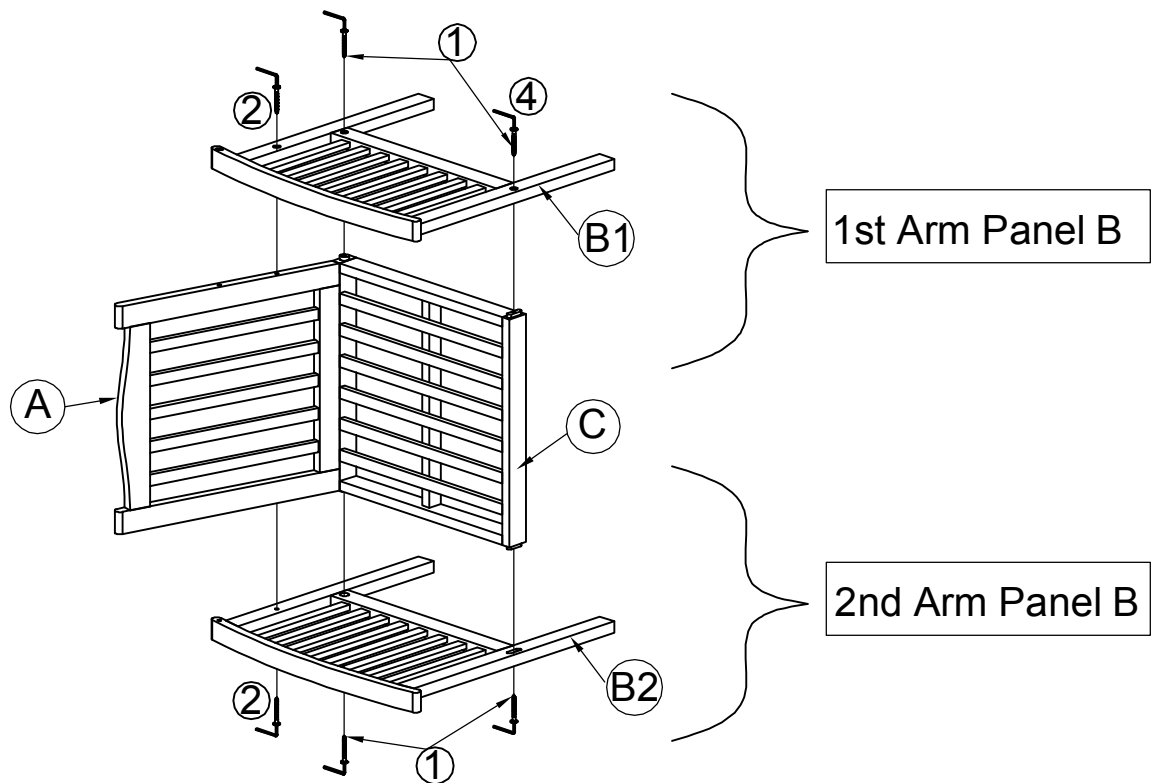

The best place to assemble this Armchair is on a flat surface, eg., floor.  
Position Parts Backrest (A) and Seat Panel (C) as shown in picture above.

Affix 1st Right Arm Panel (B1) ( facing skywards ), as shown above.

Attach Arm Panel(B1) and Backrest Panel(A) by using 1 Screw ( ②)+Allen Wrench(④)

Attach Arm Panel(B1) and Seat Panel(C) by using 2 Screws ( ②)+Allen Wrench(④)

Then, flip chair to rest on 1st Arm(B1) so that 2nd Arm (B2) is now facing skywards.  
Repeat the same process by affixing Screws to designated points.

**CAUTION: DO NOT TIGHTEN SCREWS**

## Step 2

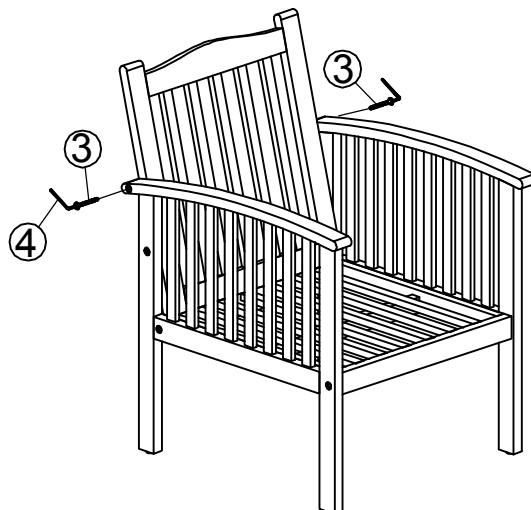

Use Bolt (③)with Allen Wrench ( ④) to affix the top of the Backrest to the  
Armrests on both sides as shown.

**DO NOT TIGHTEN BOLTS**

### Step 3

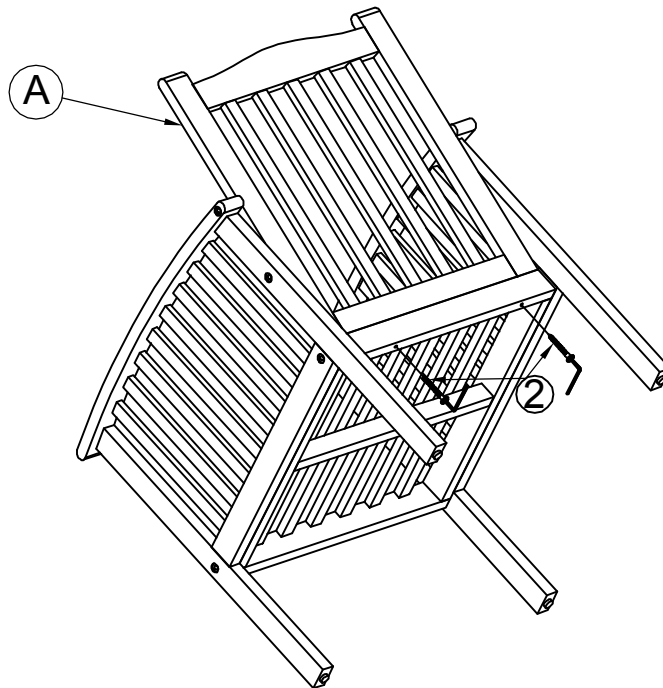

BACK VIEW OF CHAIR

Use Screw (②) and Allen Wrench (④) to attach Backrest Panel(A) and Seat Panel(C). **DO NOT TIGHTEN SCREWS**

### Step 4

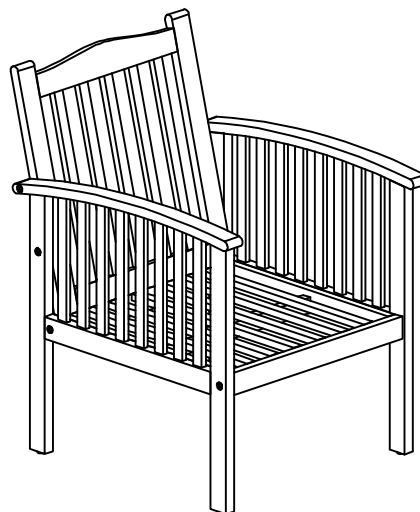





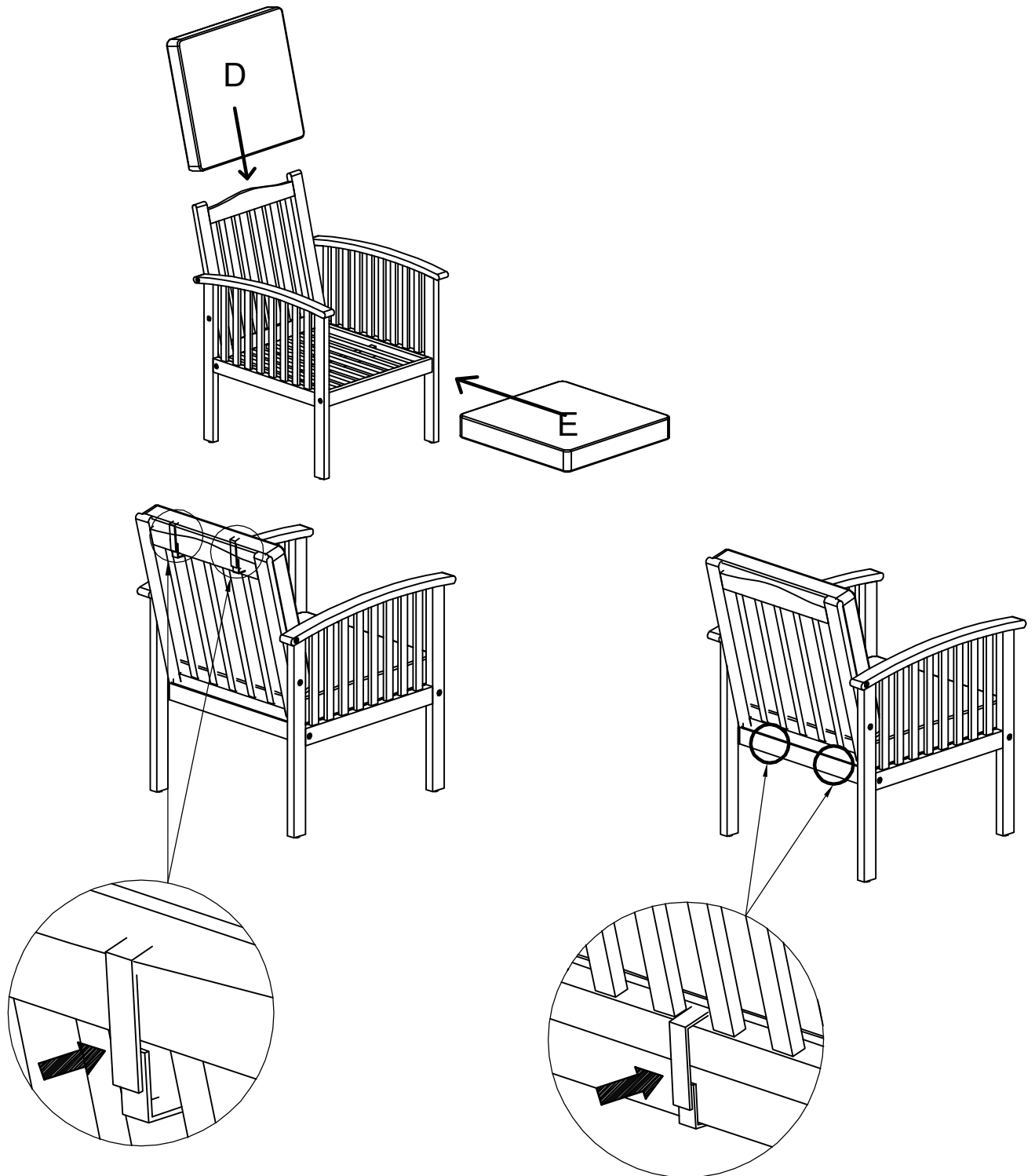



Turn the Chair right side up.  
Inspect it and make sure all parts are adequately connected.  
Ensure all bolts and screws are fully locked into position and secured.

## Step 5



Place Seat Cushion(E) and Back Cushions(D) onto the Chair.  
Tie the magic tape straps of Seat Cushion(E) and Back Cushions(D) to Seat Panel(C) and Backrest Panel(A) as pictured.  
The Chair is ready to be used.  
**This Chair can only be used on a flat, level surface.**

## Care & Maintenance

- ⊘  ● Do not put hot items directly on furniture surface
  - ⊘  ● Do not clean furniture with harsh cleansers or polish.
  - ✓  ● To obtain the longest lifespan of your outdoor products, minimizing exposure to direct sunlight is recommended.
  - ⊘  ● Children should not climb or jump on the furniture.
  - ⊘  ● Do not write on furniture without a padded barrier to protect the surface.
  - ✓  ● To obtain the longest lifespan of your outdoor products, avoid extended and lengthy exposure to rain, snow, and direct sunshine. Whenever possible cover the product and / or place under patio or awnings.
  - ⊘  ● Not for commercial use. For residential use only .
  - ⊘  ● Stains may be removed with mild soap solution and damp cloth.
  - ✓  ● Dust and pick-up spills using a clean, non colored lint-free cloth
-