





















# Assembly Instructions

Caution : You must read this before you proceed

## Care & Maintenance

-   ● Not for commercial use. For residential use only .
-   ● Do not put hot items directly on furniture surface
-   ● Do not clean furniture with harsh cleansers or polish.
-   ● To obtain the longest lifespan of your outdoor products, minimizing exposure to direct sunlight is recommended.
-   ● Children should not climb or jump on the furniture.
-   ● Do not write on furniture without a padded barrier to protect the surface.
-   ● To obtain the longest lifespan of your outdoor products, avoid extended and lengthy exposure to rain, snow, and direct sunshine. Whenever possible cover the product and /or place under patio or awnings.
-   ● Stains may be removed with mild soap solution and damp cloth.
-   ● Keep away from sources of ignition.
-   ● Dust and pick-up spills using a clean, non-colored, lint-free cloth .

Please look in the Seat Panel for hardware packs.

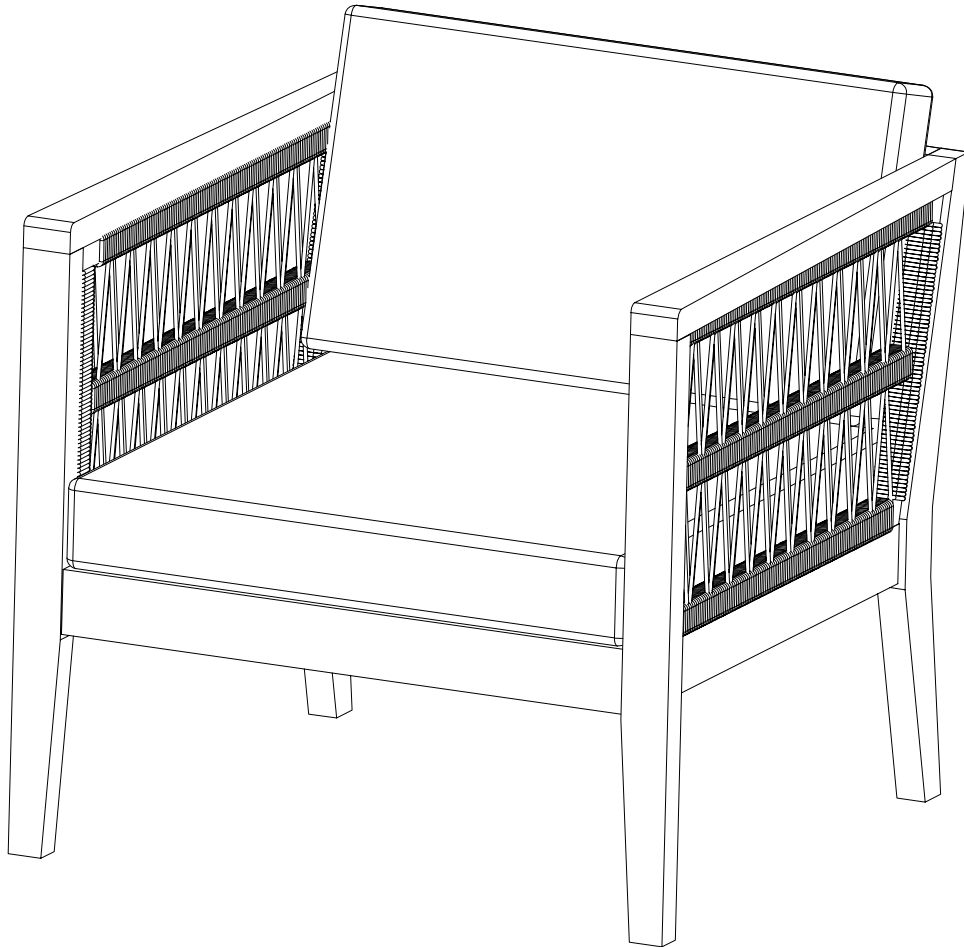

# Club Chair - N780P171148F

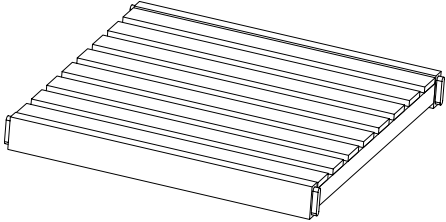
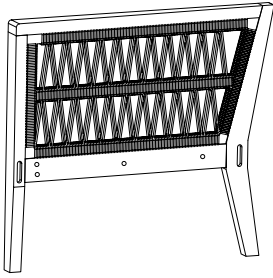
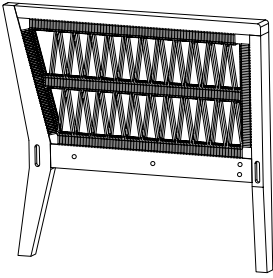
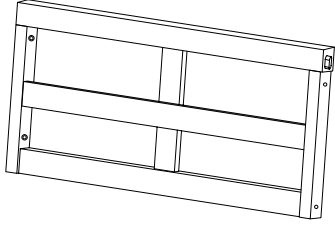
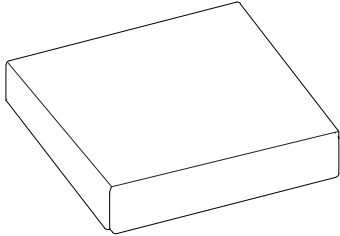
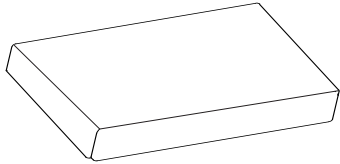

# Parts List

Label	Picture	Description	QTY
A	 A perspective view of a rectangular seat panel with a series of parallel slats.	Seat Panel	1
B	 A perspective view of a chair leg panel, showing a wooden frame with a mesh backrest and a seat panel.	Left Leg Panel	1
C	 A perspective view of a chair leg panel, showing a wooden frame with a mesh backrest and a seat panel.	Right Leg Panel	1
D	 A perspective view of a rectangular backrest panel with a wooden frame and a mesh backrest.	Backrest	1
E	 A perspective view of a rectangular seat cushion.	Seat Cushion	1
F	 A perspective view of a rectangular back cushion.	Back Cushion	1

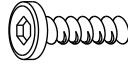
# Hardware:

No.	Picture	Description	QTY
①		Bolt (M6x35mm)	13
②		Allen Wrench	1

## Assembly Preparation

Before Beginning Assembly:

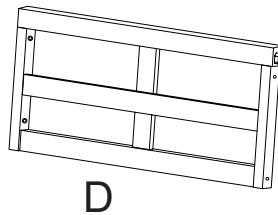
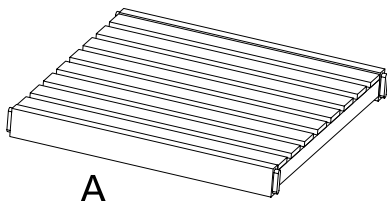

①  x 13

②  x 1

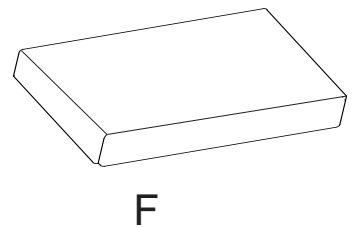
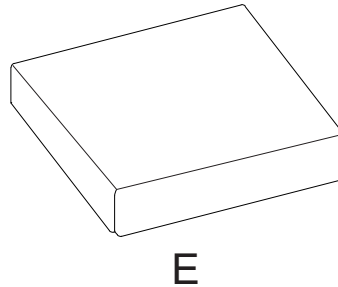
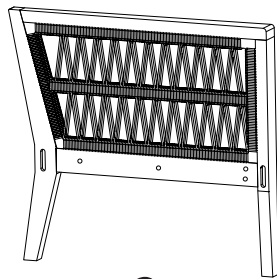
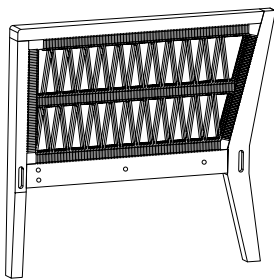

- Read instructions, cover to cover-



- Have 2 adults on hand for assembly-



- Do not assemble on flooring or carpet-



- Assemble on a clean non-marring surface (packing foam)-



- Save all packaging until finished-

# Assembly Steps

## **OVERVIEW**

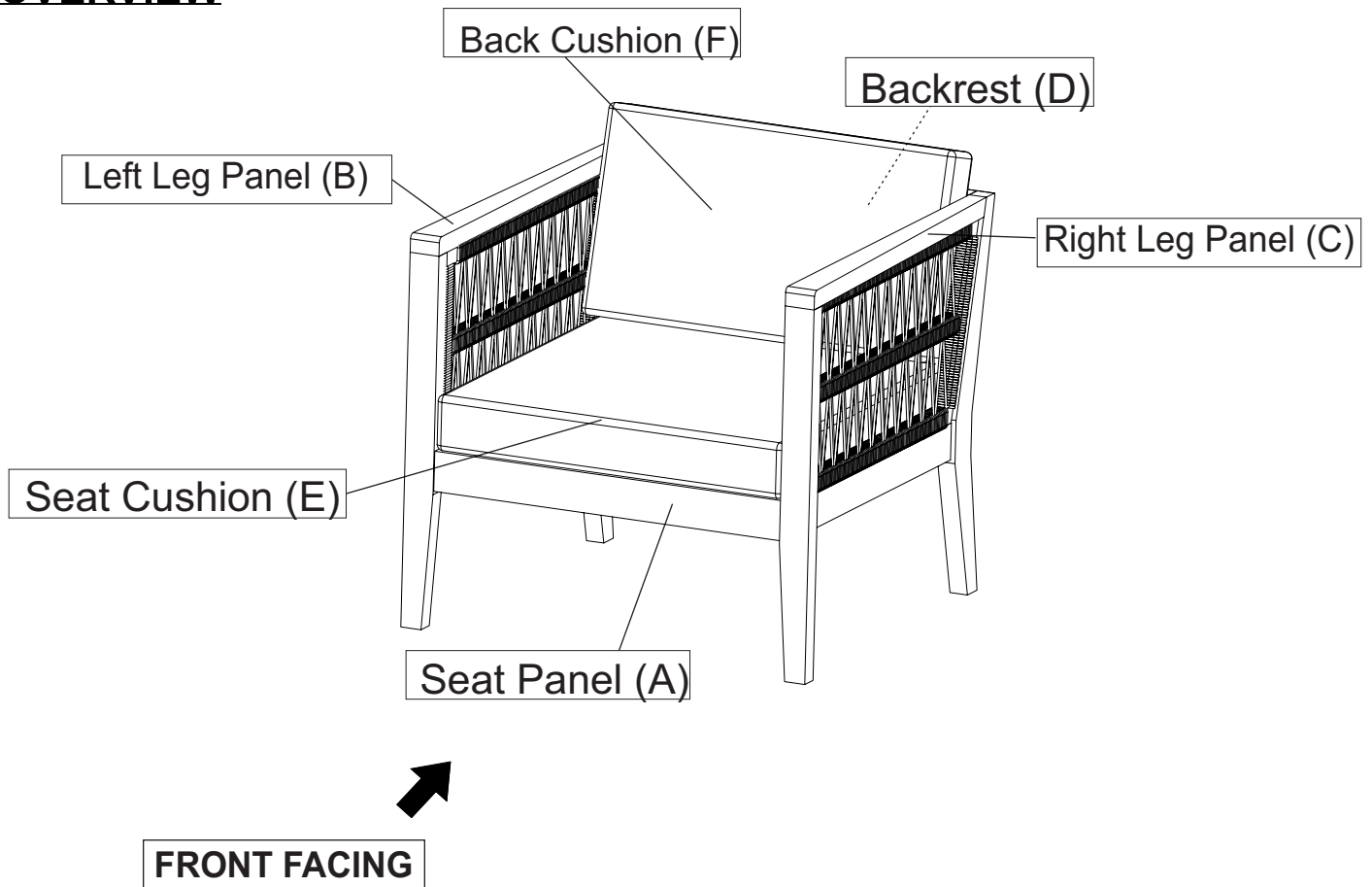

This Chair has multiple parts and may require up to 30 minutes to assemble. To give you an overview of the Chair parts, the above picture is to help you put the various parts into perspective. Please read through the instructions below to familiarise yourself with the parts and steps before assembly.

## **Step 1**

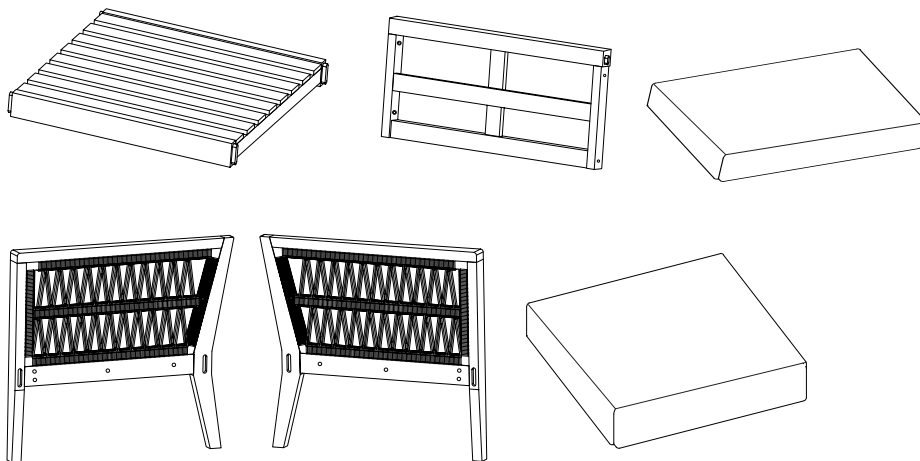

Unpack and place all parts on a clean, non-marring surface.

## **Step 2**

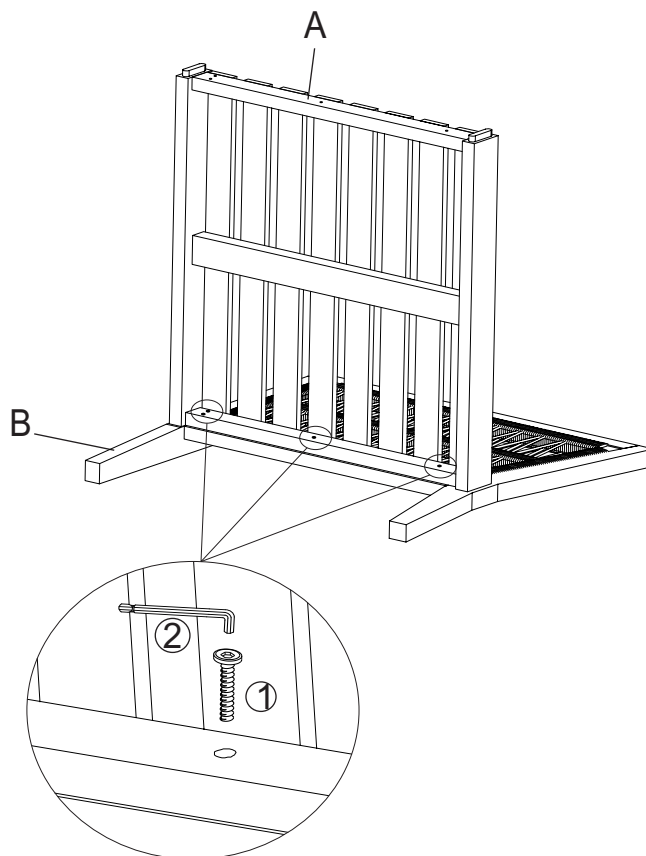

With the help of your adult partner, place the Left Leg Panel (B) and Seat Panel (A) on the surface as shown above.

Attach the Seat Panel (A) to the Left Leg Panel (B) using Bolts (①) with Allen Wrench (②) as shown in the picture above.

**Do not fully tighten the Bolts.**

## **Step 3**

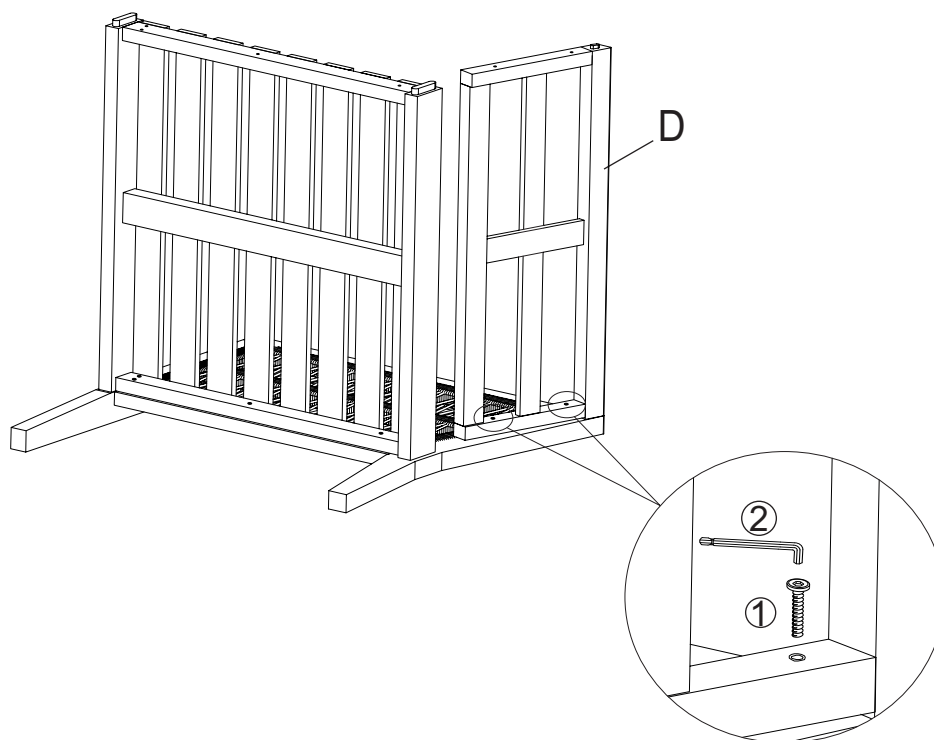

With the help of your adult partner, attach the Backrest (D) to the Left Leg Panel (B) using Screws (①) with Allen Wrench (②) as shown in the picture above.

**Do not fully tighten the Bolts.**

## **Step 4**

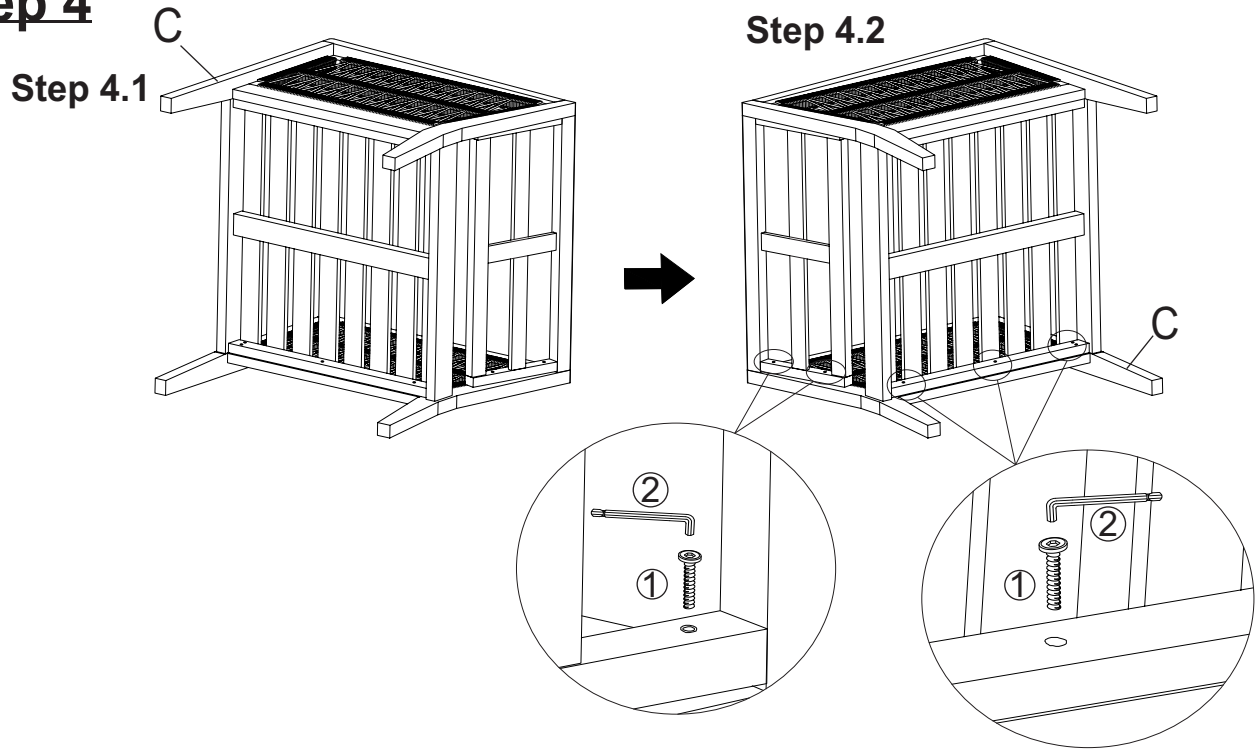

**Step 4.1:** With the help of your adult partner, attach the Right Leg Panel (C) to the Seat Panel (A) and Backrest (D) as shown above.

**Step 4.2:** Flip the product to the opposite side, then secure the Right Leg Panel (C) to the Seat Panel (A) and Backrest (D) using Screws (1) with Allen Wrench (2) as shown in the picture above.

**Do not fully tighten the Bolts.**

## **Step 5**

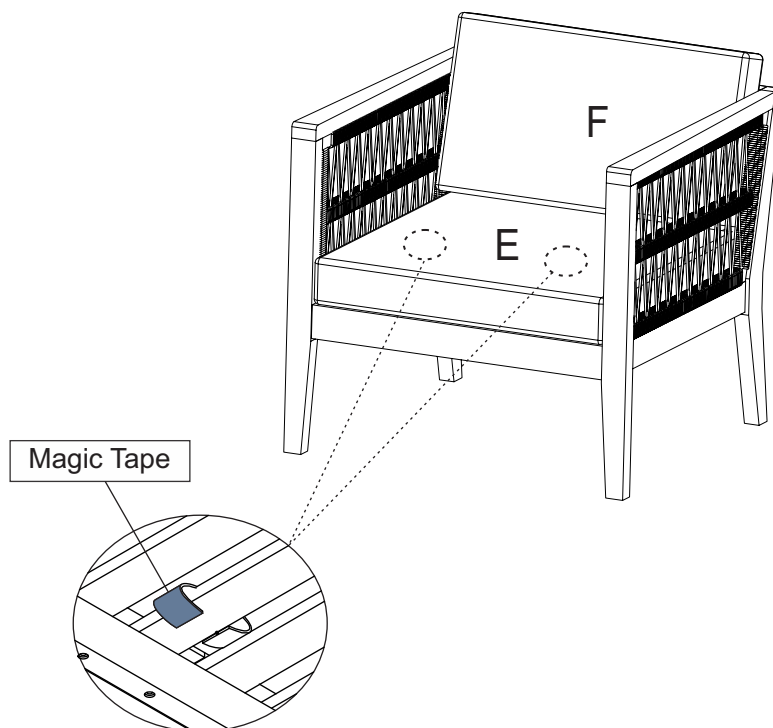

With the help of your adult partner,, stand the Chair up.

Place Seat Cushion (E) on to Seat Panel (A). Stick the magic tape of Seat Cushion (E) to Seat Panel (A). Place Back Cushion (F) on to Backrest Panel (D) as show in above picture.

## **Step 7**

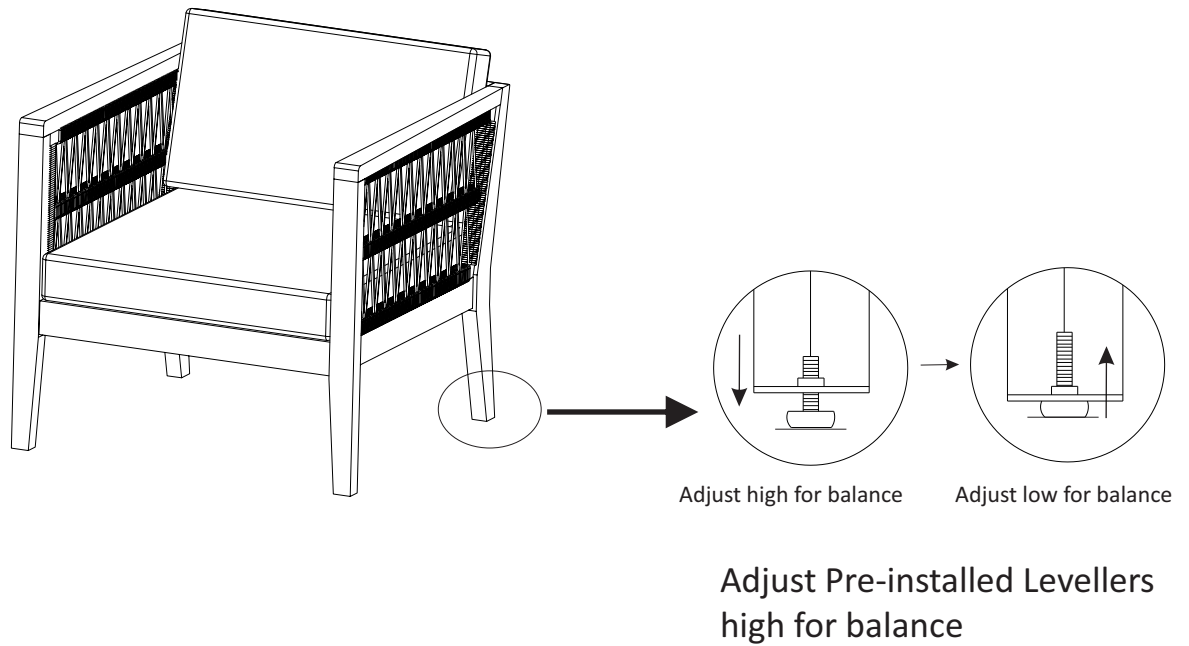

**Inspect it and make sure all parts are adequately connected.**

**Turn right side up the Chair.**

**Gently and gracefully, sit onto the Chair.**

**This will help to align all the parts at all joint areas.**

**The get off the Chair and proceed to tighten the Bolts in a sequential manner.**

**When tightening the Bolts tighten sequentially.**

**DO NOT tighten any Bolts fully and then move on towards the next one.**

**If there are still wobbles, loosen the Bolts and execute this same process.**

**Your Chair is ready for use.**

**This Chair can only be used on a flat, level surface.**