











Assembly Instructions

Caution : You must read this before you proceed

Care & Maintenance

-  ● Not for commercial use. For residential use only.
-  ● Furniture may scratch floors. We recommend using furniture pads to protect your floors.
-  ● Do not put hot items directly on furniture surface.
-  ● Do not clean furniture with harsh cleansers or polish.
-  ● Do not place furniture under direct sunlight.
-  ● Do not place furniture near heating or cooling vents.
-  ● Do not write on furniture without a padded barrier to protect the surface.
-  ● Do not place furniture outside . For indoor use only.
-  ● Stains may be removed with mild soap solution and damp cloth.
-  ● Children should not climb or jump on the furniture.
-  ● Dust and pick-up spills using a clean, non-colored, lint-free cloth.

Please look in Chair for hardware packs and legs.

Sets often ship in multiple boxes and may arrive a day or two apart.



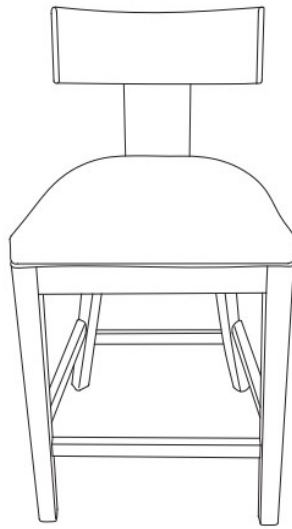

Stool



Parts List

| Label | Picture | Description | QTY |
|-------|---|-----------------|-----|
| A | A line drawing showing the seat and backrest assembly. The seat is curved and the backrest is rectangular, connected by two vertical posts. | Seat with Back | 1 |
| B | A line drawing of a single leg, angled outwards from the front. | Left Front Leg | 1 |
| C | A line drawing of a single leg, angled outwards from the front. | Right Front Leg | 1 |
| D | A line drawing of a single leg, angled outwards from the back. | Left Back Leg | 1 |
| E | A line drawing of a single leg, angled outwards from the back. | Right Back Leg | 1 |
| F | A line drawing of a horizontal bar connecting the front legs. | Front Stretcher | 1 |
| G | A line drawing of a horizontal bar connecting the back legs. | Back Stretcher | 1 |
| H | A line drawing of a horizontal bar connecting the left front and back legs. | Left Stretcher | 1 |
| I | A line drawing of a horizontal bar connecting the right front and back legs. | Right Stretcher | 1 |

Hardware

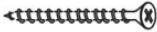
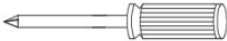
| Label | Picture | Description | QTY |
|-------|---|-----------------|-----|
| ① |  | Bolt (M8*60MM) | 5 |
| ② |  | Bolt (M8*70MM) | 5 |
| ③ |  | Spring Washer | 10 |
| ④ |  | Washer | 10 |
| ⑤ |  | Allen Wrench | 1 |
| ⑥ |  | Screw (M4x45mm) | 9 |
| ⑦ |  | Screw driver | 1 |

Assembly Preparation

Before Beginning Assembly:

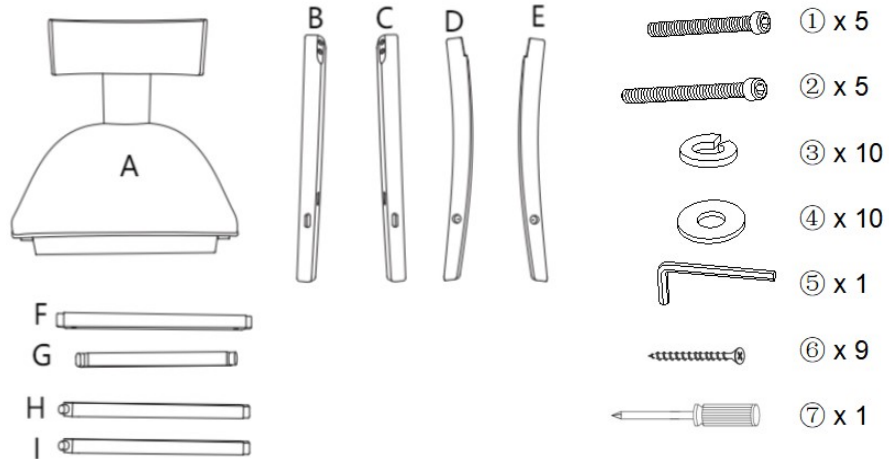

- Read instructions, cover to cover-



- Have 2 adults on hand for assembly-



- Do not assemble on flooring or carpet-



- Assemble on a clean non-marring surface (packing foam)-



- Save all packaging until finished-

Assembly Steps

Overview

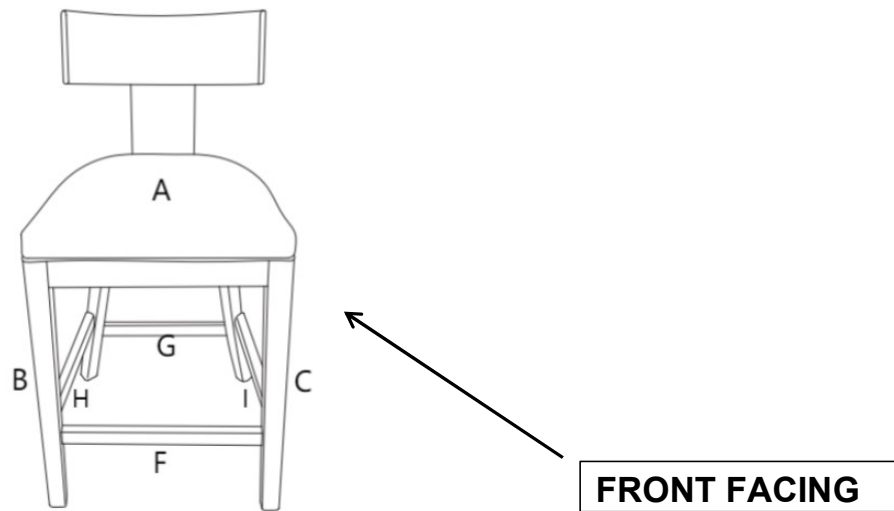

This Chair has multiple parts and may require up to 30 minutes to assemble. To give you an overview of the Chair parts, the above picture is to help you put the various parts into perspective. Please read through the instructions below to familiarise yourself with the parts and steps before assembly.

Step 1

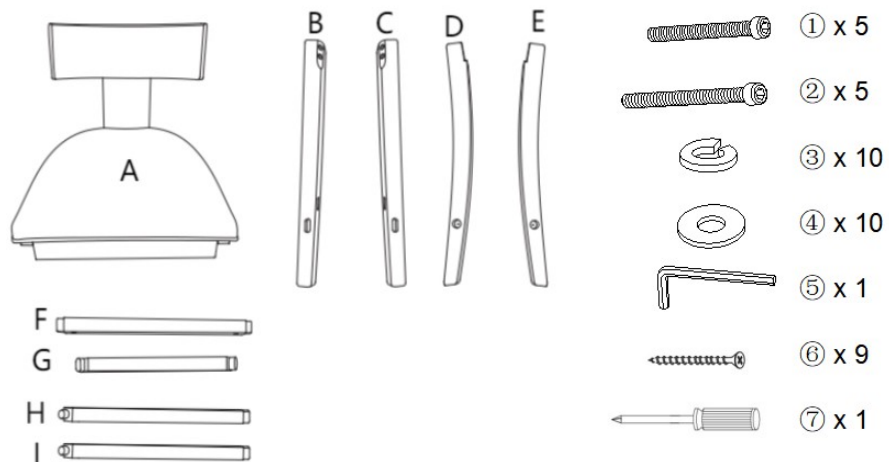

Unpack and place all parts on a clean, non-marring surface.

Step 2

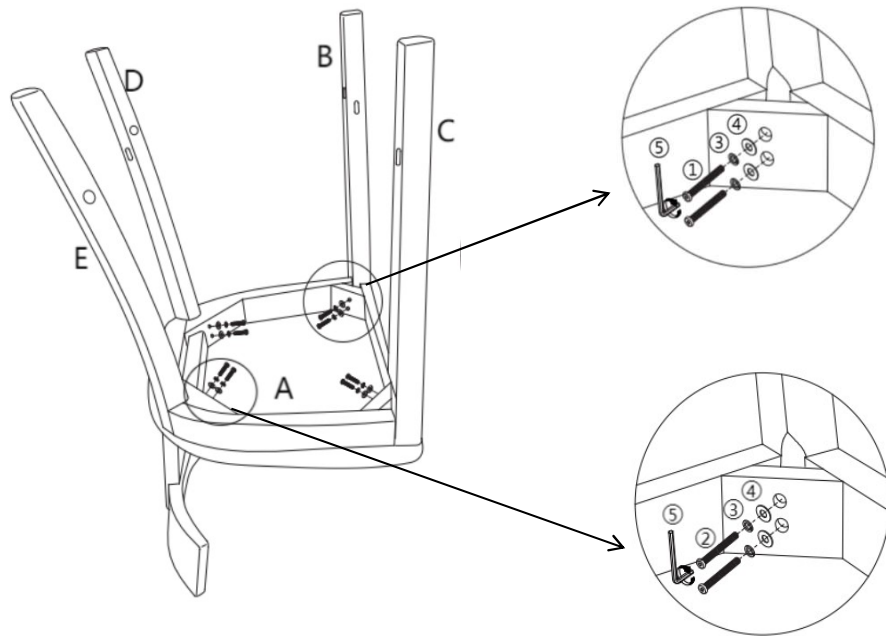

Place the Seat with Back(A) downward on a clean, non-marring table.
Attach the Left Front Leg(B) and Right Front Leg(C) to the Seat with Back(A) using Bolts(①), Spring Washers(③) and Washers(④) with the Allen Wrench(⑤).
Attach the Left Back Leg(D) and Right Back Leg(E) to the Seat with Back(A) using Bolts(②), Spring Washers(③) and Washers(④) with the Allen Wrench(⑤).
Do not fully tighten the bolts.

Step 3

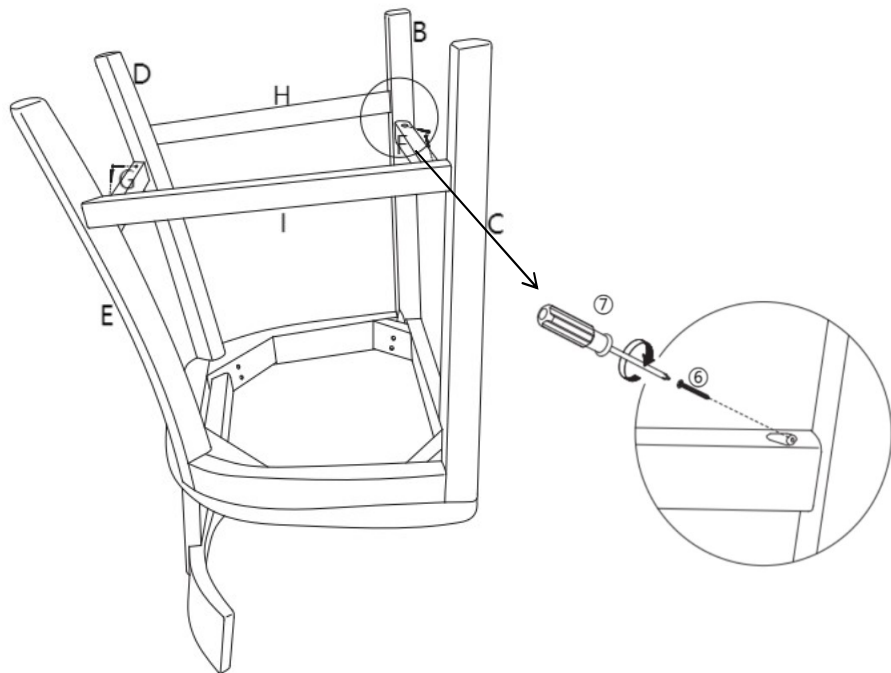

Attach the Front Stretcher(F) into the mounting position of Left Front Leg(B) and Right Front Leg(C)using Screws(⑥) with the Screw driver(⑦).

Attach the Back Stretcher(G) into the mounting position of Left Back Leg(D) and Right Back Leg(E)using Screws(⑥) with the Screw driver(⑦).

Attach the Left Stretcher(H) into the mounting position of left Front Leg(B)and Left Back Leg(D)using Screws(⑥) with the Screw driver(⑦).

Attach the Right Stretcher(I) into the mounting position of Right Front Leg(C)and Right Back Leg(E) using Screws(⑥) with the Screw driver(⑦).

Do not fully tighten the screws.

Step 4

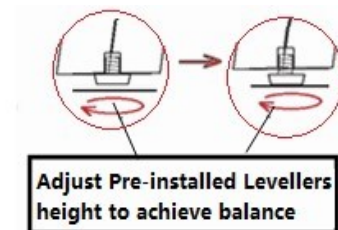
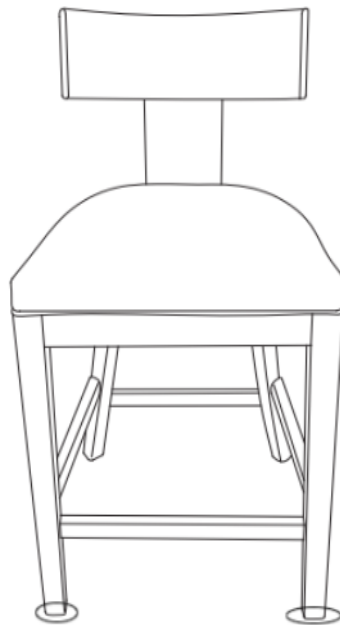

Turn the stool right side up.

Check for stability and then tighten all the remaining bolts.

DO NOT fully tighten a bolt in one go and then move on to the next.

Rather, in a sequential manner, gradually tighten each bolt until all bolts are evenly secured. This methodology will ensure maximum evenness once all bolts are fully tightened.

If the stool wobbles, adjust the Pre-installed Levellers at the bottom of the Legs until the stool is level.

Your stool is ready for use.

This Stool can only be used on a flat, level surface.