

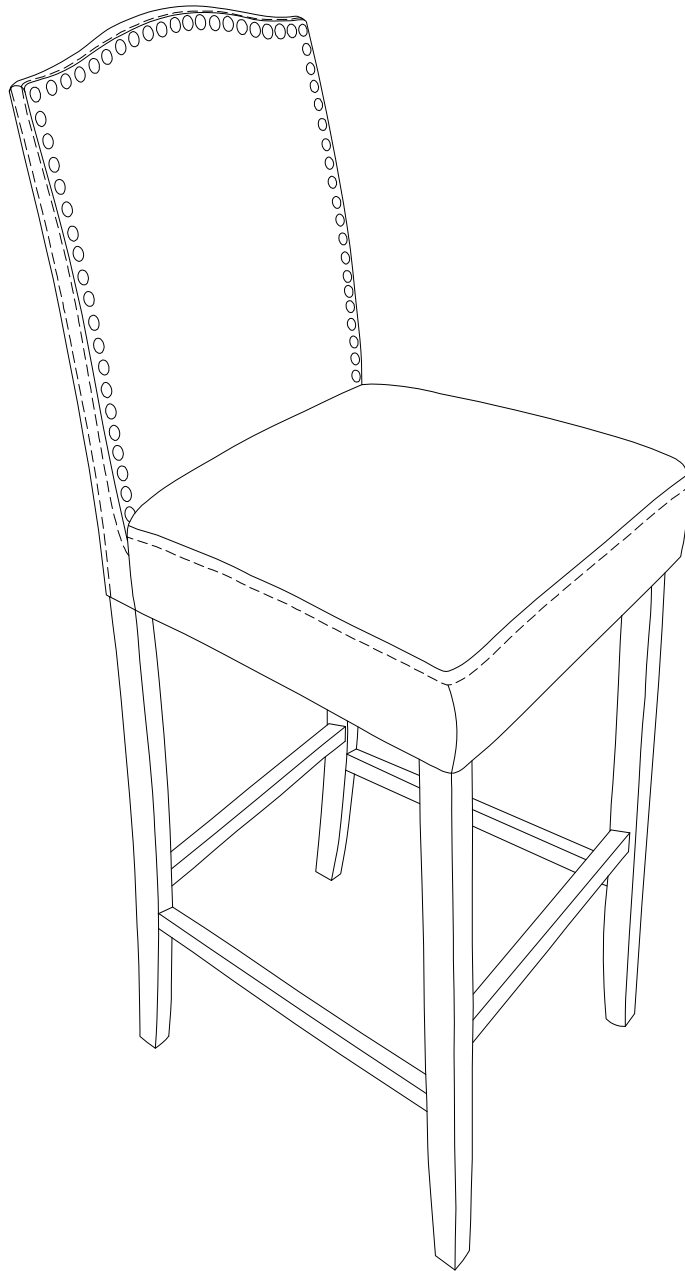





Assembly Instructions

Caution: You must read this before you proceed.

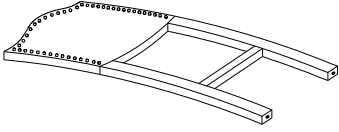



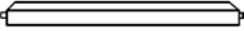



Bar Chair/Counter Chair



Parts List

Part NO.	Picture	Description	QTY
A		Chair Back	1 PC
B		Chair Seat	1 PC
C		Left Front Leg	1 PC
D		Right Front Leg	1 PC
E		Left Side Rail	1 PC
F		Right Side Rail	1 PC
G		Front Rail	1 PC

Hardware

Label	Picture	Description	QTY
1		Bolt(M6x80mm)	4 PCS
2		Bolt(M6x50mm)	4 PCS
3		Bolt(M6x45mm)	2 PCS
4		Screw(M4x38mm)	6 PCS
5		Spring Washer	10 PCS
6		Washer	10 PCS
7		Allen Key	1 PC
8		Screwdriver	Not provided

Assembly Preparation

Before Beginning Assembly:

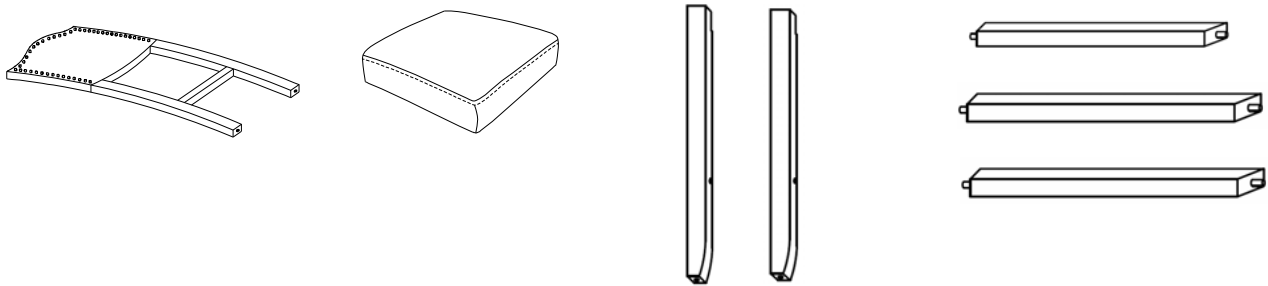

Pack A for assembling the Seat Frame(B) to the hind legs of Chair Back(A)	Bolt(M6x80mm)+ Washer +Spring Washer	
Pack B for assembling the Seat Frame(B) to the Front Leg Left(C) & Front Leg Right(D)	Bolt(M6x50mm)+ Washer +Spring Washer	
Pack C for assembling the Seat Frame (B) to the horizontal panel of Chair Back (A) at the central point	Bolt(M6x45mm)+ Washer +Spring Washer+ Allen Key	
Pack D for assembling the Left Side Rails(E) & Right Side Rails(F) to the Left Front Leg (C) & Right Front Leg (D)	Screw(M4x38mm)	
Pack E for assembling the Left Side Rails(E) & Right Side Rails(F) to the Chair Back (A)	Screw(M4x38mm)	
Pack F for assembling the Front Rail(G) to the Front Leg	Screw(M4x38mm)	



- Read instructions, cover to cover-



- Have 2 adults on hand for assembly-



- Do not assemble on flooring or carpet-



- Assemble on a clean non-marring surface (packing foam)-



- Save all packaging until finished-

Assembly Steps

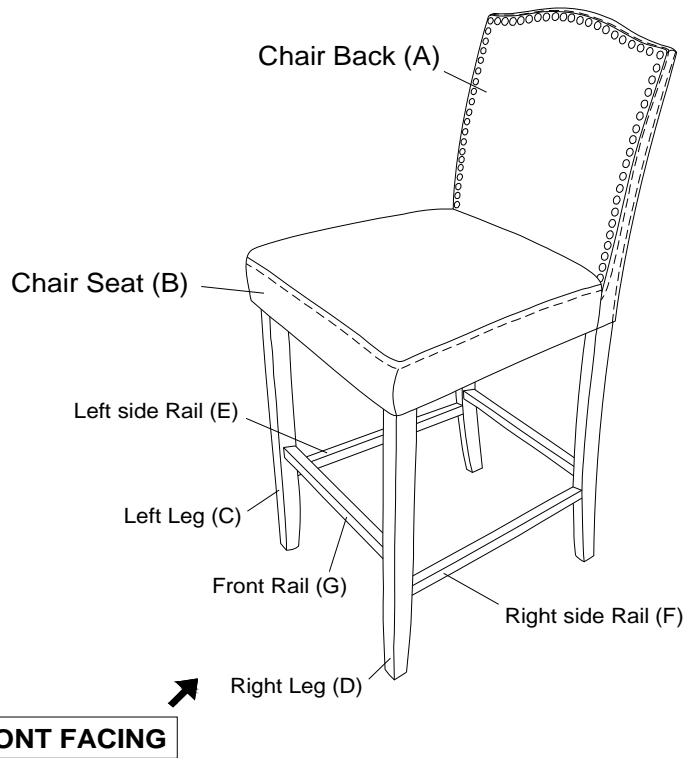

This Bar Chair has multiple parts and may require up to 30 minutes to assemble. To give you an overview of the Bookshelf parts, the above picture is to help you put the various Table parts into perspective.

Please read through the instructions herebelow to familiarise yourself with the parts and steps before assembly.

Step 1

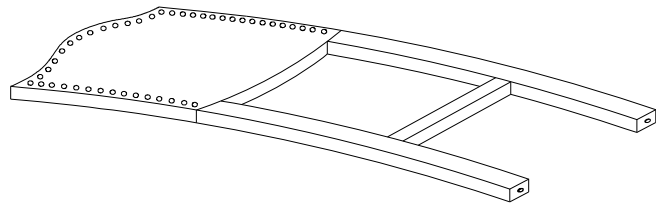

A. Chair Back

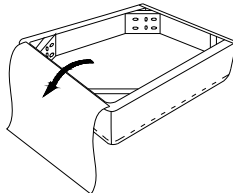

B. Chair Seat with Black Calico/magicTapes

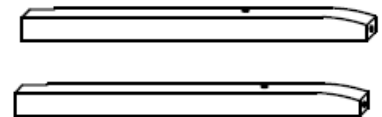

C. Front Left Leg & D. Front Right Leg

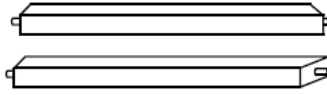

E. Left Side Rail & F. Right Side Rail

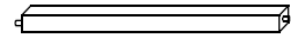

G. Front Rail

Place the Chair Back(A) and Chair Seat(B) on a clean, non-marring surface. Remove the Seat Base Cover from the underside of the Chair Seat(B) and take out all of the Parts and Hardware.

Step 2

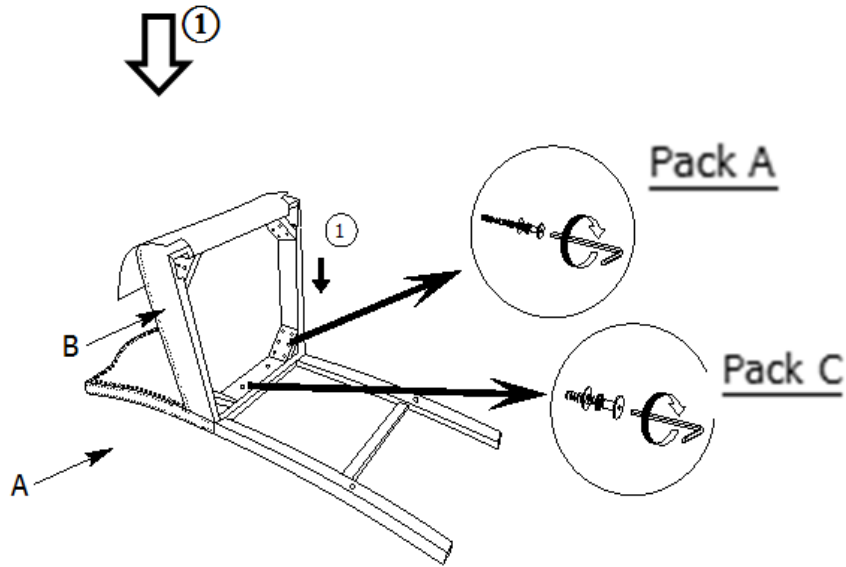

Align the mounting positions of the Chair Back(A) and Chair Seat Frame(B). Use your left hand to push the seat frame floorwards, depicted by Arrow 1, this action helps to ensure the Chair Seat(B) is pressed towards to the Chair Back(A) with no gap between them. Then, lock the middle mounting point by using Hardware Pack A and the corner mounting points by using Hardware Pack A & Pack C with The Allen Key(7),
Caution : At this stage, Do not fully tighten Bolts

Step 3

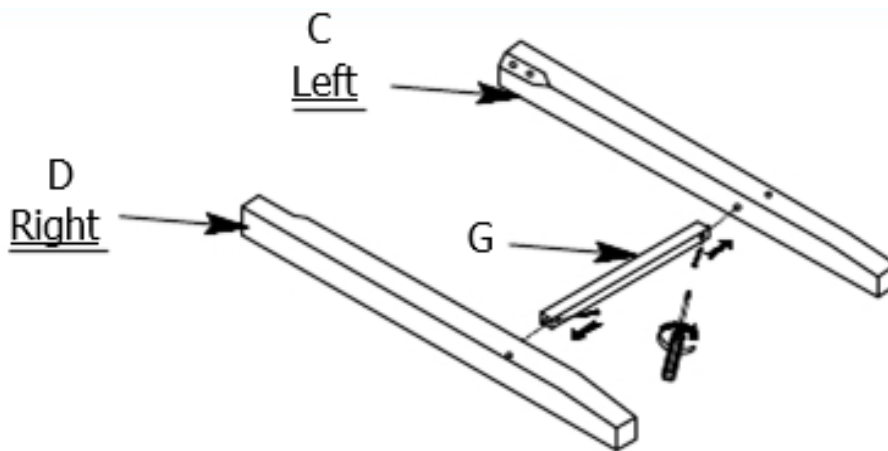

Insert the Front Rail(G) into the oval housing of Left Front Leg (C) & Right Front Leg (D) as shown above.
 Then, use Hardware Pack F to attach the Front Rail(G) to the Left Front Leg (C) & Right Front Leg (D).
 At this stage, Do not fully tighten Bolts

Step 4

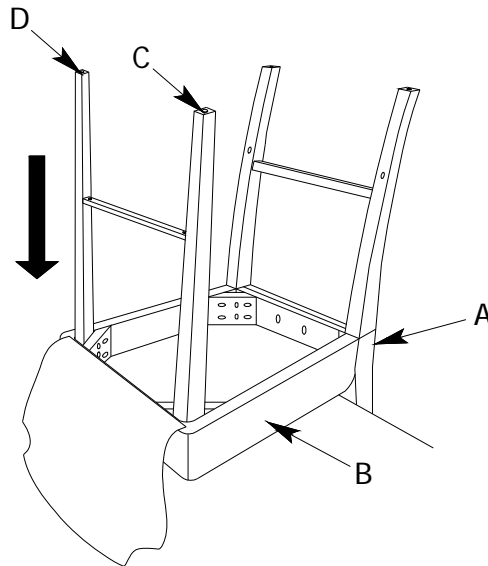

Place the chair onto the side of a table as seen in picture. Whith your assistant help to hold the front leg frame insert to the Chair Seat (B)

Step 5 Do not fully tighten the screws. Please make sure the right & left side rail with drill hole facing up as photo shown.

Step 5.1

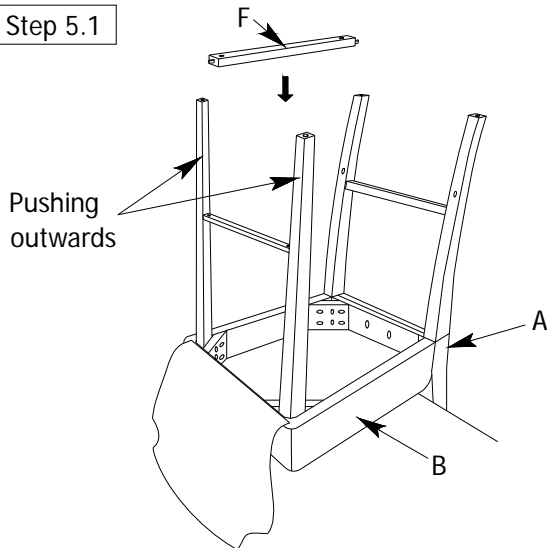

Step 5.2

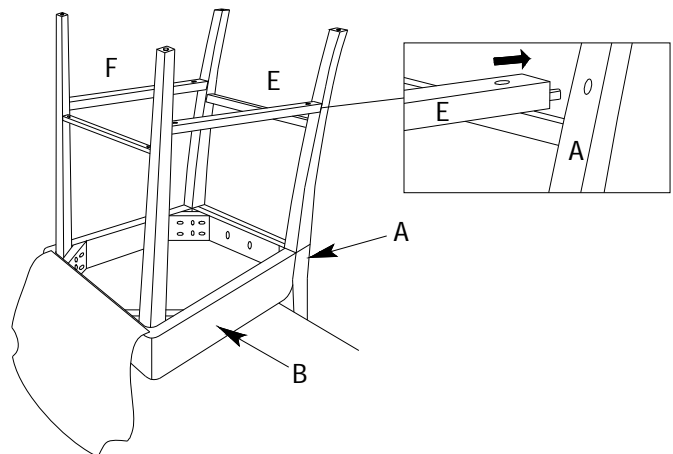

5.1 Place Right Side Rail (F) Into housing of the Hind Leg of the chair Black (A) And Right Leg (D).You may need to apply a little pressure to the front leg frame - pushing outwards, so as to enable the Side Rail (F) to be slotted into position.

5.2 Repeat the same proecess to install the Left Side Rail (E.)

5.3 Do not fully tighten the screws. Please make sure the right & left side rail with drill hole facing up as photo shown.

Step 6

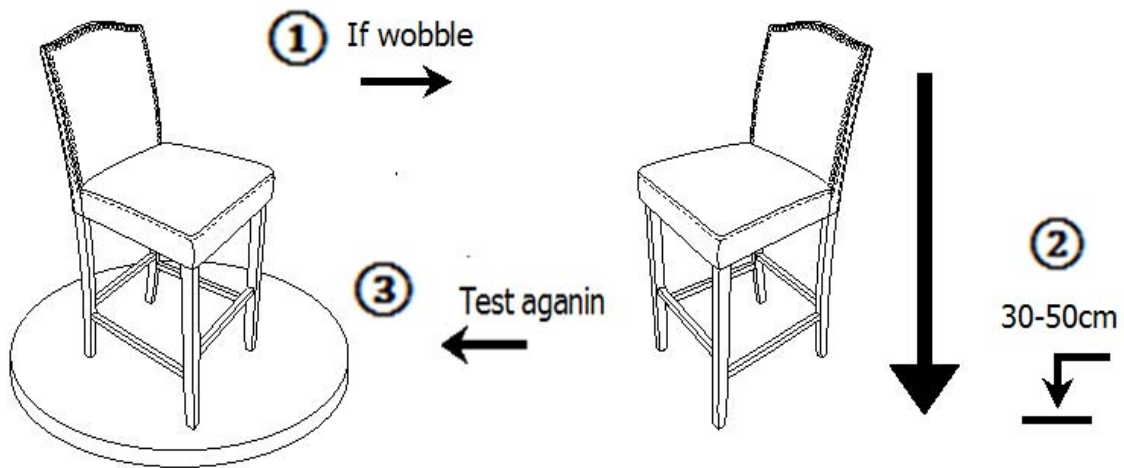

Place the chair on a Level Surface to check if it wobbles.

If it is wobbles, lift the chair some 30cm to 50cm high from the ground, keep your feet and toes well away from the drop zone, and drop the chair freely and vertically with the four legs, hitting the ground at the same time.

This **Drop Test** will help to ensure that all the bolts and gaps to all reach full alignment. test again for evenness on a **Level Surface**.

If no wobbles are found, proceed to tighten all the Bolts.

Caution: When tightening the Bolts, tighten sequentially.

Do not tighten any screw fully and then towards the next one, this would cause the frame to warp. If it still wobbles, loosen the bolts and execute this same drop test.

If the Chair is not Stable it could lead to damage to the product.

Step 7

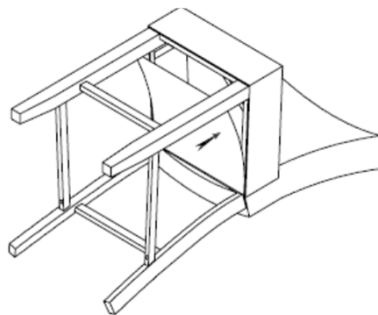

Place the Seat Base Cover back underneath the chair seat (as shown in picture) from where it was removed from originally.





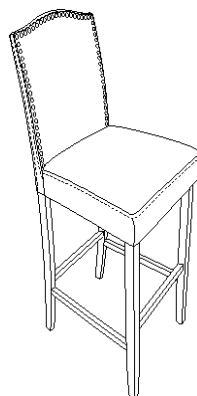













Smooth down with your hand on the Magic Tape on all 4 sides at the edge of the seat box.

Step 8



Turn the chair right way up, it is now ready for use.

Care & Maintenance

-   ● Do not put hot items directly on furniture surface
 -   ● Do not clean furniture with harsh cleansers or polish.
 -   ● Do not place furniture under direct sunlight.
 -   ● Do not place furniture near heating or cooling vents.
 -   ● Do not write on furniture without a padded barrier to protect the surface.
 -   ● Do not place furniture outside . For indoor use only .
 -   ● Not for commercial use. For residential use only .
 -   ● Stains may be removed with mild soap solution and damp cloth.
 -   ● Children should not climb or jump on the furniture.
-
-   ● Dust and pick-up spills using a clean, non-colored, lint-free cloth .

What is Proposition 65?

Proposition 65 is a California law that requires warning labels on products that may contain one of more than 800-plus chemicals or ingredients that the California Office of Environmental Health Hazard Assessment (OEHHA) has deemed to cause cancer or other reproductive toxicity. Chemicals and elements on this list include wood dust, brass, and other everyday substances, which can be found in very common household items, such as: lamps, tableware, jewelry, crystal glasses, electric cords, beauty products, automobiles, and furniture.

Why Did I Find a Proposition 65 Warning on My Home Goods Product?

We include Proposition 65 warnings on all of our products because there is always a chance that one of the 800-plus common chemicals and ingredients listed under this law could potentially be on our furniture or packing materials. We risk large fines under this law, if we don't include this warning.

Should I worry?

We realize you may be worried finding this warning on our products, but we want to reassure you that the hazardous exposure limits for any of these chemicals have never been found on furniture products that we've shipped to our customers. Additionally, this warning label is very common and can be found on almost every piece of furniture sold in the state of California.

Just How Common Are Proposition 65 Warnings?

Proposition 65 warnings have become so common in California that it is hard to take a trip to a local bank, grocery store, or restaurant without finding at least one warning. In fact, even the Disney Land Resort has a Proposition 65 warning:

