

Assembly Instructions

Caution: You must read this before you proceed.

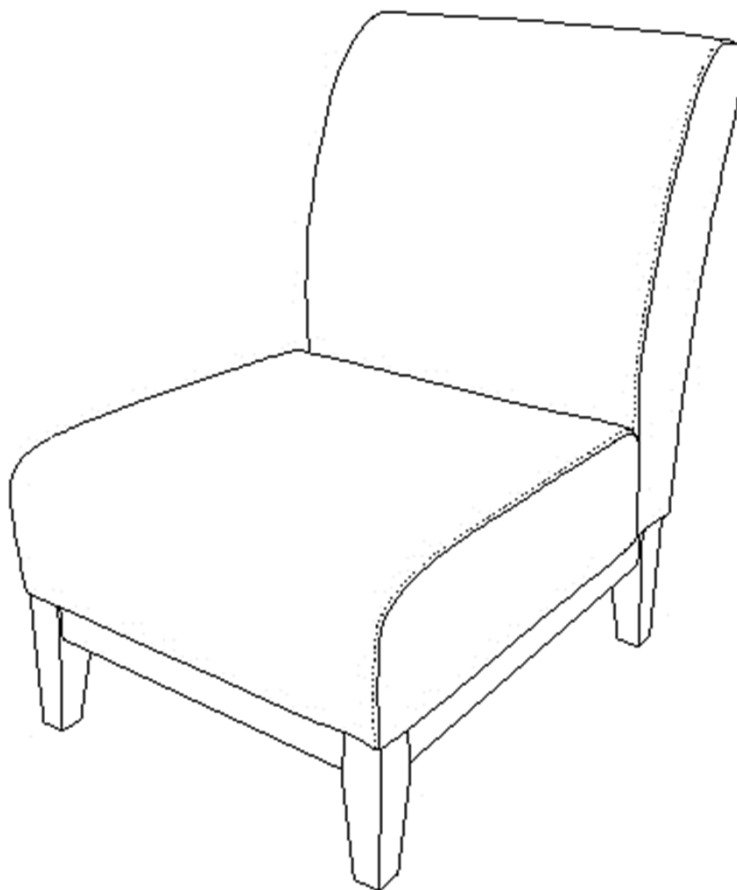



CHAIR

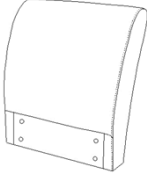
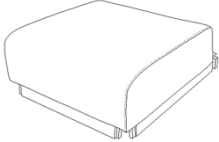
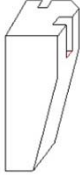





Parts List

Label	Picture	Description	Qty
A		Chair Back	1
B		Chair Seat	1
C		Wooden Legs	4

Hardware

Label	Picture	Description	Qty
a		Bolts M8X80mm	3
b		Bolts M8X60mm	9
c		Washers	11
d		Spring Washers	11
e		Allen Key	1

Assembly Preparation

-  • Read instructions, cover to cover-
-  • Have 2 adults on hand for assembly-
-  • Do not assemble on flooring or carpet-
-  • Assemble on a clean non-marring surface (packing foam)-
-  • Save all packaging until finished-

Assembly Steps

Step 1

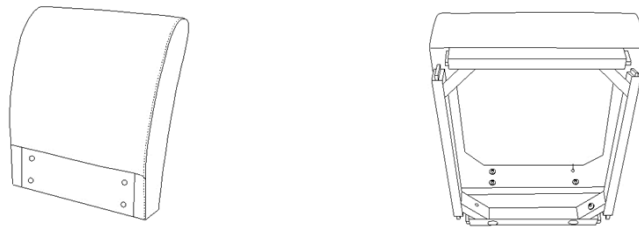

Place the Chair Back(A) and Chair Seat (B) on a soft surface to avoid any scratches or damages to the product.

REMOVE the non-woven fabric from the underside of the Chair Seat(B).

Take out the 4 wooden legs and the box of hardware.

Step 2

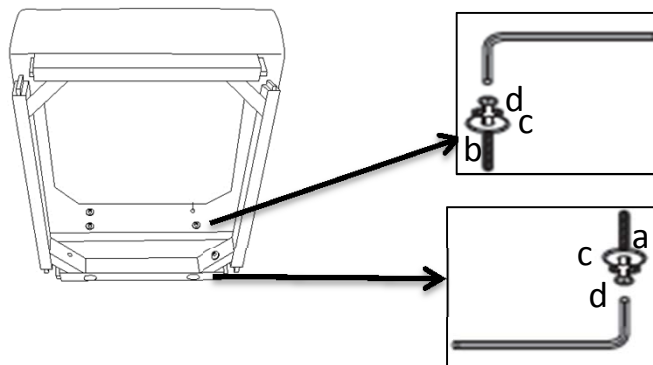

Afix the Chair Seat(B) to the Chair Back(A).

Align the mounting positions on the Chair Seat with the mounting positions on the Chair Back.

Fix the Chair Seat to the Chair Back by using 4 Bolts(b) and 2 Bolts(a)+ 6 Spring washers(d)+6 Washers(c) with Allen Key(e).

Step 3

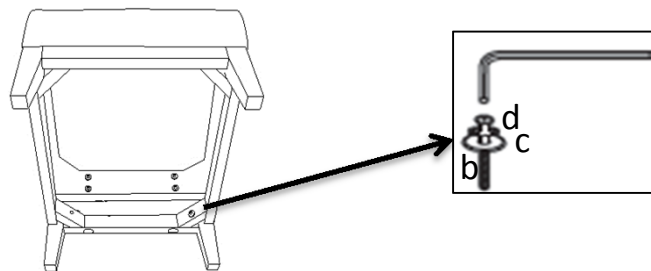

Afix the legs to the Chair Seat.

Fix the legs by using 4 Bolts(b)+4 Spring Washers(d)+4 Washers(c) with Allen Key(e).

Step 4

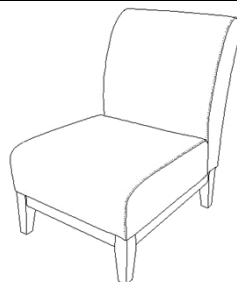

Turn the chair right side up.

Inspect and make sure all parts are connected, locked and fully secured into position.

The chair is ready to be used.

Care & Maintenance



● Do not put hot items directly on furniture surface.



● Do not clean furniture with harsh cleansers or polish.



● Do not place furniture under direct sunlight.



● Do not place furniture near heating or cooling vents.



● Do not write on furniture without a padded barrier to protect the surface.



● Do not place furniture outside. For indoor use only.



● Not for commercial use. For residential use only.



● Stains may be removed with mild soap solution and damp cloth.



● Dust and pick-up spills using a clean, non-colored, lint-free cloth.