

Assembly Instructions

Caution :You must read this before you proceed

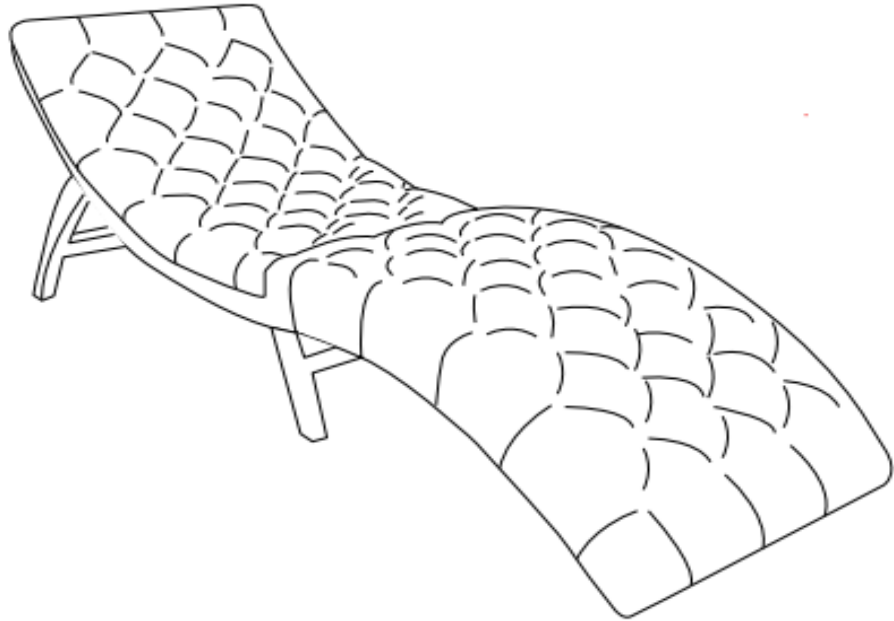

CHAISE

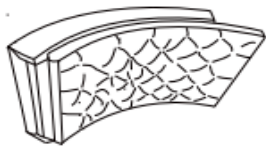

Parts List

| Label | Picture | Description | QTY |
|-------|---|-------------|-----|
| A |  | Chaise | 1 |

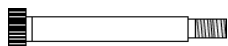
Hardware

| Label | Picture | Description | QTY |
|-------|---|----------------|-----|
| ① |  | Bolt (M6*55mm) | 4 |
| ② |  | Allen Wrench | 1 |

Assembly Preparation

Before
Beginning
Assembly:

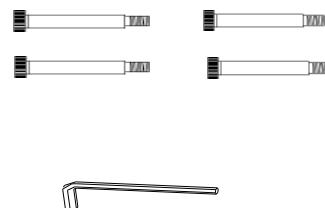
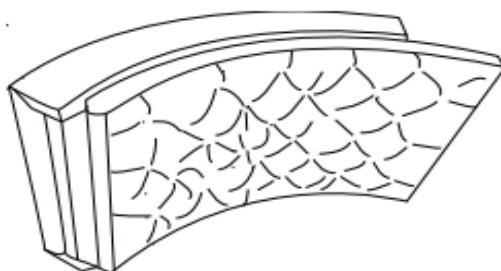

- Read instructions, cover to cover-



- Have 2 adults on hand for assembly-



- Do not assemble on flooring or carpet-



- Assemble on a clean non-marring surface (packing foam)-



- Save all packaging until finished-

Assembly Steps

OVERVIEW

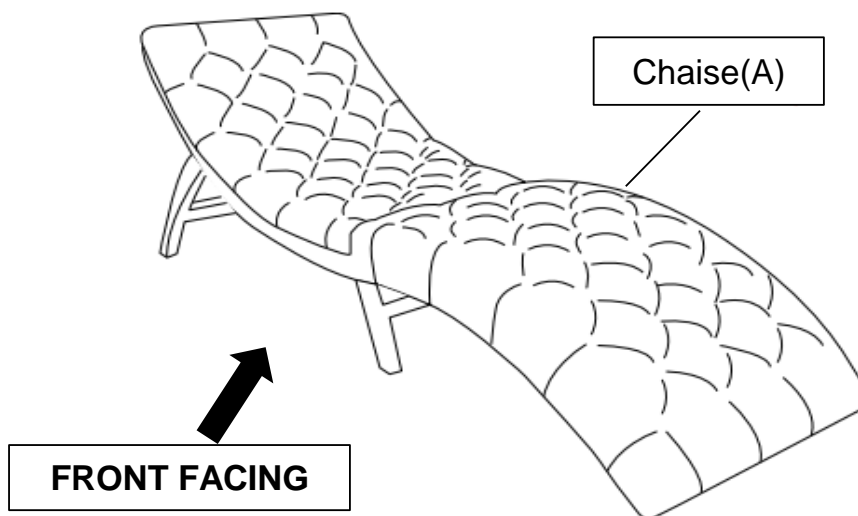

This Chaise has multiple parts and may require up to 30 minutes to assemble. To give you an overview of the Chaise parts, the above picture is to help you put the various Chaise parts into perspective. Please read through the instructions to familiarise yourself with the parts and steps before assembly.

Step 1

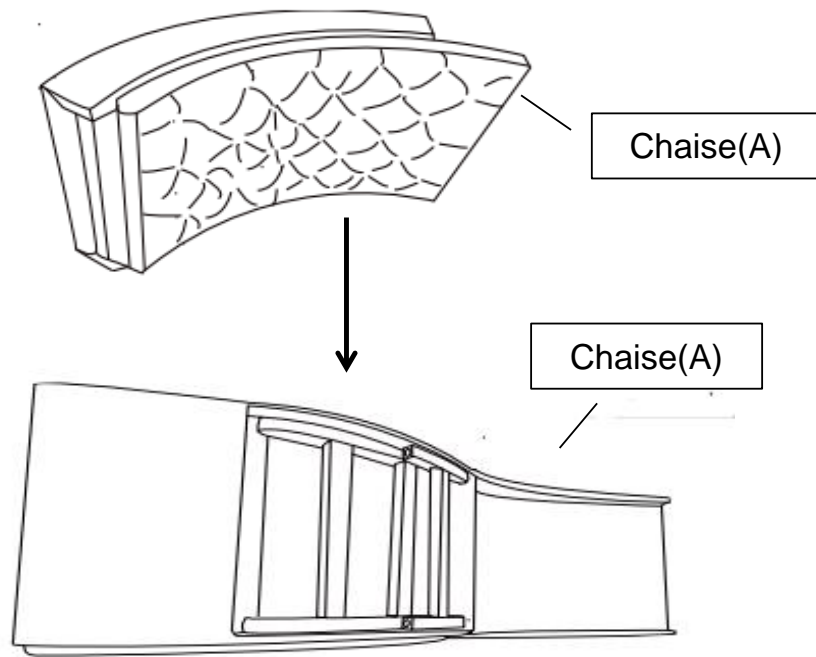

Position the Chaise(A) on a clean, non-marring surface, as shown.
Put the folded chaise open as shown.

Step 2

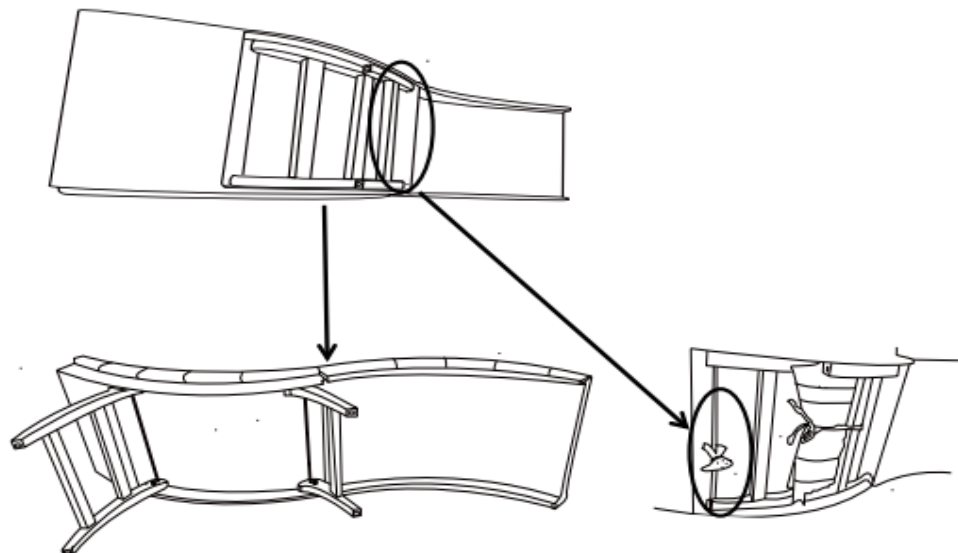

Respectively to pull the two feet out as shown.
And remove the hardware package from the feet.

Step 3

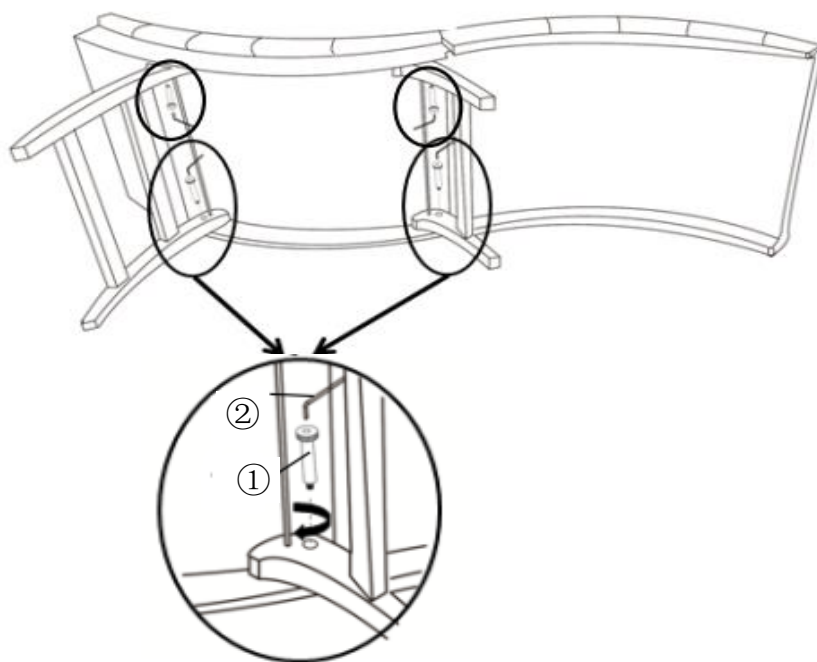

Fixed the leg with Bolts(①), with Allen Wrench(②),as shown,in order to ensure the product stability.

Step 4

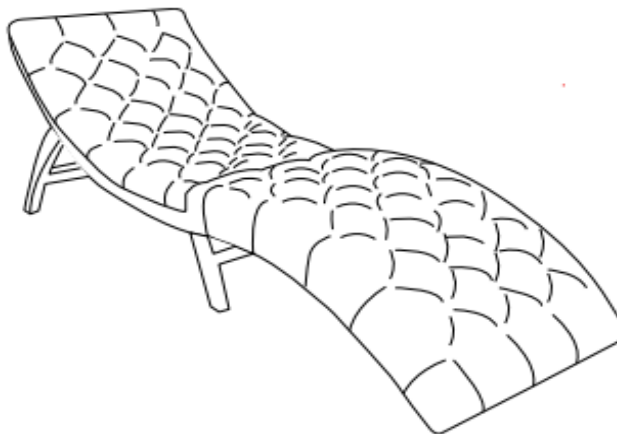

Stand the Chaise right side up.
Make sure all parts are connected and securely locked into position.
Your Chaise is ready for use.
Caution :This Chaise can only be used on a flat, level surface.

Care & Maintenance



- Furniture may scratch floors. We recommend using furniture pads to protect your floors.



- Do not put hot items directly on furniture surface.



- Do not clean furniture with harsh cleansers or polish.



- Do not place furniture under direct sunlight.



- Do not place furniture near heating or cooling vents.



- Do not write on furniture without a padded barrier to protect the surface.



- Do not place furniture outside . For indoor use only.



- Not for commercial use. For residential use only.



- Stains may be removed with mild soap solution and damp cloth.



- Children should not climb or jump on the furniture.



- Dust and pick-up spills using a clean, non-colored, lint-free cloth.