

Assembly Instructions

CAUTION: You must read this before you proceed.

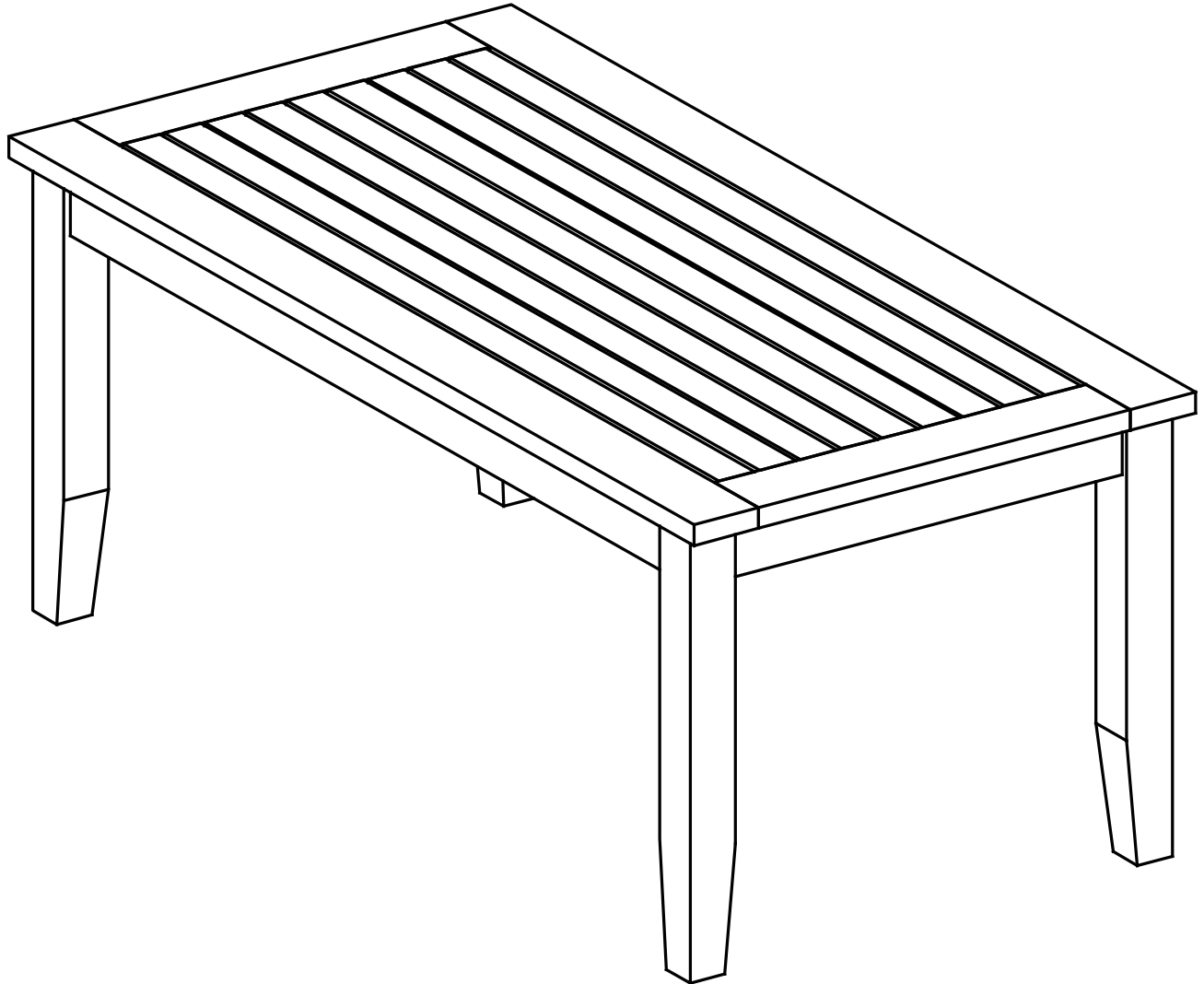

Please look in the Table Top for hardware packs.

TABLE



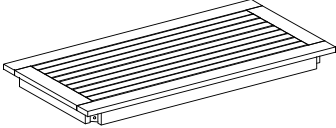

CAUTION: This Table is NOT a TOY.
Keep your child / children at bay in the process of assembly.
For turning the Table and to prevent damage to the Table, 02 people may be needed to execute this action.

Parts List

No.	Picture	Description	Qty
A		Table Top	1
B		Legs	4

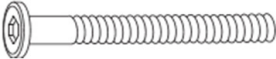



Hardware

No.	Picture	Description	Qty
①		Bolts (M6 x 50mm)	9
②		Flat Washers (M6xD1.5mm)	9
③		Allen Wrench	1

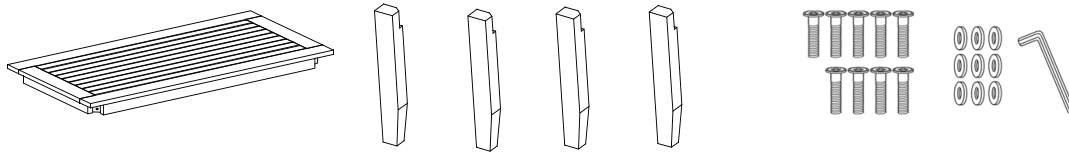
Assembly Preparation

Before Beginning Assembly:



-  Read instructions, cover to cover.
-  Have 2 adults on hand for assembly.
-  Do not assemble on flooring or carpet.
-  Assemble on a clean non-marring surface (packing foam).
-  Save all packaging until finished.

Assembly Steps

OVERVIEW

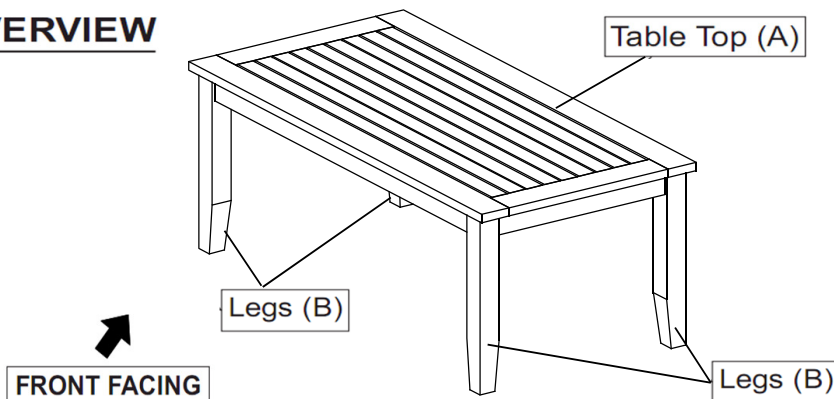

This Table has multiple parts and may require up to 30 minutes to assemble.

To give you an overview of the Table parts, the above picture is to help you put the various parts into perspective.

Please read through the instructions herebelow to familiarise the parts and steps before assembly.

Step 1

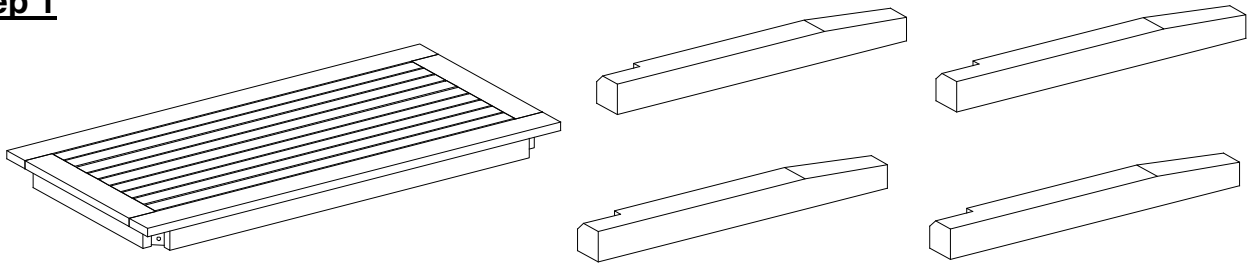

Unpack and place all parts on a clean, non-marring surface.

Step 2

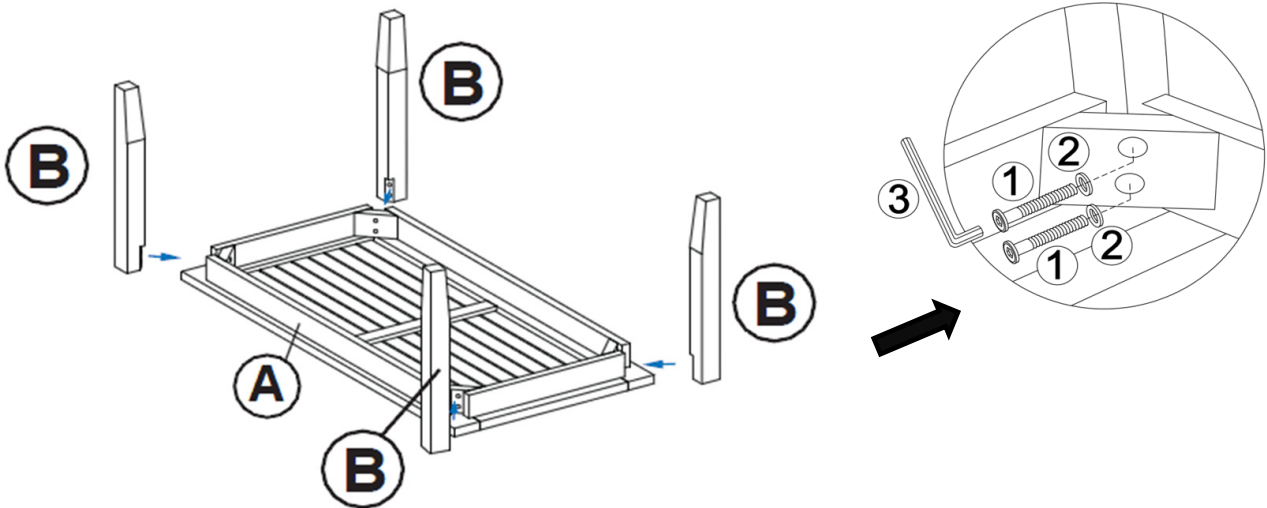

Place the Table top (A) with its underside skywards onto a clean, soft surface to avoid any scratch or damage to the product.

Affix loosely the Legs (B) into the mounting position at the corners of the Table Top (A), using the Bolts (①) with Flat Washers (②), and Allen Wrench(③), as shown in the picture.

Repeat the same process with the other Legs (B).

CAUTION: When tightening these screws, tighten sequentially.

DO NOT tighten any screw fully and then towards the next one.

This would cause the frame to warp.

WARNING ! IF END TABLE IS NOT STABLE , IT COULD LEAD TO DAMAGING THE PRODUCT.

Step 3

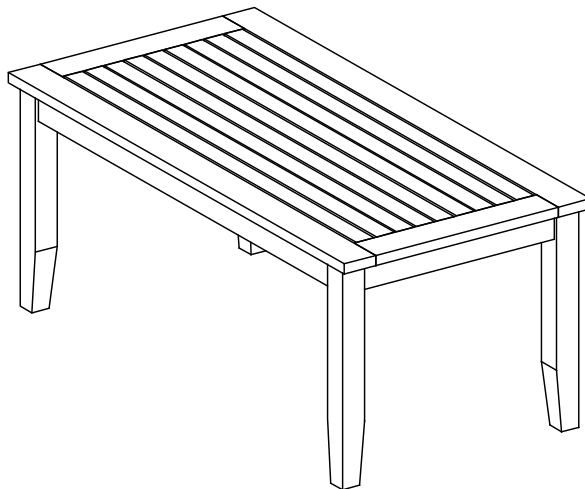



















Ensure all bolts are fully locked into position.

The Table is ready to be used.

Caution: This Table can only be used on a flat, level surface.

Care & Maintenance

-   ● Do not put hot items directly on furniture surface
 -   ● Do not clean furniture with harsh cleansers or polish.
 -   ● To obtain the longest life span of your outdoor products, minimizing exposure to direct sunlight is recommended.
 -   ● Children should not climb or jump on the furniture.
 -   ● Do not write on furniture without a padded barrier to protect the surface.
 -   ● To obtain the longest lifespan of your outdoor products, avoid extended and lengthy exposure to rain, snow, and direct sunshine. Whenever possible cover the product and /or place under patio or awnings.
 -   ● Not for commercial use. For residential use only .
 -   ● Stains may be removed with mild soap solution and damp cloth.
-
-   ● Dust and pick-up spills using a clean, non-colored, lint-free cloth .