

Assembly Instructions

Caution : You must read this before you proceed

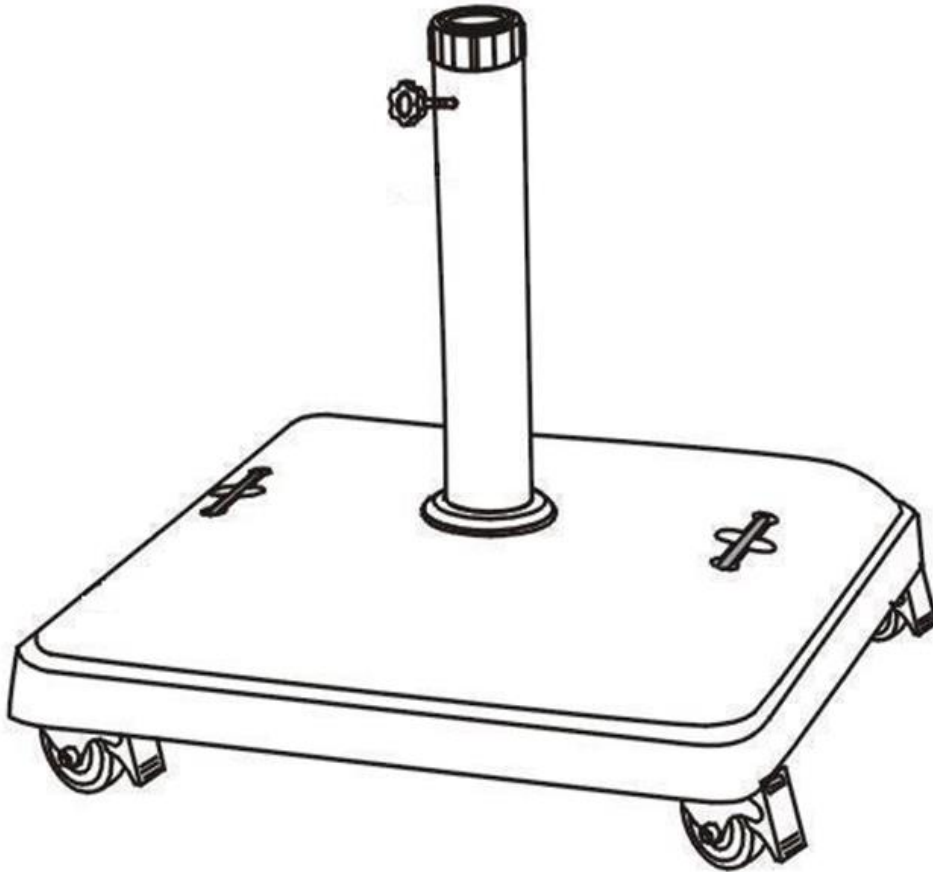

Remind: Umbrella open diameter max. 11 feet





Umbrella Base

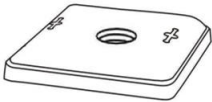

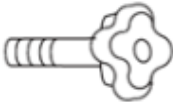
Umbrella Base Weight : 84lbs

Parts List

Label	Picture	Description	QTY
A		Umbrella Base	1
B		Support Pole	1
C		Adjustable Screw	1

D		Cap	1
E		Adapter for 38mm Pole	1
F		Adapter for 48mm Pole	1
G		Wheel	4

Assembly Preparation

Before Beginning Assembly:

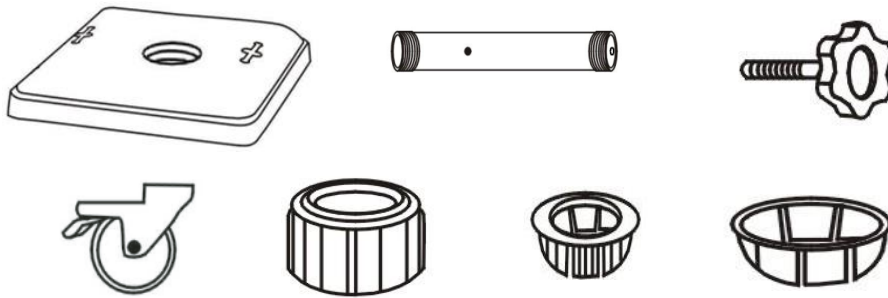

- Read instructions, cover to cover-



- Have 2 adults on hand for assembly-



- Do not assemble on flooring or carpet-



- Assemble on a clean non-marring surface (packing foam)-



- Save all packaging until finished-

WARNING: CHOKING HAZARD. Do not allow children to play with plastic wraps or any small parts in this package.

Notice: As a safety precaution, when your Umbrella is not in use, please close the Umbrella.

Remove Umbrella from this Base and store in safe location

ATTENTION: This Umbrella Base is exclusively recommended to be used together under a table with the matching umbrella with diameter of 11 feet.

The matching Support Pole diameter: 38mm - 48mm.

Assembly Steps

Overview

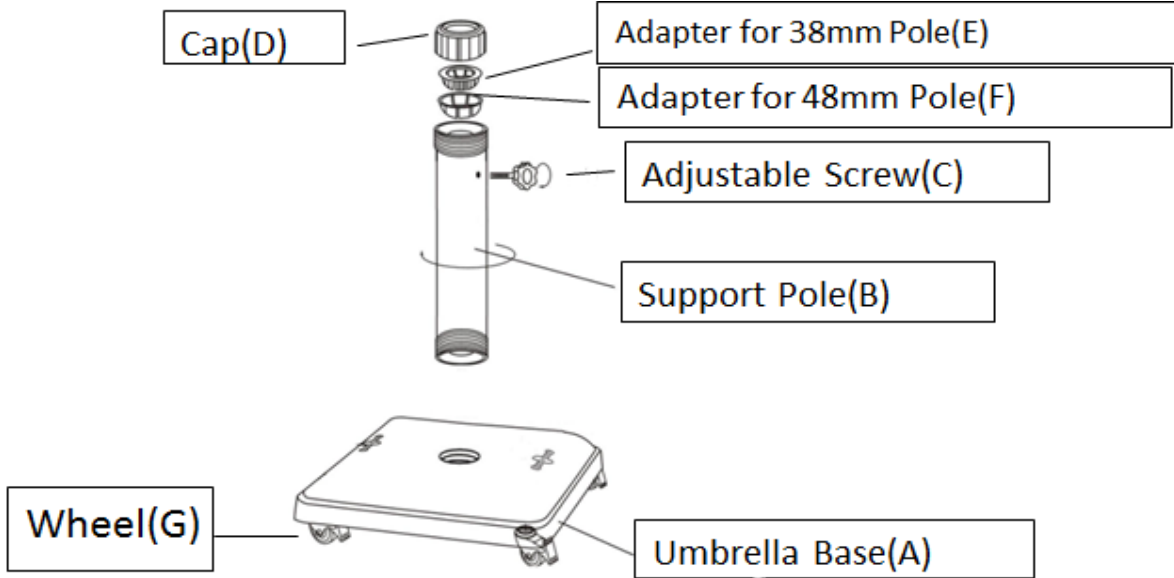

This Umbrella Base has multiple parts and may require up to 30 minutes to assemble. To give you an overview of the Umbrella Base parts, the above picture is to help you put the various parts into perspective. Please read through the instructions below to familiarise yourself with the parts and steps before assembly.

Step 1

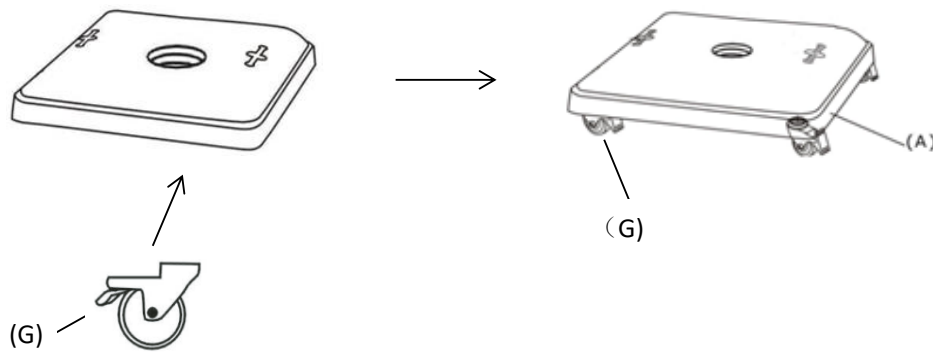

This is a two person team assembly product.

Attach Wheels(G) to Umbrella Base(A) by inserting the threaded stem of the Wheels and turning clockwise until secure. Press on the brake to make the base in a fixed position.

Step 2-A

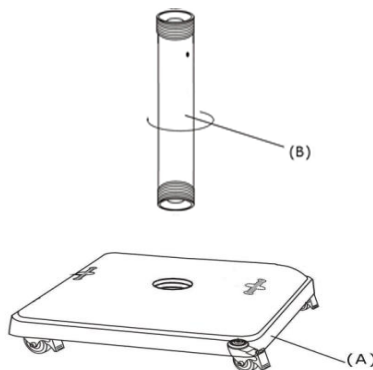

Then screw Support Pole(B) into Umbrella Base(A).

Step 2-B

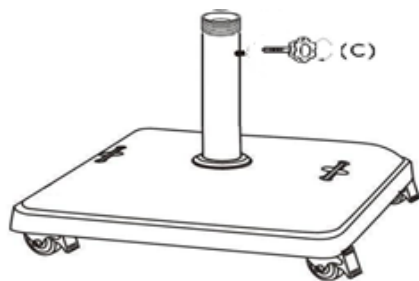

Screw Adjustable Screw(C) into Support Pole(B).

Step 3 - A

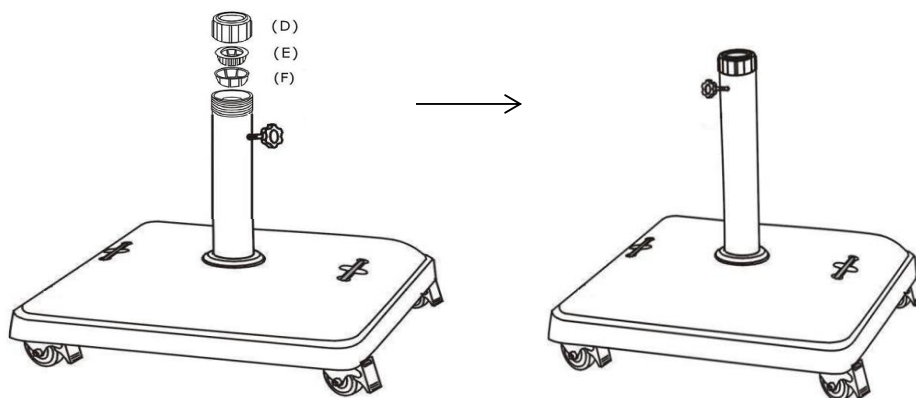

Used for Umbrella Pole with 38mm diameter.

Insert Adapter for 48mm Pole(F) into the Support Pole(B) first, then put the Adapter for 38mm Pole(E) onto the Adapter for 48mm Pole(F).

Turn the Cap(D) onto the Support Pole(B) to lock the Adapters in place. Press on the brake to make the base in a fixed position.

Your Umbrella Base is ready for use.

This Umbrella Base only be used on a flat, level surface.

Step 3 - B

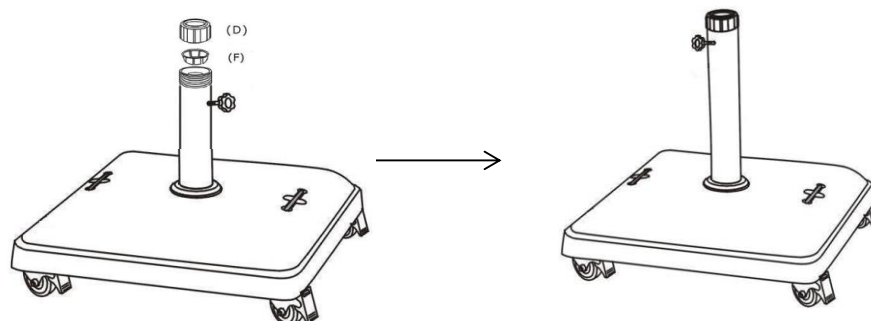

Used for Umbrella Pole with 48mm diameter.



















Insert Adapter for 48mm Pole(F) into the Support Pole(B).

Turn the Cap(D) onto the Support Pole(B) to lock the Adapter in place. Press on the brake to make the base in a fixed position.

Your Umbrella Base is ready for use.

This Umbrella Base only be used on a flat, level surface.

Care & Maintenance

-   ● Do not put hot items directly on furniture surface
 -   ● Do not clean furniture with harsh cleansers or polish.
 -   ● To obtain the longest lifespan of your outdoor products, minimizing exposure to direct sunlight is recommended.
 -   ● Children should not climb or jump on the furniture.
 -   ● Do not write on furniture without a padded barrier to protect the surface.
 -   ● To obtain the longest lifespan of your outdoor products, avoid extended and lengthy exposure to rain, snow, and direct sunshine. Whenever possible cover the product and /or place under patio or awnings.
 -   ● Not for commercial use. For residential use only .
 -   ● Stains may be removed with mild soap solution and damp cloth.
-
-   ● Dust and pick-up spills using a clean, non-colored, lint-free cloth .