

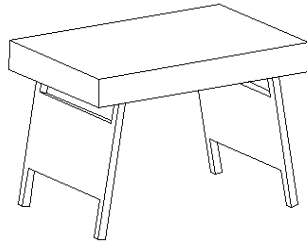

Assembly Instructions

Caution : You must read this before you proceed

Snack Table



Part List

Label	Picture	Description	QTY
A		Snack Table	1

Hardware

Label	Picture	Description	QTY
①		Bolt (M6*35mm)	3

Assembly Preparation

Before Beginning Assembly:

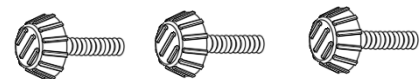
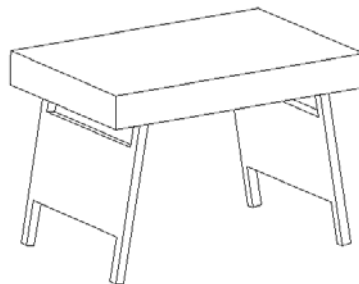

- Read instructions, cover to cover-



- Have 2 adults on hand for assembly-



- Do not assemble on flooring or carpet-



- Assemble on a clean non-marring surface (packing foam)-



- Save all packaging until finished-

Assembly Steps

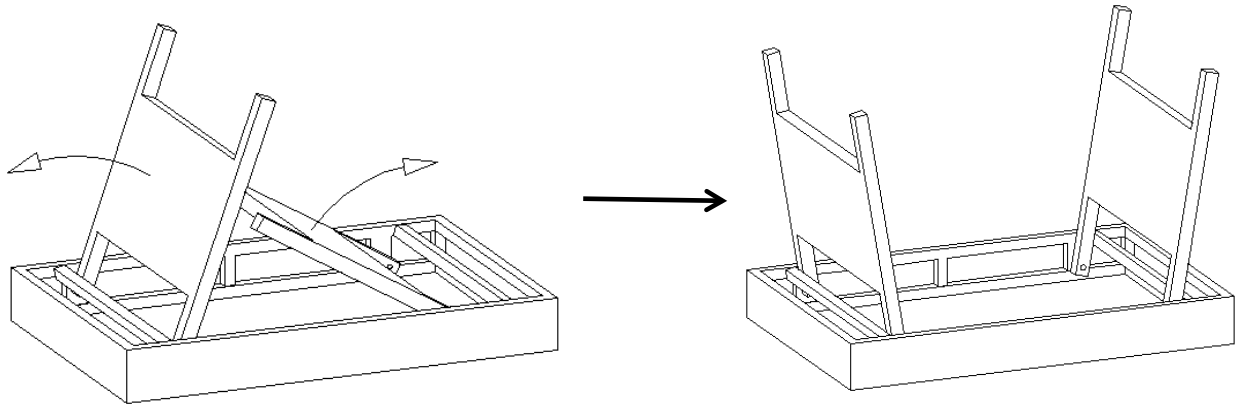

Open the carton and place the Snack Table onto a clean, non-marring surface as shown in Picture

Step 1

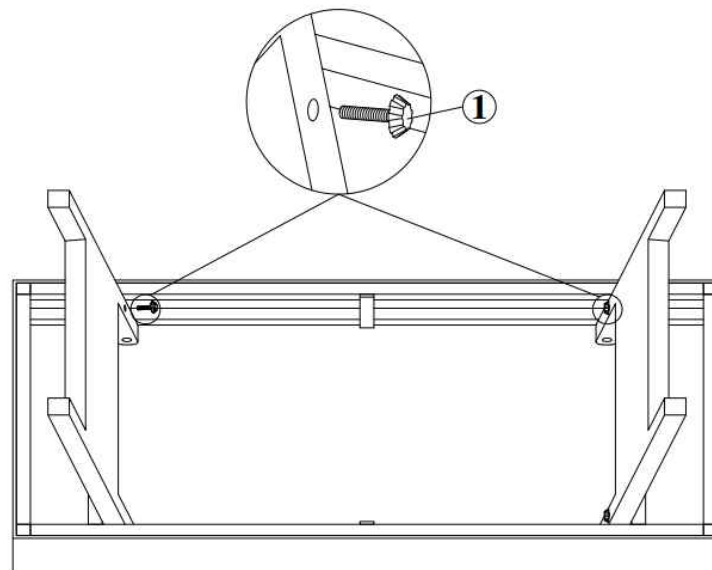





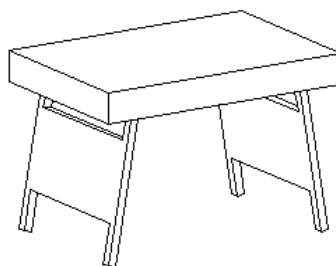















Attach the Table Leg onto the support bar on the table top using Bolt (1) as above picture show.
Fully tighten the Bolts.

Step 2



Turn the Snack Table up.
Your Snack Table is ready for use.
This Snack Table can only be used on a flat, level surface.

Care & Maintenance

-   ● Do not put hot items directly on furniture surface
-   ● Do not clean furniture with harsh cleansers or polish.
-   ● To obtain the longest lifespan of your outdoor products, minimizing exposure to direct sunlight is recommended.
-   ● Children should not climb or jump on the furniture.
-   ● Do not write on furniture without a padded barrier to protect the surface.
-   ● To obtain the longest lifespan of your outdoor products, avoid extended and lengthy exposure to rain, snow, and direct sunshine. Whenever possible cover the product and /or place under patio or awnings.
-   ● Not for commercial use. For residential use only .
-   ● Stains may be removed with mild soap solution and damp cloth.
-   ● Keep away from sources of ignition.
-   ● Dust and pick-up spills using a clean, non-colored, lint-free cloth.