

Assembly Instructions

Caution : You must read this before you proceed.







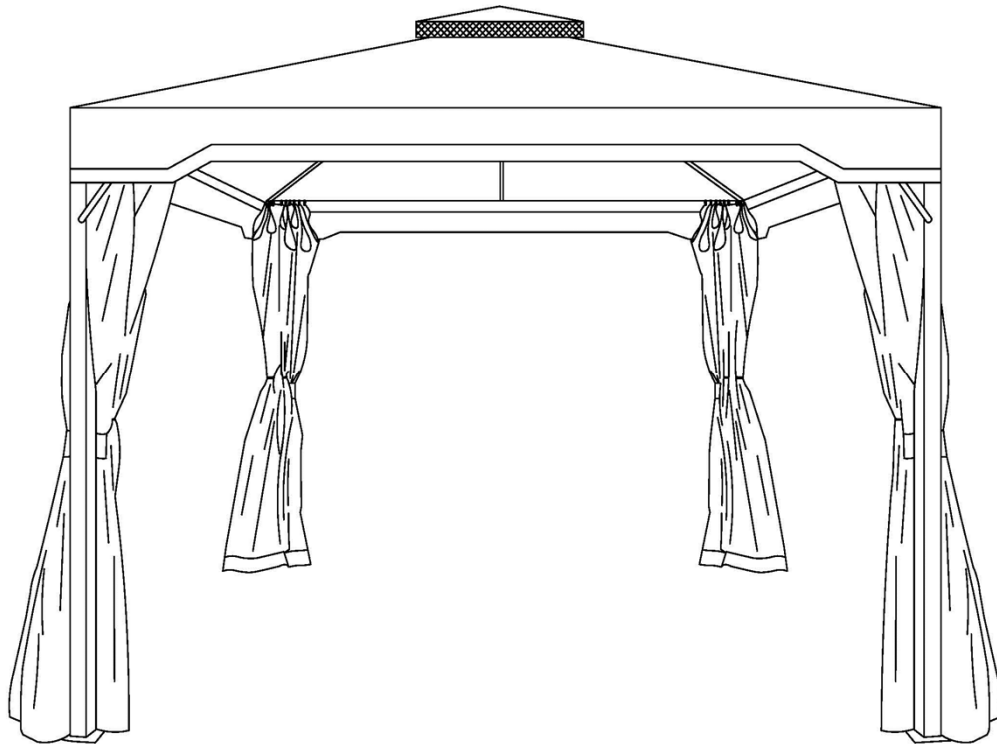

Read all instructions before assembling and using this product

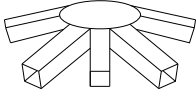
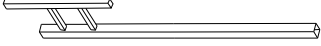
1. Select ideal location. Set out all parts on a clear and level surface prior to assembly. Ideally, the Gazebo should be set up in the desired location to avoid moving it after assembly.
2. Team Work. We recommend 4-5 adults and it may require 3 to 4 hours to fully assemble the Gazebo. If possible, please use safety ladders.
3. Use caution. During the entire assembly process, especially when lifting heavy or large parts or using ladders, pay attention to safety. No one other than those assistants should be allowed in the work area.
4. Check all available parts. Before assembling your Gazebo Frame, make sure that you have all the parts described in the Parts List.
5. Ensure that ALL BOLTS are fully and securely bolted in before you proceed to attach the Canopies.
6. Keep children away. Children shouldn't be allowed in the work area. Do not let them handle parts and tools. Do not allow children to climb the Gazebo.
7. It is recommended that the canopy, sidewall and mosquito netting be removed during strong windy conditions.

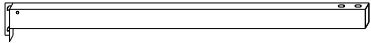
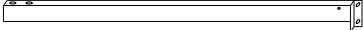
Gazebo

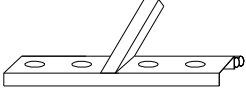
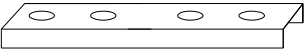

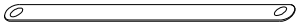

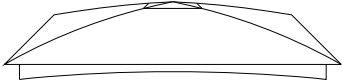
Parts List

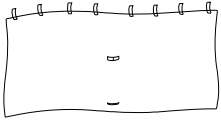
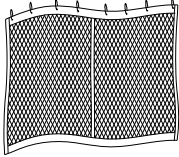
Label	Picture	Description	QTY
A		Crown Center Connector	1
B		Long Top Bar	4
B1		Connection Tube	4
C		Short Top Bar	4
D1		Crossbar	4
D2		Crossbar	4
E		Main Pillar	4
F1		T Shape Connector	4
F2		U Shape Connector	4
G		Sliding Rail	16
H		Connection Piece	8
N		Vent Canopy	1
O		Canopy	1

P		Curtain	4
Q		Mosquito Netting	4

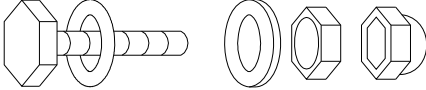
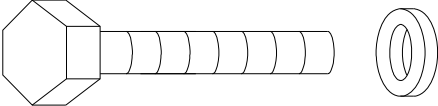
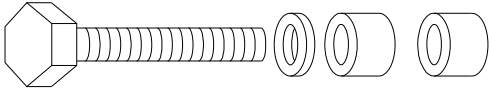
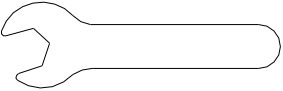
Hardware

Label	Picture	Description	QTY
S		Bolt(M6*72mm)\Flat Washer\ Nut\ Plastic Nut Cap	18
T		Bolt(M6*15mm)\Flat Washer	40
X		Bolt(M6*60mm)\Flat Washer\plastic gasket	9
Z		Wrench	4
U		Plastic Ring	78
V		Stake	8

Assembly Preparation

Before Beginning Assembly:

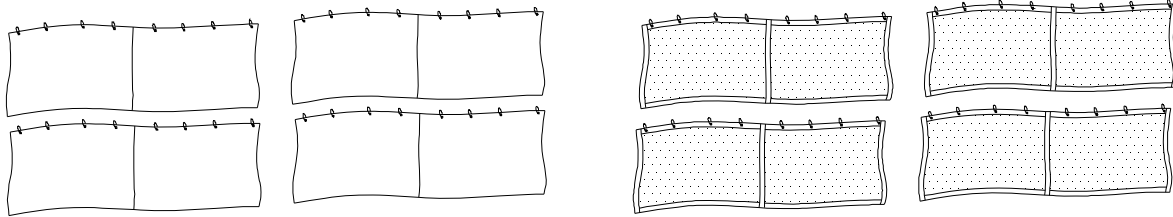
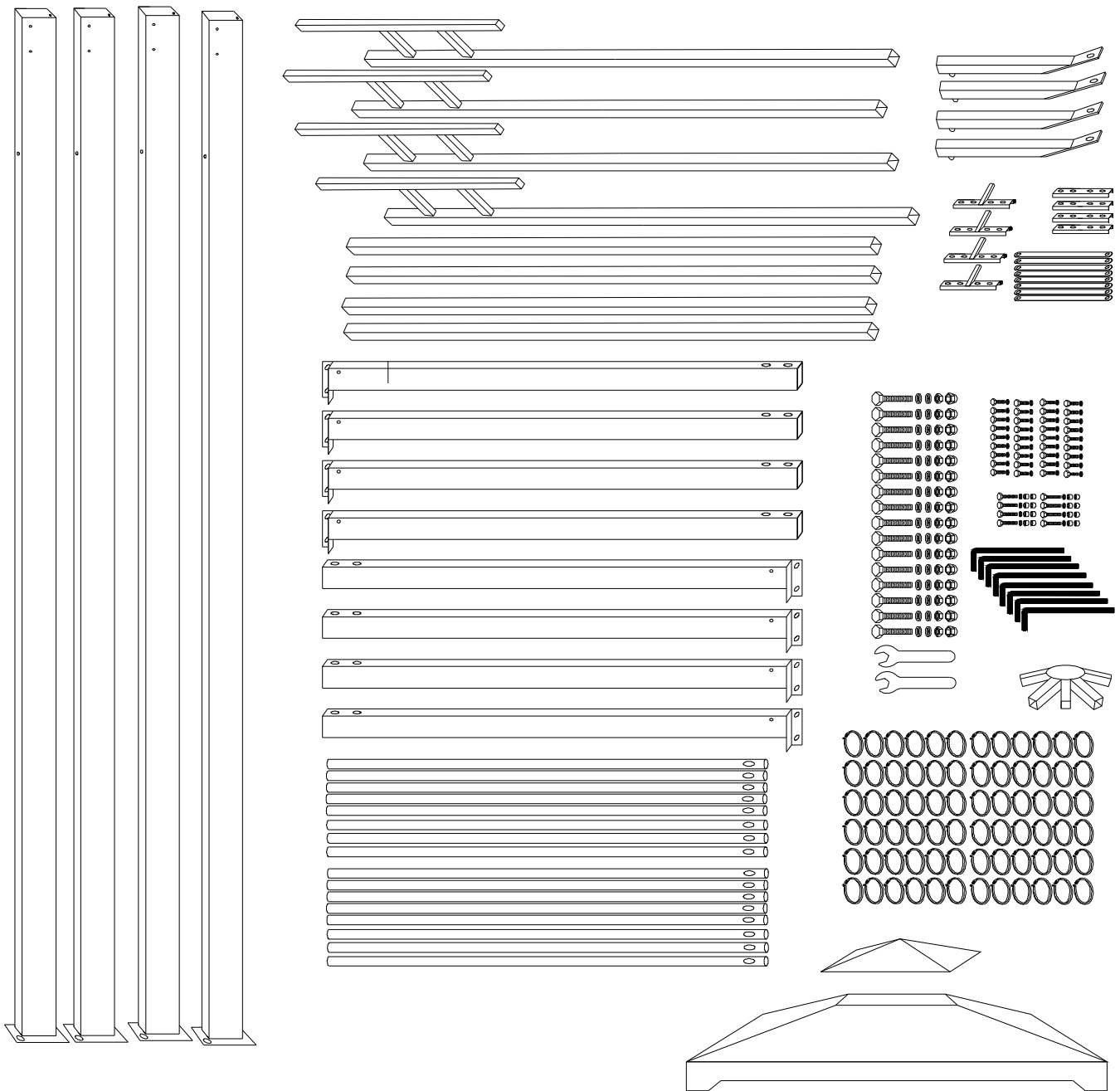

- Read instructions, cover to cover-



- Have 4-5 adults on hand for assembly-



- Do not assemble on flooring or carpet-



- Assemble on a clean non-marring surface (packing foam)-



- Save all packaging until finished-

Assembly Steps

Step 1

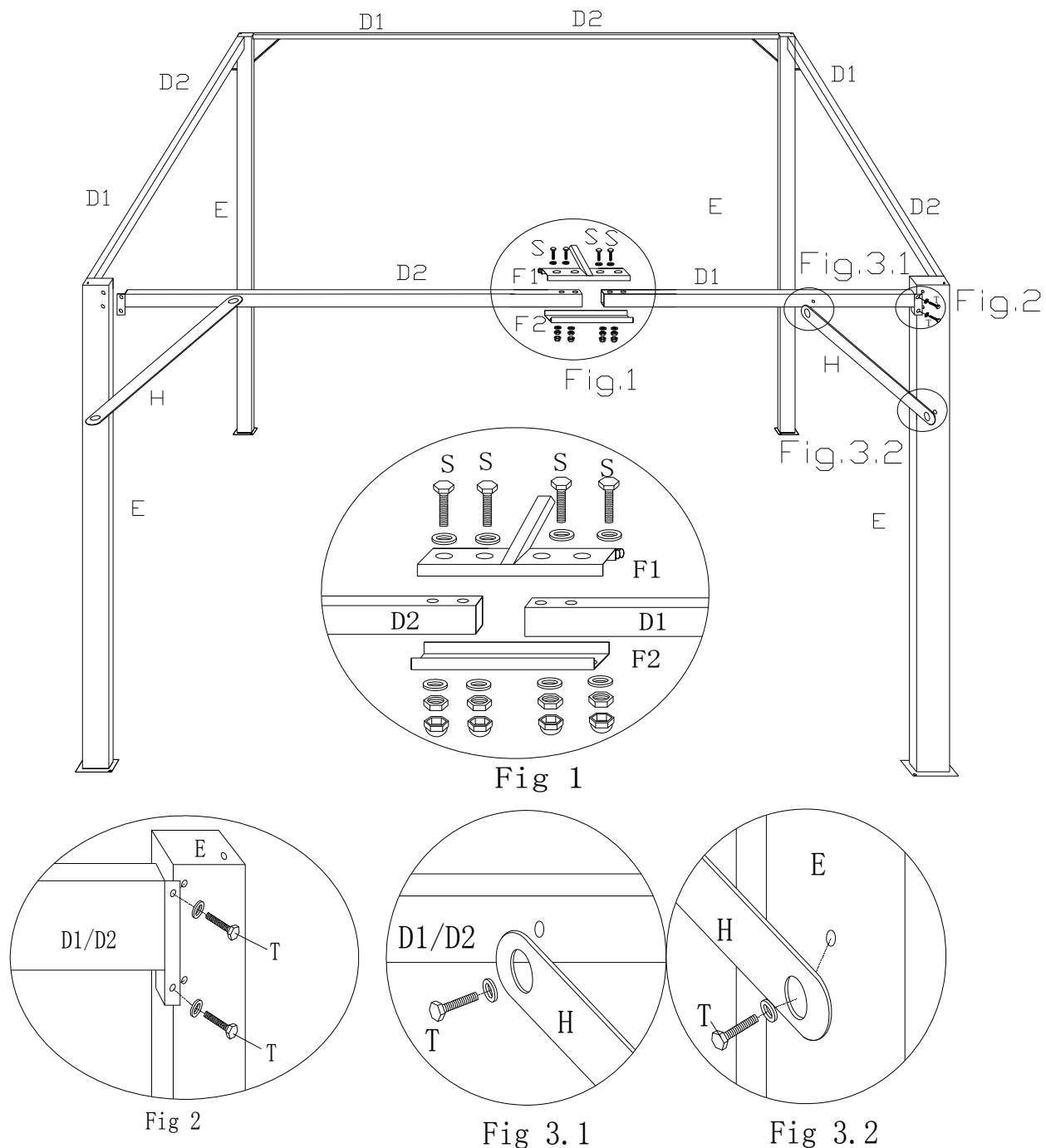

Attach the U Shape Connector(F2) and T shape Connector(F1) to the Crossbars(D1, D2) using Hardware(S) with Wrenches(Z). (See Fig. 1)

Please note the T shape Connector(F1) should be on top.

Attach the assembled Crossbar(D1, D2) to Post(E) using Hardware(T) with Wrenches(Z). (See Fig. 2) **Note the T Shape Connector(F1) should be angled inwards.**

Attach the Connection Piece(H) to the Crossbar(D1, D2) and Post(E) using Hardware(T) with Wrenches(Z). (See Fig. 3.1&3.2)

DO NOT OVERTIGHTEN BOLTS at this step.

Step 2

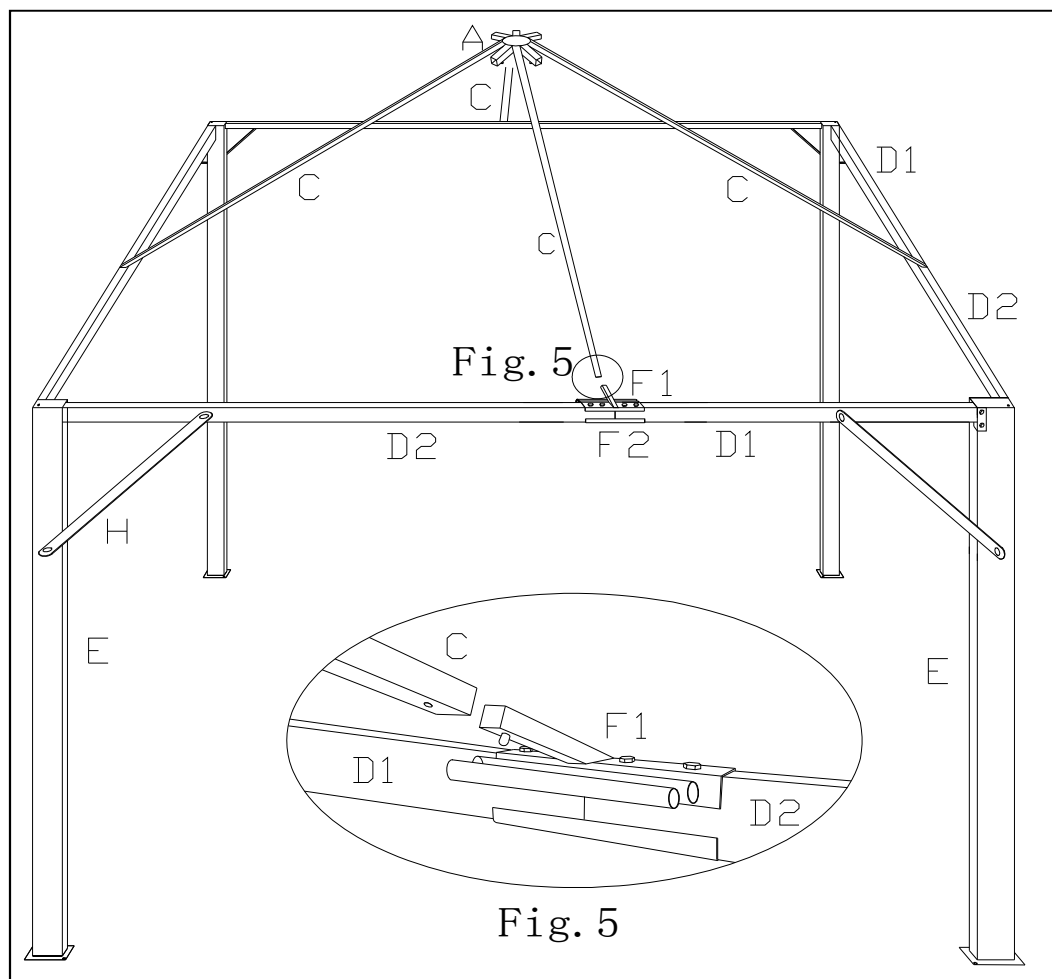
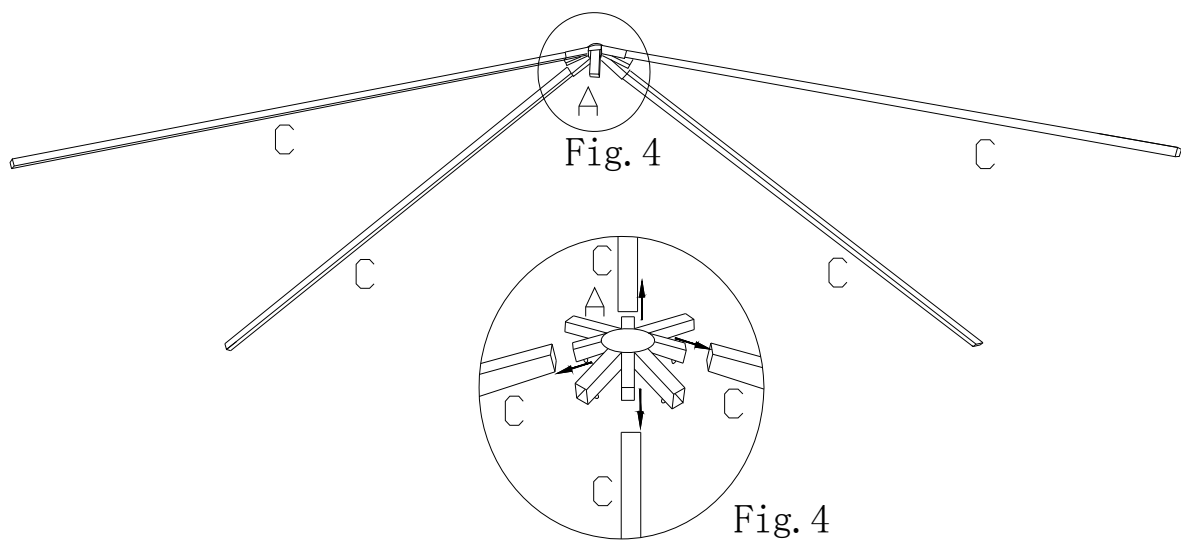

Attach each Short Top Bar(C) to Crown Center Connector(A) using the preattached snap buttons. (See Fig.4)

Have 4 adults lift the assembled Short Top Bar(C) onto the assembled Gazebo frame. Then, attach the other end of the Short Top Bar(C) to the T Shape Connector(F1) using the preattached snap buttons. (See Fig. 5)

DO NOT OVERTIGHTEN BOLTS at this step.

Step 3

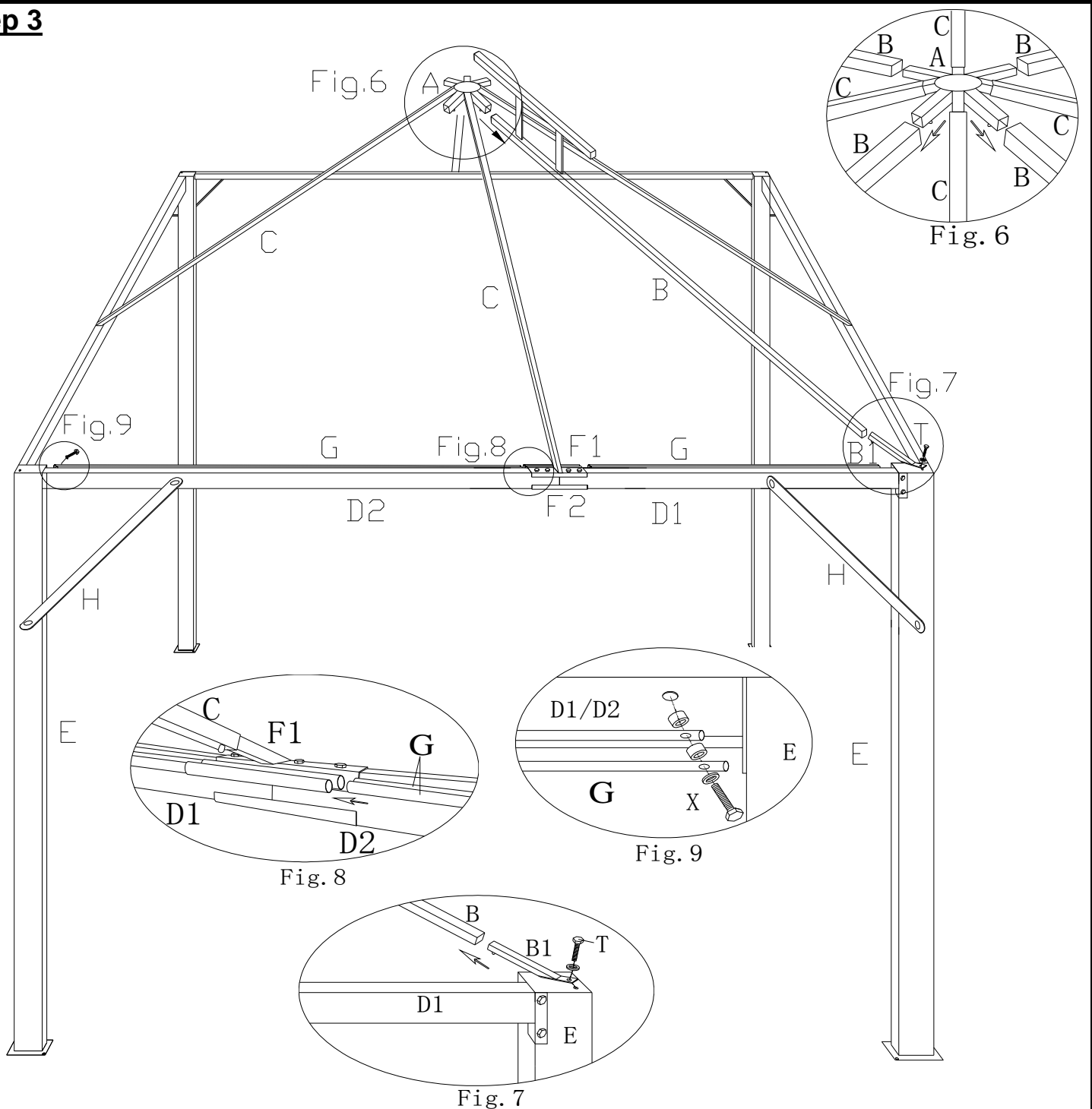

Attach the Long Top Bar(B) to the Center Connector(A) using the preattached snap buttons. (See Fig. 6)

Attach the other end of the Long Top Bar(B) to Connection Tube(B1) using the preattached snap buttons.

Attach the Connection Tube(B1) to the top of the Post(E) using Hardware(T) with Wrenches(Z). (See Fig.7)

Insert one side of the Sliding Rail (G) into the T Shape Connector(F1) (See Fig. 8).

Fix the other end of the Sliding Rail (G) to the Cross Bar(D1, D2) using Hardware(X) with Wrenches(Z).

Please add plastic Gasket (X) between each two tubes. (See Fig. 9)

Repeat this step to affix other 3 Long Top Bar(B) up.

NOW PROCEED TO FULLY AND SECURELY TIGHTEN UP ALL BOLTS at every Pillar and Master Beam and Crown and Corner Connector.

And Add Plastic Nut Caps on all nut ends to protect skin or clothing from getting snagged.

Step 4

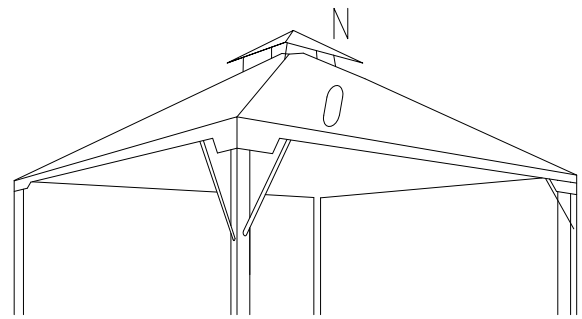
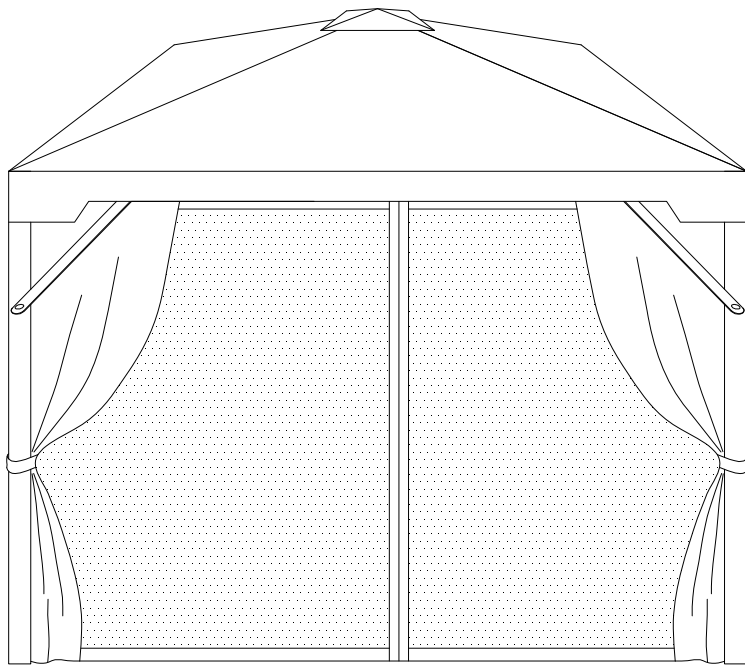

Fig. 10

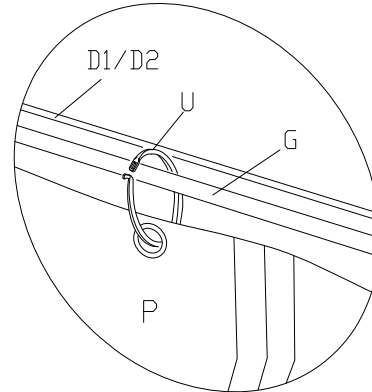

Fig.12

11

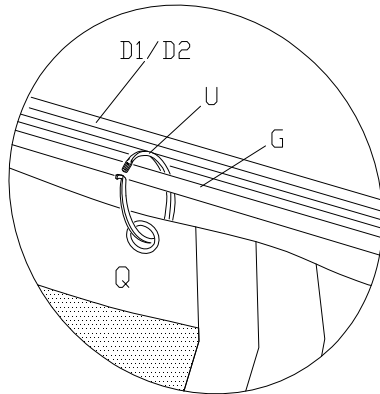

Fig.13

12

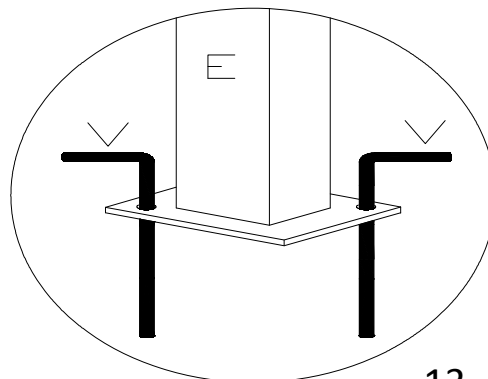

Fig.14

13

On the ground, curl and roll the Canopy and hoist onto the top of the gazebo frame.

Place the Canopy(O) onto the frame of the Gazebo.

At this stage, DO NOT UNFOLD and drape the Canopy.

DO NOT secure the Canopy at this stage.

Put the Vent Canopy (N) onto the frame, then securely attach the Canopy(O) to the Top Tube and the Cross Beams using the magic tape strips. (See Fig.10)

Now proceed to securely fasten the Canopy(O) into position.

Hang the Curtain(P) onto the outside Sliding Rail(G) with the Plastic Rings(U) (See Fig.11).

Hang the Mosquito Netting(Q) onto the inside Sliding Rail(G) with the Plastic Ring(U). (See Fig.12)



















Adjust the position of the Gazebo as desired.

Affix the Gazebo to the ground by inserting the Stake(V) through the Post(E) bases. (See Fig.13)

Your Gazebo is ready for use.

Additional Care: Water may collect and pool in areas of the Canopy after periods of heavy rain. To remove the water stand under the Canopy and gently push up on the underside of the Canopy, where the water is collecting, with a rounded stick or broom handle until the water spills away. **DO NOT USE** anything with a hard or pointed edge to perform this action as you may cause a puncture or tear in the Canopy.

Care & Maintenance

-   • Do not put hot items directly on furniture surface
 -   • Do not clean furniture with harsh cleansers or polish.
 -   • To obtain the longest lifespan of your outdoor products, minimizing exposure to direct sunlight is recommended.
 -   • Children should not climb or jump on the furniture.
 -   • Do not write on furniture without a padded barrier to protect the surface.
 -   • To obtain the longest lifespan of your outdoor products, avoid extended and lengthy exposure to rain, snow, and direct sunshine. Whenever possible cover the product and /or place under patio or awnings.
 -   • Not for commercial use. For residential use only .
 -   • Stains may be removed with mild soap solution and damp cloth.
-
-   • Dust and pick-up spills using a clean, non-colored, lint-free cloth .

What is Proposition 65?

Proposition 65 is a California law that requires warning labels on products that may contain one of more than 800-plus chemicals or ingredients that the California Office of Environmental Health Hazard Assessment (OEHHA) has deemed to cause cancer or other reproductive toxicity. Chemicals and elements on this list include wood dust, brass, and other everyday substances, which can be found in very common household items, such as: lamps, tableware, jewelry, crystal glasses, electric cords, beauty products, automobiles, and furniture.

Why Did I Find a Proposition 65 Warning on My Home Goods Product?

We include Proposition 65 warnings on all of our products because there is always a chance that one of the 800-plus common chemicals and ingredients listed under this law could potentially be on our furniture or packing materials. We risk large fines under this law, if we don't include this warning.

Should I worry?

We realize you may be worried finding this warning on our products, but we want to reassure you that the hazardous exposure limits for any of these chemicals have never been found on furniture products that we've shipped to our customers. Additionally, this warning label is very common and can be found on almost every piece of furniture sold in the state of California.

Just How Common Are Proposition 65 Warnings?

Proposition 65 warnings have become so common in California that it is hard to take a trip to a local bank, grocery store, or restaurant without finding at least one warning. In fact, even the Disney Land Resort has a Proposition 65 warning:

