



Assembly Instructions





Caution : You must read this before you proceed

Canopy Sunshade







Parts List

Label	Picture	Description	QTY
A		Base Support	1
B		Base Pole	1
C		Top Acrylic Base Pole	1

D		Bottom Acrylic Base Pole	1
E		Canopy Sunshade (Preattached with Curved Support Pole)	1
F		Canopy Sunshade Cap	1
G		Base Pole Cap	1

Hardware

Label	Picture	Description	QTY
①		Washer	5
②		Nut	5
③		Screw With Acrylic Cap	1
④		Wrench	1

Assembly Preparation

Before Beginning Assembly:

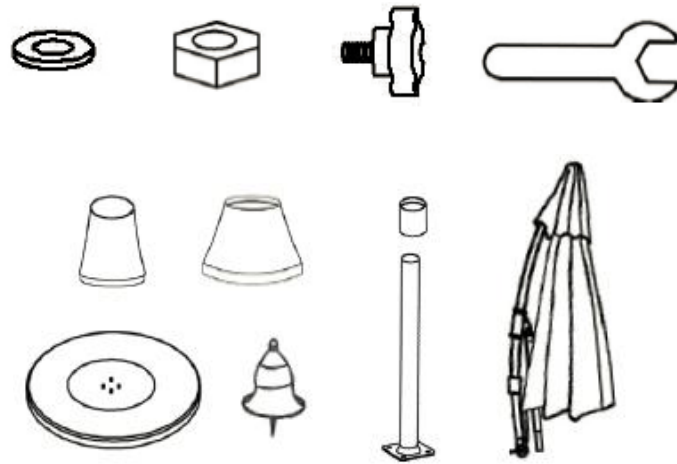

- Read instructions, cover to cover-



- Have 2 adults on hand for assembly-



- Do not assemble on flooring or carpet-



- Assemble on a clean non-marring surface (packing foam)-



- Save all packaging until finished-

Assembly Steps

Overview

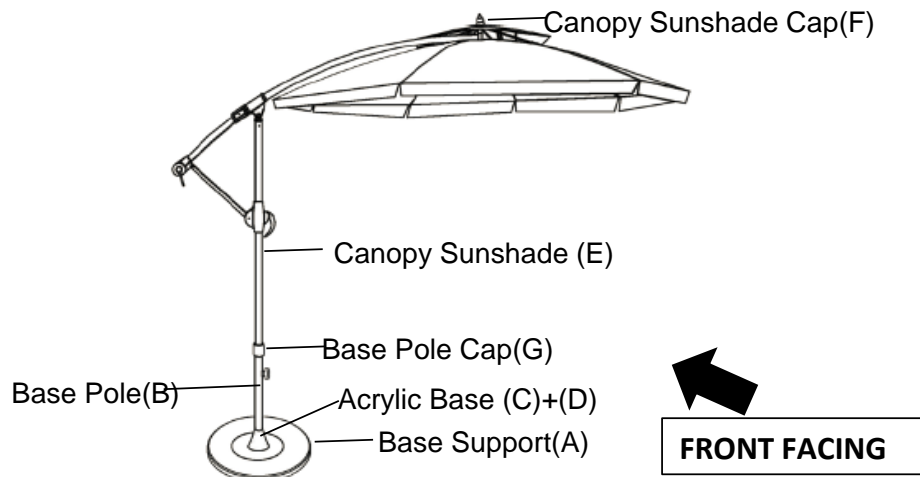

This Canopy Sunshade has multiple parts and may require up to some 30 minutes to assemble. To give you an overview of the Canopy Sunshade parts, the above picture is to help you put the various parts into perspective. Please read through the instructions below to familiarise yourself with the parts and steps before assembly.

Step 1

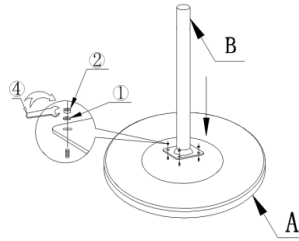

Align the mounting positions of the Base Pole(B) onto Base Support(A) and attach them with Washer(1) and Nut(2) using Wrench(4).

Caution: Some parts are heavy and awkward, take care of your safety and have an adult helper.

Step 2



Insert Top Acrylic Base Pole (C) onto Bottom Acrylic Base Pole(D) and join them together by pushing firmly downwards until they lock into position.

Step 3

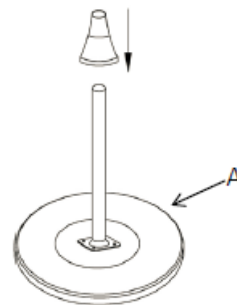

Place the Acrylic Base Pole on the Base Support(A).

Step 4

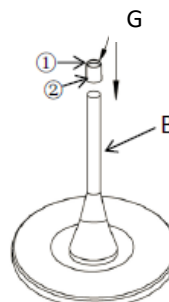

Insert Base Pole Cap(G) onto Base Pole(B).Ensure the label marked "Ⓞ" is at the bottom.Note: The Base Pole Cap(G) may require additional force to attach completely.If necessary please use a rubber mallet or wooden hammer to gently tap them into place.

Step 5

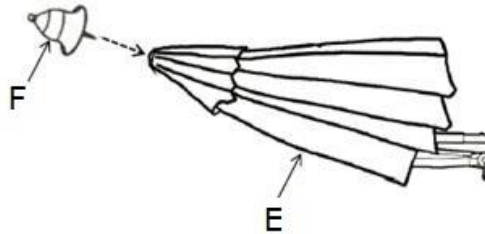

Screw on the Canopy Sunshade Cap(F) into the top of the Canopy Sunshade(E).

Step 6

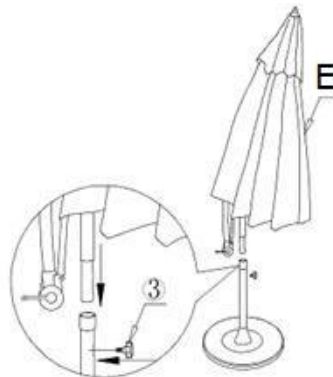

Insert the pole of the Canopy Sunshade(E) into the Base Pole(B) aligning them ounting positions of (E) and (B).Screw-in the Screw With Acrylic Cap(Ⓝ) by hand into the mounting positions of(E) and (B) to ensure that the pole is tightly secured to the base.Your Canopy Sunshade is fully assembled.

Caution: The Canopy Sunshade can only be used on a flat, level surface.

Operation Steps

Step 1

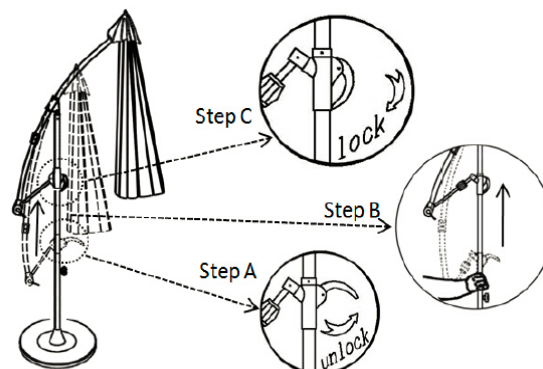

To use the Canopy Sunshade, you need to apply a 3 step process. These are : Step A - First push the lever of the Hand Grip upwards to unlock the Curved Support Pole. Step B - Then slide the Hand Grip upwards along the pole about one meter above the ground. Step C - To lock, pull down the lever of the Hand Grip to lock onto the Curved Support Pole into position.

Step 2



Open the Canopy Sunshade by rotating the Crank clockwise. To close, rotate the Crank counterclockwise.

Step 3





















To adjust the Canopy Sunshade angle, push the Curved Support Pole upwards or downwards until you reach the desired height.

Step 4



Your Canopy Sunshade is ready for use. Caution: Always close the Canopy Sunshade when not in use and never use the Canopy Sunshade during strong windy conditions.

Care & Maintenance

-   ● Do not put hot items directly on furniture surface
 -   ● Do not clean furniture with harsh cleansers or polish.
 -   ● To obtain the longest lifespan of your outdoor products, minimizing exposure to direct sunlight is recommended.
 -   ● Children should not climb or jump on the furniture.
 -   ● Do not write on furniture without a padded barrier to protect the surface.
 -   ● To obtain the longest lifespan of your outdoor products, avoid extended and lengthy exposure to rain, snow, and direct sunshine. Whenever possible cover the product and /or place under patio or awnings.
 -   ● Not for commercial use. For residential use only .
 -   ● Stains may be removed with mild soap solution and damp cloth.
-
-   ● Dust and pick-up spills using a clean, non-colored, lint-free cloth .