

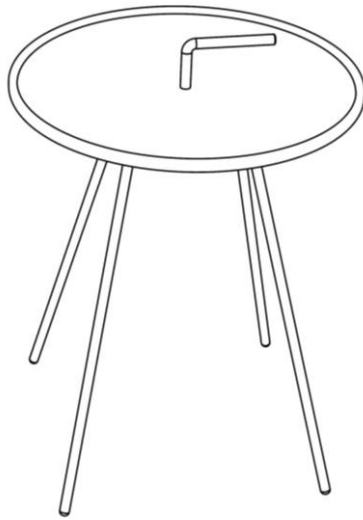



# Assembly Instructions

Caution: You must read this before you proceed.



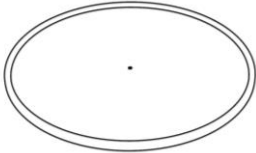

## Table



### Part List

Label	Picture	Description	QTY
A		Table Top	1
B		Handle	1
C		Plate	1
D		Legs	2

# Hardware

Label	Picture	Description	QTY
①		Bolt (M6X12MM)	6
②		Allen Key	1
③		Washer	6
④		Spring Washer	5

# Assembly Preparation

Before Beginning Assembly:

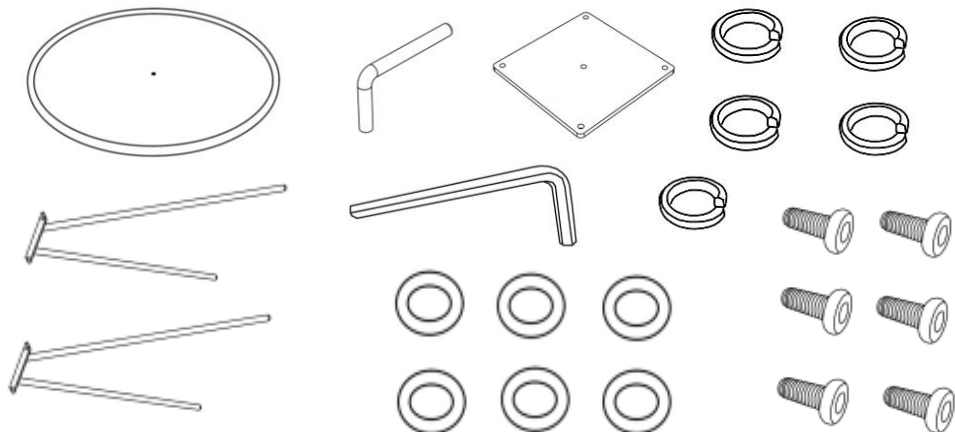

- Read instructions, cover to cover-



- Have 2 adults on hand for assembly-



- Do not assemble on flooring or carpet-



- Assemble on a clean non-marring surface (packing foam)-



- Save all packaging until finished-

# Assembly Steps

## Overview

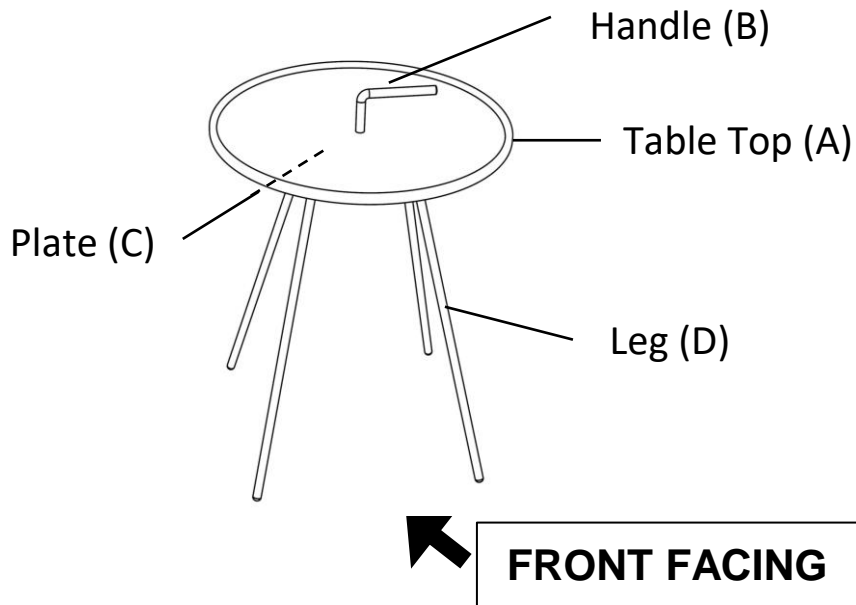

This Table has multiple parts and may require up to 30 minutes to assemble. To give you an overview of the Table parts, the above picture is to help you put the various parts into perspective. Please read through the instructions below to familiarise yourself with the parts and steps before assembly.

## Step 1

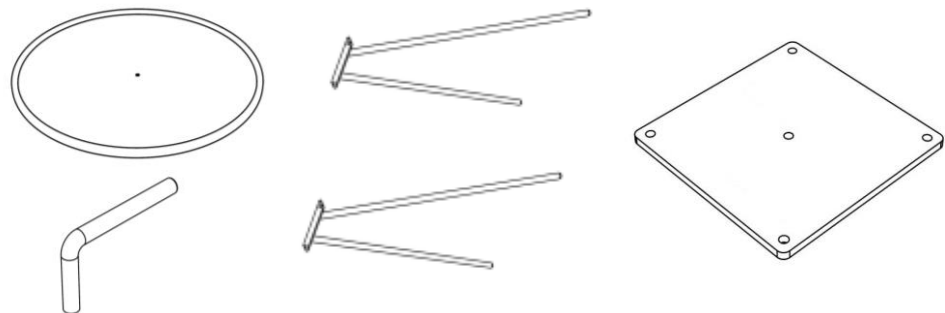

Remove all Parts from package, and place onto a clean, non-marring surface.

## Step 2

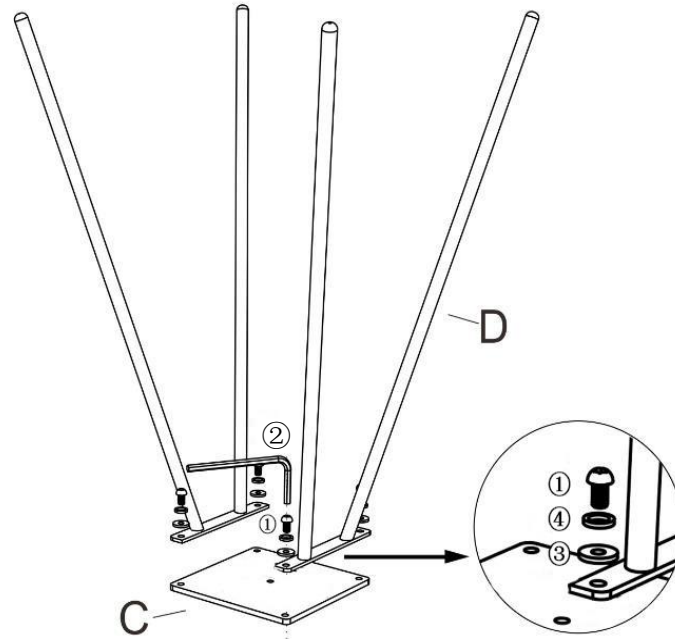

Align the mounting positions on the Plate(C) and the Leg(D).  
Attach Legs(D) to Plate(C) using Bolts(①), Spring Washers(④) and Washers(③) with Allen Key(②) as shown.  
**In a sequential manner, fully tighten all Bolts at all joints.**

## Step 3

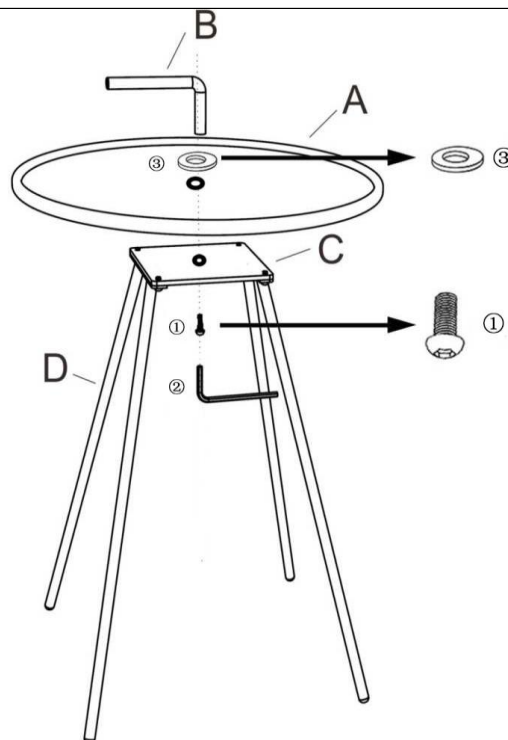

Stand the Legs with Plate up.  
Align the mounting positions on Handle(B), Table Top(A), and Plate(C).  
Attach Handle(B) to Table Top(A) and Plate(C) using Bolt(①) and Washer(③) with Allen Key(②) as shown above.



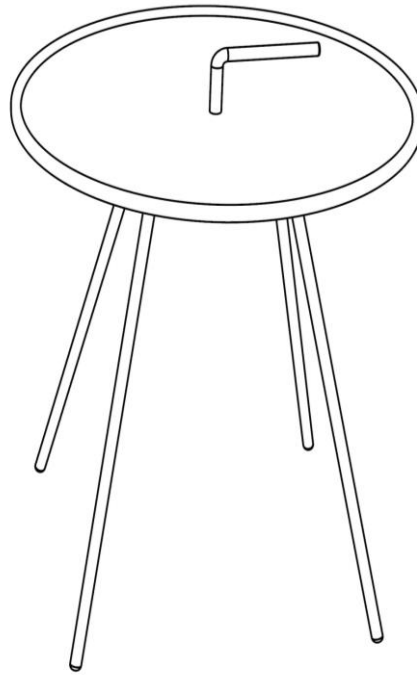















## Step 4



Your Table is now ready for use.

**This Table can only be used on a flat, level surface.**

## Care & Maintenance

-   ● Do not put hot items directly on furniture surface
  -   ● Do not clean furniture with harsh cleansers or polish.
  -   ● To obtain the longest lifespan of your outdoor products, minimizing exposure to direct sunlight is recommended.
  -   ● Children should not climb or jump on the furniture.
  -   ● Do not write on furniture without a padded barrier to protect the surface.
  -   ● To obtain the longest lifespan of your outdoor products, avoid extended and lengthy exposure to rain, snow, and direct sunshine. Whenever possible cover the product and /or place under patio or awnings.
  -   ● Not for commercial use. For residential use only .
  -   ● Stains may be removed with mild soap solution and damp cloth.
- 
-   ● Dust and pick-up spills using a clean, non-colored, lint-free cloth .