

# Assembly Instructions

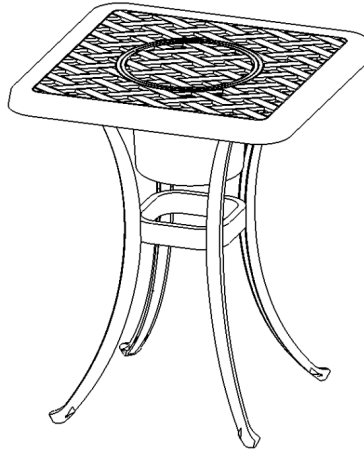



**Caution: You must read this before you proceed**

## Table









**CAUTION :** This table is NOT a TOY.  
Keep your child / children at bay in the process of assembly.

### Parts list

Label	Picture	Description	QTY
A		Table Top	1
B		Table Leg with Pre-attached Leveller	4
C		Central Square Support Ring	1
D		Cover	1
E		Ice Bucket	1

## Hardware

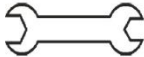
Label	Picture	Description	QTY
①		Stud(M8*40mm)	5
②		Washer(8mm)	9
③		Spring Washer(8mm)	9
④		Nut(8mm)	9
⑤		Nuts Cap( 8mm )	5
⑥		Screwdriver	1
⑦		Spanner	1

## Assembly Preparation

Before Beginning Assembly:

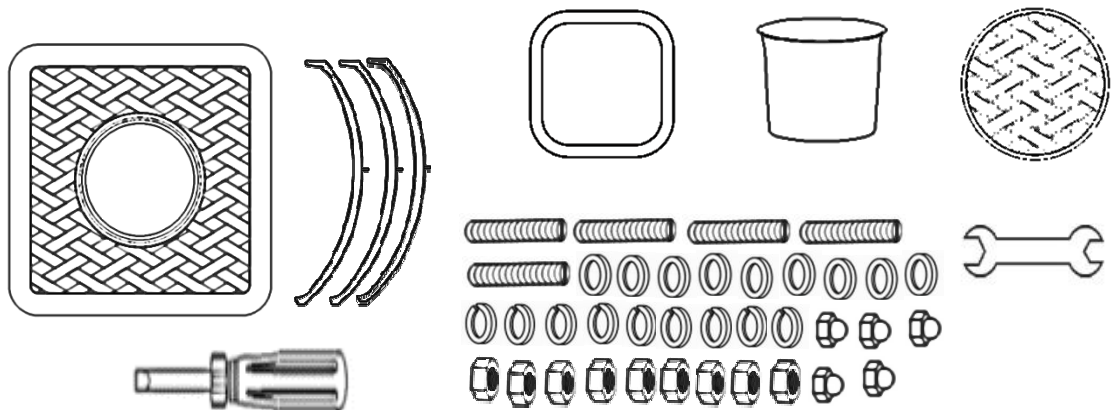

- Read instructions, cover to cover-



- Have 2 adults on hand for assembly-



- Do not assemble on flooring or carpet-



- Assemble on a clean non-marring surface (packing foam)-



- Save all packaging until finished-

## Assembly Step

### Overview

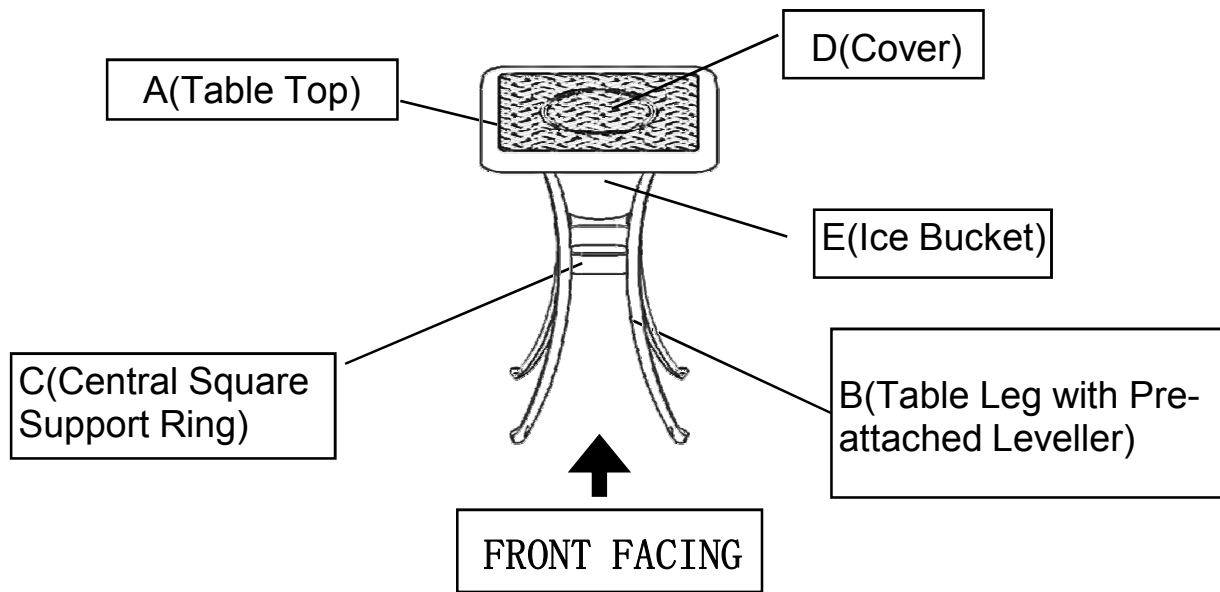

This table has multiple parts and may require up to 30 minutes to assemble.

To give you an overview of the table parts, the above picture is to help you put the various parts into perspective.

Please read through the instructions below to familiarise yourself with the parts and steps before assembly.

### Step 1

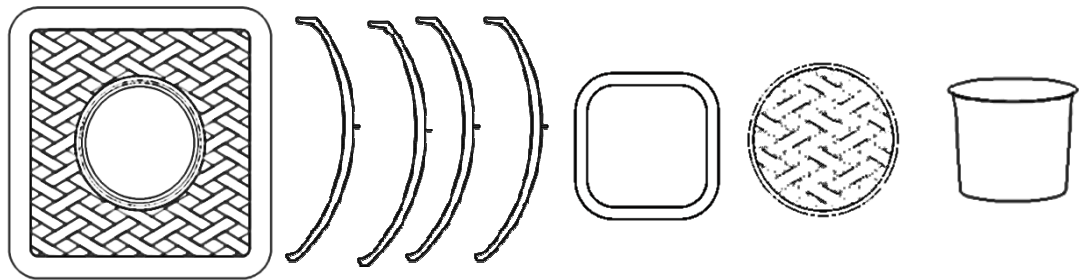

Unpack and place all parts on a clean soft surface.

## Step 2

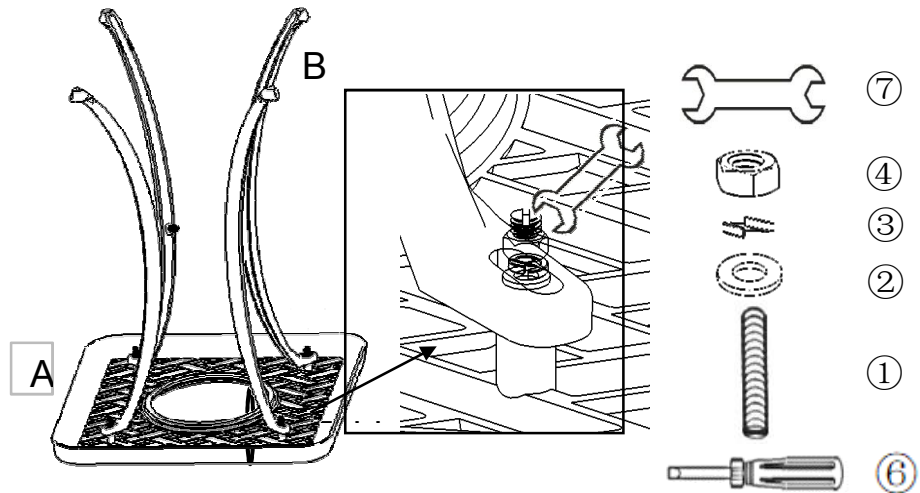

Turn the Table Top upside down on to a soft surface that does not scratch the table top.

Attach four Table Legs(B) to the contact points on the Table Top(A) with Bolts(①), Spring Washers(③) , Washers(②) and Nuts(④) using Screwdriver(⑥) and Spanner(⑦).

**DO NOT OVER TIGHTEN all Bolts.**

## Step 3

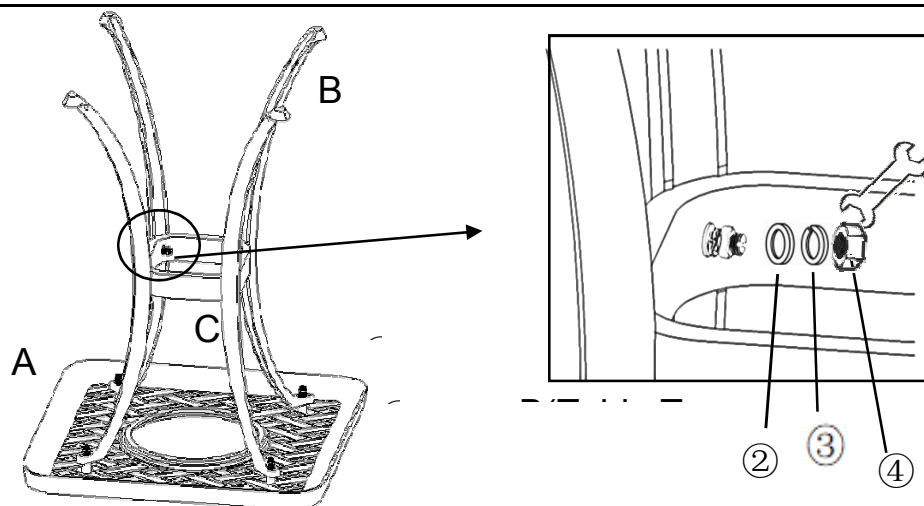

Attach the Central Square Support Ring(C) to Table Leg(B) using Washers(②), Spring Washers(③) and Nuts(④) with the Spanner(⑦). Repeat the same tightening at all 4 points of the Legs.

**DO NOT OVER TIGHTEN, yet.**

## Step 4

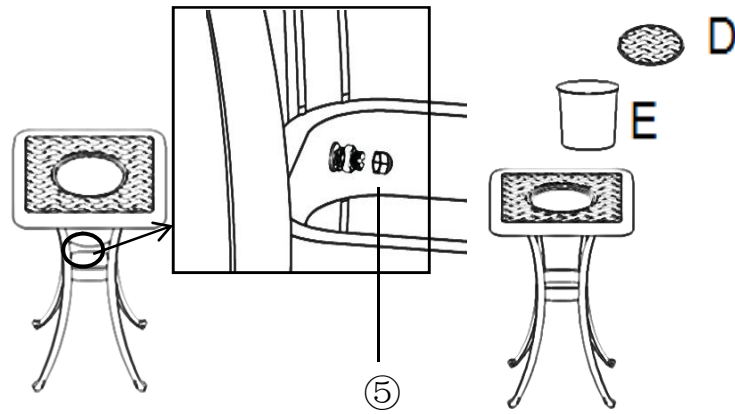

Turn the Table rightside up.

Then, proceed to tighten all Bolts and Nuts.

Add Nuts Cap(⑤) to the Nut(④).

Put the Ice Bucket(E) into the middle housing of the Table top(A).

Then put the Cover(D) over the Ice Bucket (E) .



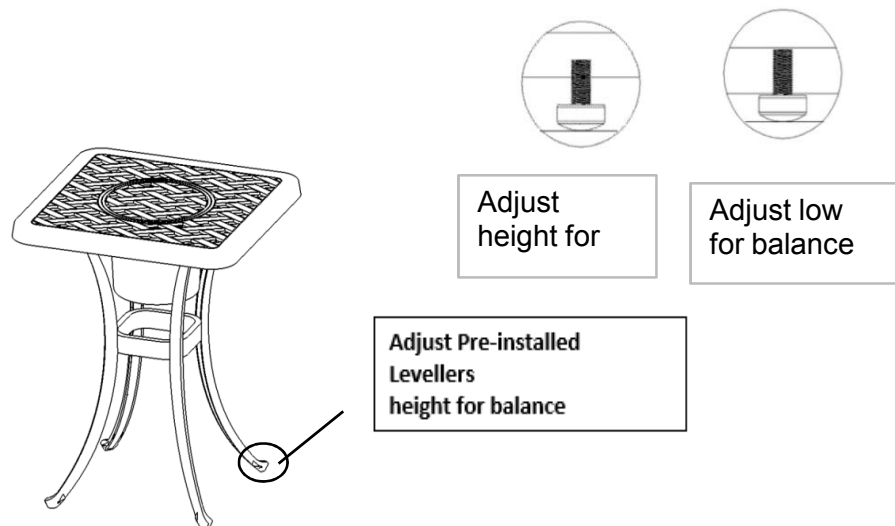





## Step 5



When necessary adjust the Pre-installed Levellers at the end of each Table Leg until the Table is level with the ground.

Your Table is now ready for use.

## Care & Maintenance

- ⊘  • Do not put hot items directly on furniture surface.
  - ⊘  • Do not clean furniture with harsh cleansers or polish.
  - ✓  • To obtain the longest lifespan of your outdoor products, minimizing exposure to direct sunlight is recommended.
  - ⊘  • Children should not climb or jump on the furniture.
  - ⊘  • Do not write on furniture without a padded barrier to protect the surface.
  - ✓  • To obtain the longest lifespan of your outdoor products, avoid extended and lengthy exposure to rain, snow, and direct sunshine. Whenever possible cover the product and /or place under patio or awnings.
  - ⊘  • Not for commercial use. For residential use only .
  - ⊘  • Stains may be removed with mild soap solution and damp cloth.
- 
- ✓  • Dust and pick-up spills using a clean, non-colored, lint-free cloth .