

Assembly Instructions

Caution : You must read this before you proceed

CHAIR

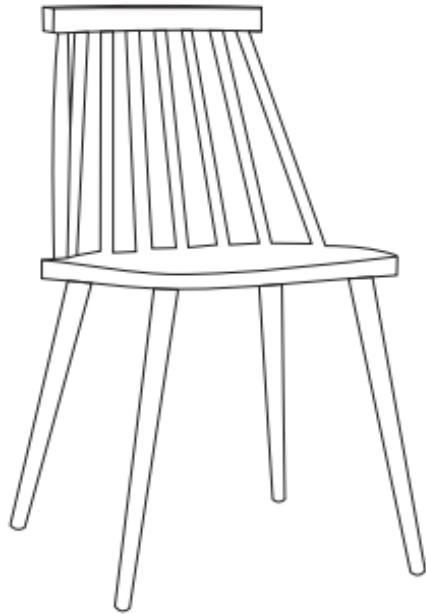





Parts List

Label	Picture	Description	QTY
A	A line drawing of the chair seat, showing a rectangular piece with rounded corners and a slightly raised edge.	Chair Seat	1

B		Leg Frame	1
---	--	-----------	---

Hardware

Label	Picture	Description	QTY
①		Bolt (M6*20mm)	5
②		Flat washer(16mm)	5
③		Allen Wrench(M5)	1
④		Spring Washer (10mm)	5

Assembly Preparation

Before Beginning Assembly:

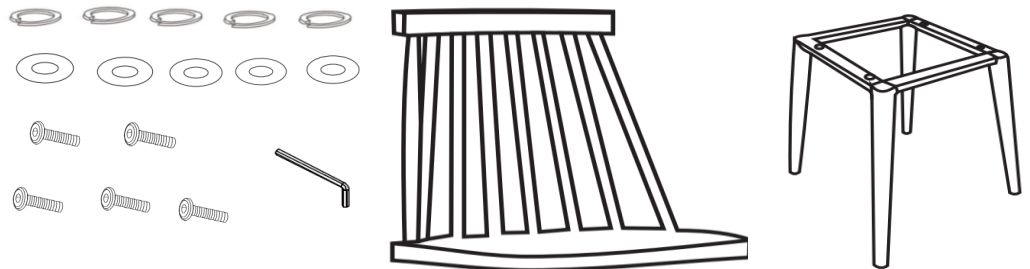

- Read instructions, cover to cover-



- Have 2 adults on hand for assembly-



- Do not assemble on flooring or carpet-



- Assemble on a clean non-marring surface (packing foam)-



- Save all packaging until finished-

Assembly Steps

Parts Introduction

Chair Seat (A)

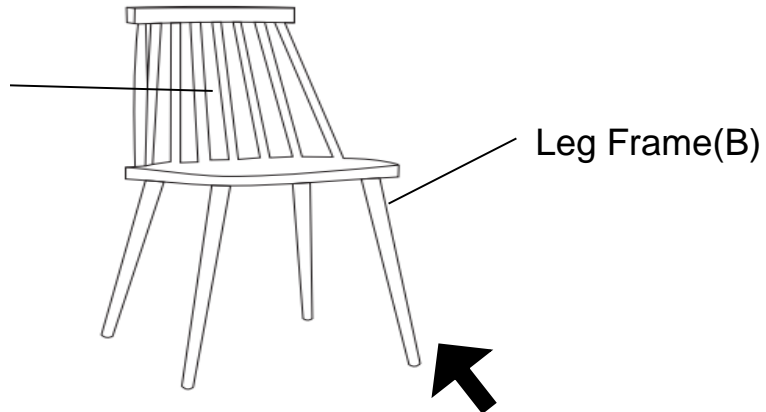

FRONT FACING

This Chair has multiple parts and may require up to some 30 minutes to assemble. To give you an overview of the Chair parts, the above picture is to help you put the various parts into perspective. Please read through the instructions herebelow to familiarise the parts and steps before assembly.

Step 1

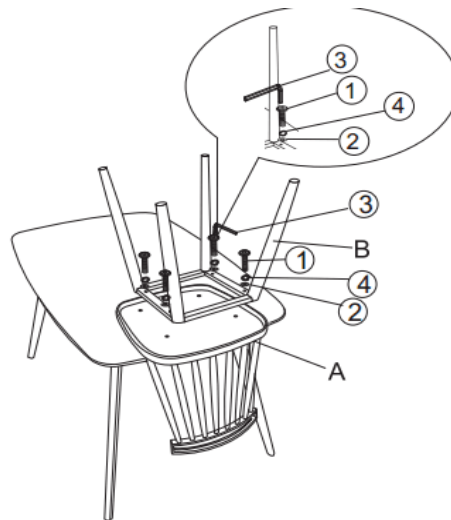

Place the Chair Seat(A) face down as picture on a clean, non-marring table .
With assistance from second adult,attach Leg Frame(B) to Chair Seat(A) using Bolts(①), Flat Washers(②) and Spring Washer (④) with Allen Key(③).

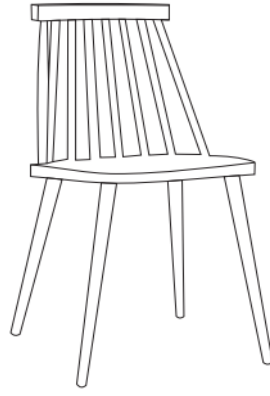

Stand the Chair up and place on flat, level surface.

Carefully and gently sit onto the Chair.

This will help properly align all parts at all joints and remove any gaps.

Carefully get off the Chair and gently turn it over.

Tighen all Bolts at all joints.

When tightening the Bolts, tighten sequentially.

Do not tighten any Bolt fully and then move on towards the next one, this would cause the frame to warp.

If the Chair is not Stable it could lead to damage to the product.

Your Office Chair is ready for use.

This Office Chair can only be used on a flat, level surface.

Care & Maintenance



- Furniture may scratch floors. We recommend using furniture pads to protect your floors.



- Do not put hot items directly on furniture surface.



- Do not clean furniture with harsh cleansers or polish.



- Do not place furniture under direct sunlight.



- Do not place furniture near heating or cooling vents.



- Do not write on furniture without a padded barrier to protect the surface.



- Do not place furniture outside . For indoor use only.



- Not for commercial use. For residential use only.



- Stains may be removed with mild soap solution and damp cloth.



- Children should not climb or jump on the furniture.



- Dust and pick-up spills using a clean, non-colored, lint-free cloth.