

Assembly Instructions

Caution : You must read this before you proceed

ARTIFICIAL CHRISTMAS TREE

CAUTION : IMPORTANT SAFETY INSTRUCTIONS

- The product is for indoor only
- This seasonal use product is not intended for permanent installation or use.
- When decorating trees, use miniature light bulb strings or LED light strings only. "C" size bulbs are not recommended.
- Do not mount or place near gas or electric heaters, fireplaces, candles or other similar sources of heat.
- Do not secure the wiring of the product with staples or nails, or place on sharp hooks or nails.
- Unplug the product when leaving the house, when retiring for the night, or if left unattended.
- CAUTION:** This is an electrical product-not a toy! To avoid risk of fire, burns, personal injury and electric shock, it should not be played with or placed where small children can reach it.
- Do not let lamps rest on the supply cord or any wire.
- Do not use this product for other than its intended use.
- Do not hang ornaments or other objects from cord, wire or light string.
- Do not close doors or windows on the product or extension cords as this may damage the wire insulation.
- Never operate this product if the power cord or plug is damaged.
- Use only manufacturer specified replacement bulbs.
- Read and follow all instructions that are on the product or provided with the product.
- USE AND CARE INSTRUCTIONS**
- When storing the product, carefully remove the product from wherever it is placed, including trees, branches, or bushes, to avoid any undue strain or stress on the product conductors, connections, and wires.
- When not in use, store neatly in a cool, dry location protected from sunlight.

Part List

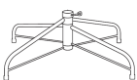
Label	Picture	Description	QTY
A		Top Tree Section (larger Trees include one or more Sections)	1
B		Metal Tree Stand	1

Assembly Steps

Step 1

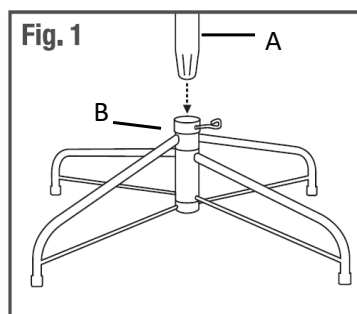

Each carton contains one Top Tree Section (A) or one Bottom Tree Section (larger trees include one or more Middle Sections) and a Metal Tree Stand (B).

Unfold a Metal Stand (B) and insert the Eye Bolt. Remove packing material from ends of Poles. Put Bottom Section Pole into Tree stand making sure it is seated properly (Figure 1). Tighten Eye Bolt.

WARNING: Using excessive force to assemble base may cause breakage.

Step 2

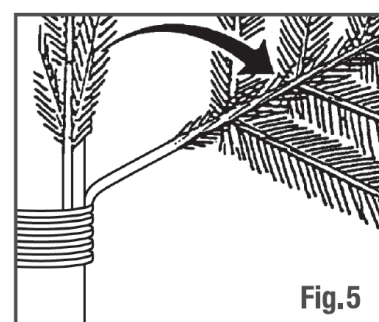
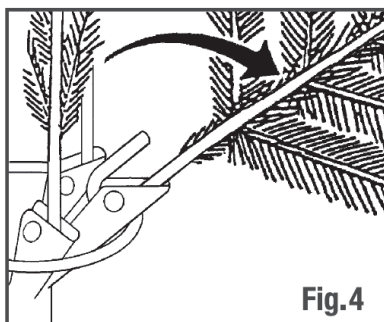

Insert the Top Tree Section into the Green Plastic opening of the lower Tree assembly. This is the "Pole Cap" which keeps Tree top section securely in place (Figure 3). For larger Trees with middle section carefully insert middle section pole(s) into bottom section pole (Figure 4) as instructed in SPECIAL NOTE ABOUT GLANT TREES below.

Then insert Top Section into Pole Cap.

Optional: You may want to lubricate Middle Section Pole ends prior to assembly. This will make Sections easier to separate when disassembling for storage.

HINGED TREES: Branches should fall into place during assembly. If any branches remain upright, gently lower them into proper position (Figure 5). Each Branch must be shaped to a natural position by spreading out the left and right tips away from the center tip. Continue to lower branches on upper section(s) in the same manner making sure not to place undue pressure on the brackets.

Shaping Instructions

Shaping the Tree Branches is the last step of assembly. The care and attention given to this final process will result in a genuinely beautiful and appealing holiday centerpiece.

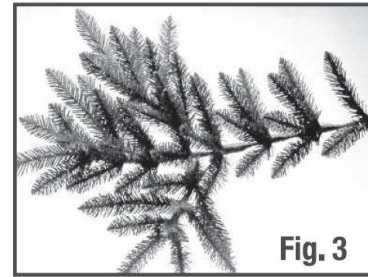
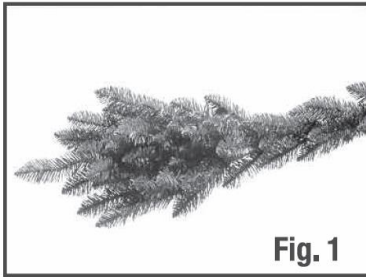

1. Every tree style is shipped from the factory with the tips of each Branch compressed to the center(Figure 1).
- 2.Each Branch tip must be shaped to it's proper position to give the tree a natural look. This is done by gently grasping the left and right wing tips and spreading them out away from the center tip(Figure 2).
- 3.Each individual tip should then be spread out separately. Tips should then be bent slightly upward to add a more natural looking appearance. Figure 3 shows a typical tree Branch after shaping.
- 4.As you shape closer to the top, the Branches will not have wing tips, but will otherwise shape in the same manner as lower sections.

Pre-Lit Hinged Trees

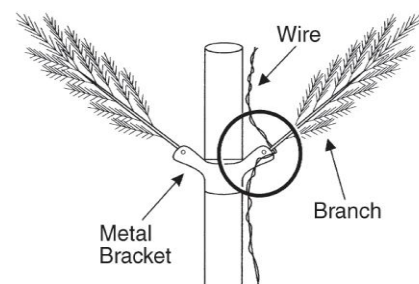
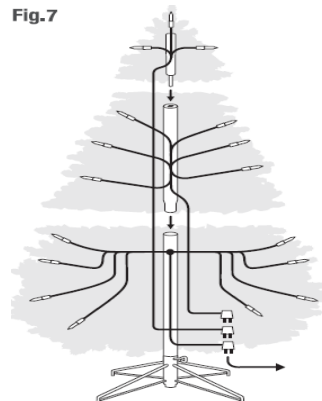
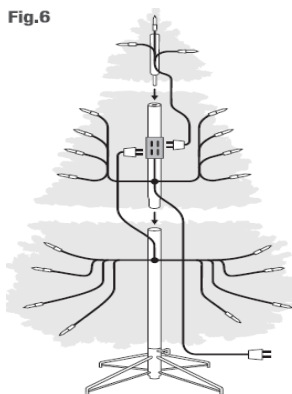

Style 1: Some tree styles will have a single extension cord that will run from the center part of tree and out to the electrical outlet ALL lights strings will plug into this single cord(Figure 6).

Style 2: The light string cords from all sections should be pulled down through the center of the tree, The cords can then be plugged into each other and then into an extension cord to power supply(Figure7).

IMPORTANT NOTE: When lowering branches be extremely careful not to tangle wire in gap between branch and metal bracket.

Storage

Remove all holiday decorations. Gently press tips back into center Branch. Raise all Branches to original upright position taking care not to place undue pressure on the attached ends of the branches. When disassembling tree, a twisting motion will help to separate the sections from each other. All tree parts can be replaced in carton and should be stored in a cool, dry place.

Bulb Replacement Instructions

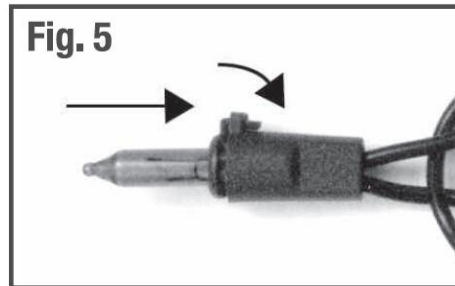
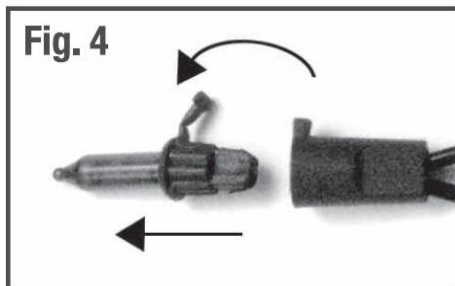

1. Unplug light string from power source.
2. Pull up on the Bulb Lock unlatching the bulb from the bulb socket. Gently pull the bulb straight out (Figure 4).
3. Before inserting the new bulb into socket, make sure that the two wires on either side of the bulb base are straight up and flush with the base (diagram at right).

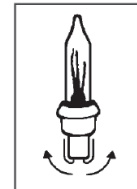

4. Carefully insert new bulb into socket and push down Base Lock TM until it snaps into place (Figure 5).

Fuse Replacement Instructions

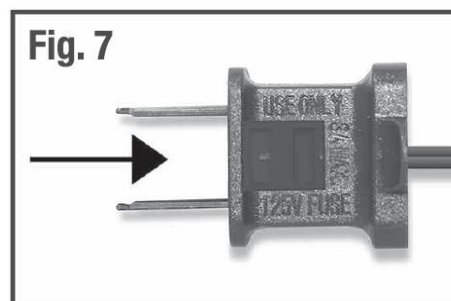
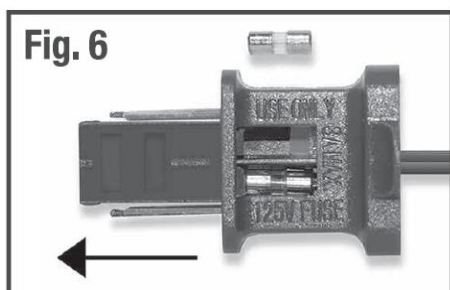

1. Unplug light string from power source.
2. Fuses are located in light string plug. Slide the fuse access cover away from cord side (in direction of arrow, Figure 6) exposing fuses.
3. Remove fuses from compartment and examine, Replace burnt out fuse with new one.
4. Close fuse compartment by sliding access cover back in towards cord side of plug (Figure 7).

Care & Maintenance

- Wipe the branches clean with a soft cloth.
- If it is extra dirty or dull, use warm water and a few drops of dishwashing soap in a spray bottle.
- Spray stained areas of the tree and wipe with a soft cloth.
- Allow either kind of tree to dry thoroughly before decorating.
- Pack individual sections of the tree in plastic bags or old bedsheets to protect them from accumulating more dust and dirt in storage.
- Exposure to heat or humidity may cause its material to warp from its original shape.