

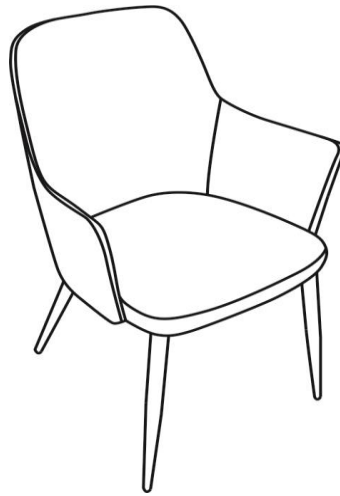



Assembly Instructions

Caution : You must read this before you proceed

Dining Chair





Parts List

Label	Picture	Description	QTY
C		Chair Body	1
B		Front Leg	2
A		Back Leg	2

Hardware

Label	Picture	Description	QTY
①		Bolt (M6 x 16mm)	13

②		Washer	13
③		Spring Washer	13
④		Allen Wrench	1

Assembly Preparation

Before Beginning Assembly:

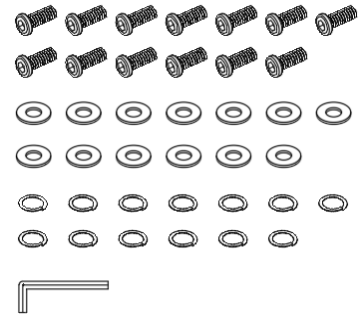
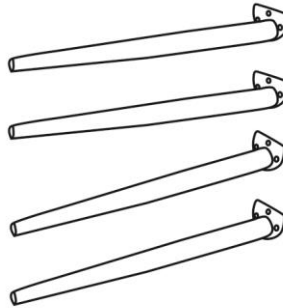
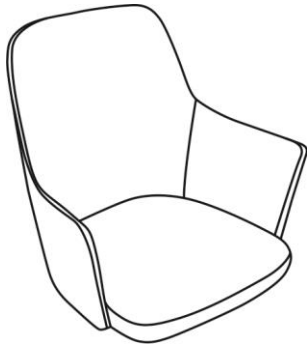

- Read instructions, cover to cover-



- Have 2 adults on hand for assembly-



- Do not assemble on flooring or carpet-



- Assemble on a clean non-marring surface (packing foam)-



- Save all packaging until finished-

Assembly Steps

Overview

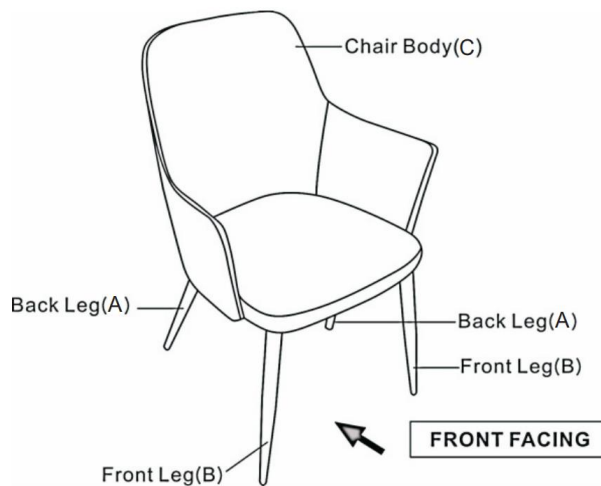

This Dining Chair has multiple parts and may require up to 30 minutes to assemble. To give you an overview of the Dining Chair parts, the above picture is to help you put the various parts into perspective. Please read through the instructions below to familiarise yourself with the parts and steps before assembly.

Step 1

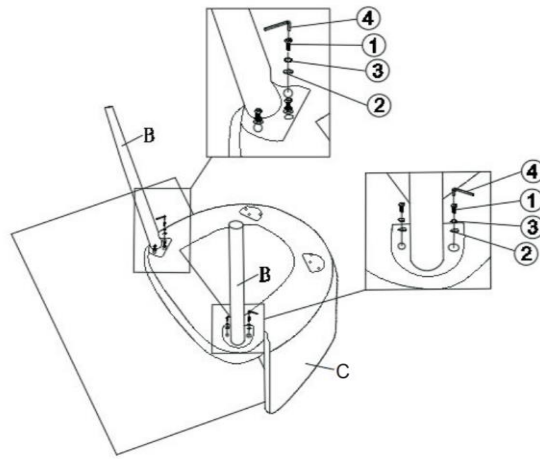

Place the Chair Body(C) face down on the edge of a clean, non-marring Table Top.

Attach the Front Legs(B) to the Chair Body(C) using the Bolts(①), washers(②) and spring washers(③), with the Allen Wrench(④) as pictured above.

Do not fully tighten the Bolts.

Step 2

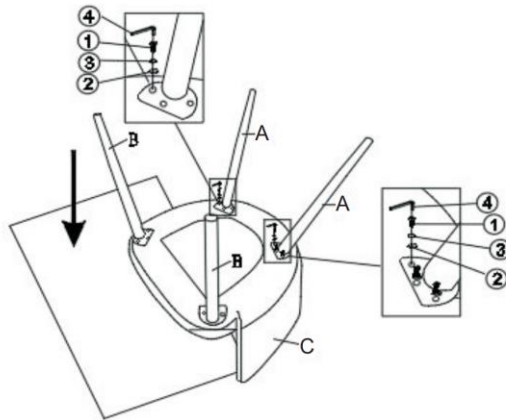

Attach the Back Legs(A) to the Chair Body(C) using the Bolts(①), washers(②) and spring washers(③), with the Allen Wrench(④) as pictured above.

Do not fully tighten the Bolts.

Step 3

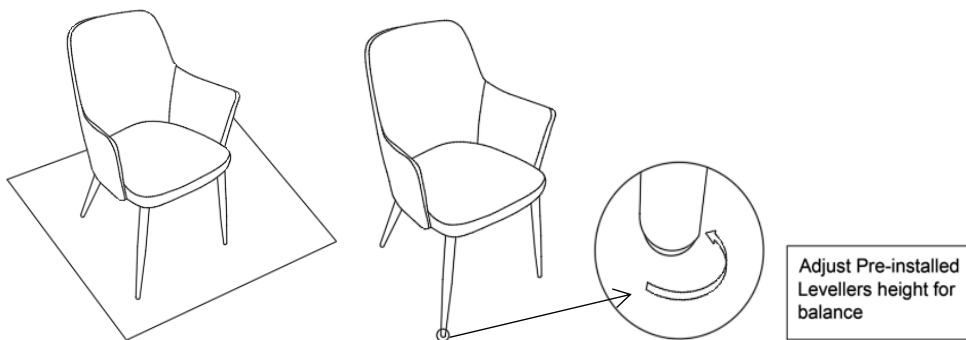

Stand the Chair up and place on a flat, level surface.
Carefully and gently sit onto the Chair.
This will help to properly align all parts at all joints and remove any gaps.
Carefully get off the Chair and gently turn it over.
Tighten all Bolts at all joints.
When tightening the Bolts, tighten sequentially.
Do not tighten any Bolt fully and then move on towards the next one, this could cause the frame to warp.
If the Chair is not Stable it could lead to damage of the product.

Step 4

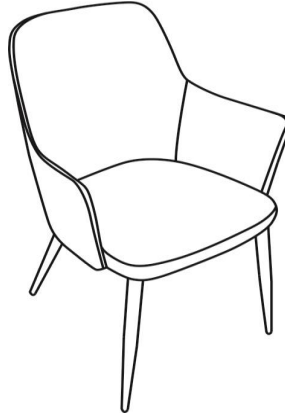

Your Dining Chair is ready for use.
Caution: This Dining Chair can only be used on a flat, level surface.

Care & Maintenance



- Furniture may scratch floors. We recommend using furniture pads to protect your floors.



- Do not put hot items directly on furniture surface.



- Do not clean furniture with harsh cleansers or polish.



- Do not place furniture under direct sunlight.



- Do not place furniture near heating or cooling vents.



- Do not write on furniture without a padded barrier to protect the surface.



- Do not place furniture outside . For indoor use only.



- Not for commercial use. For residential use only.



- Stains may be removed with mild soap solution and damp cloth.



- Children should not climb or jump on the furniture.



- Dust and pick-up spills using a clean, non-colored, lint-free cloth.