

# Assembly Instructions

**Caution : You must read this before you proceed.**

## Swivel Barstool

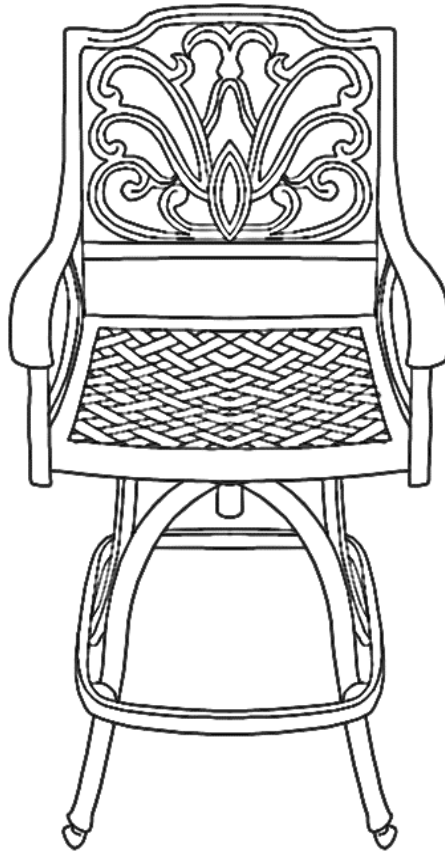

**Caution : This barstool is NOT a TOY.  
Keep your child / children at bay in the process of assembly.**

### Parts List

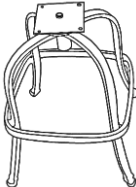
Lable	Picture	Description	Qty
A		Chair Seat	1
B		Chair Leg Base	1

## Hardware

Label	Picture	Description	Qty
①		Bolt(M8*40mm )	5
②		Washer( 8mm )	5
③		Springs Washer( 8mm)	5
④		Spanner	2
⑤		Nut(8mm)	5

## Assembly Preparation

Before Beginning Assembly:

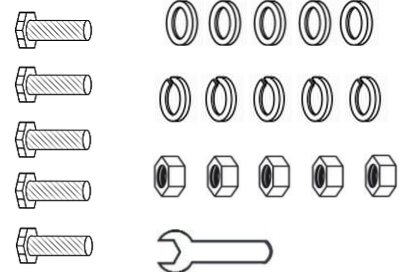
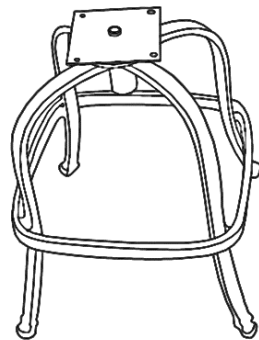
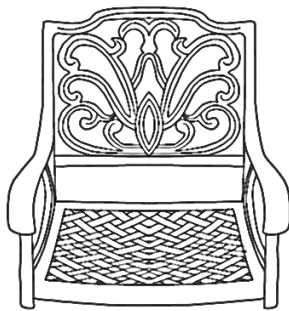

- Read instructions, cover to cover-



- Have 2 adults on hand for assembly-



- Do not assemble on flooring or carpet-



- Assemble on a clean non-marring surface (packing foam)-



- Save all packaging until finished-

## Assembly Steps

### Overview

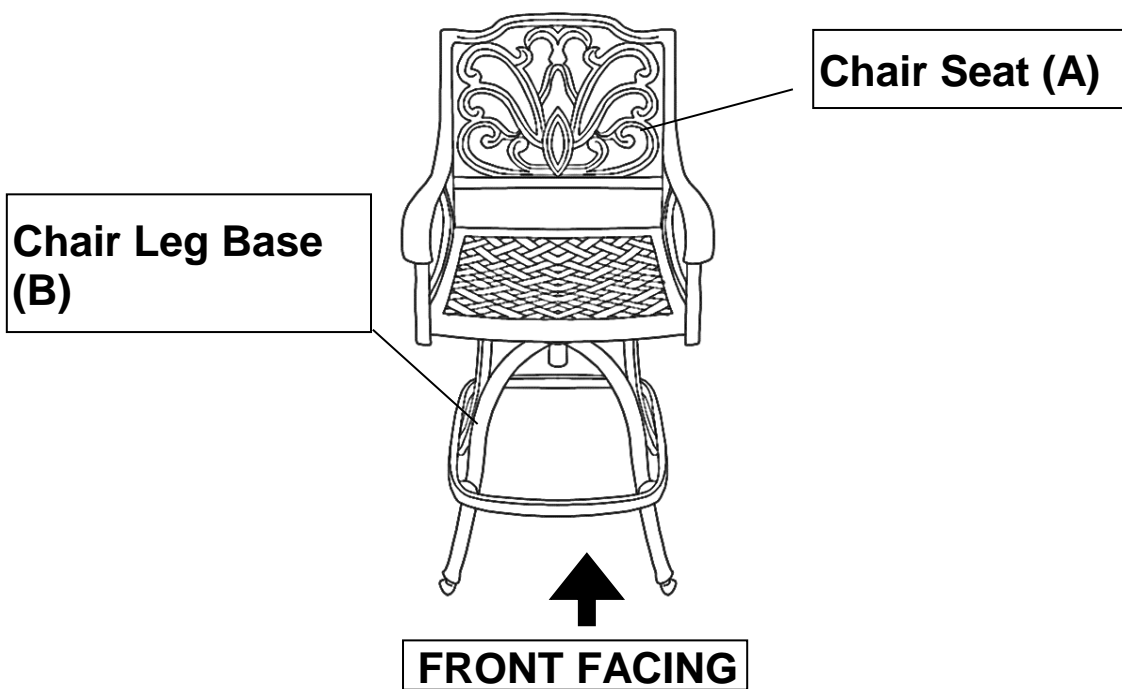

This Barstool has multiple parts and may require up to 30 minutes to assemble.

To give you an overview of the Barstool parts, the above picture is to help you put the various parts into perspective.

Please read through the instructions below to familiarise yourself with the parts and steps before assembly.

### Step 1

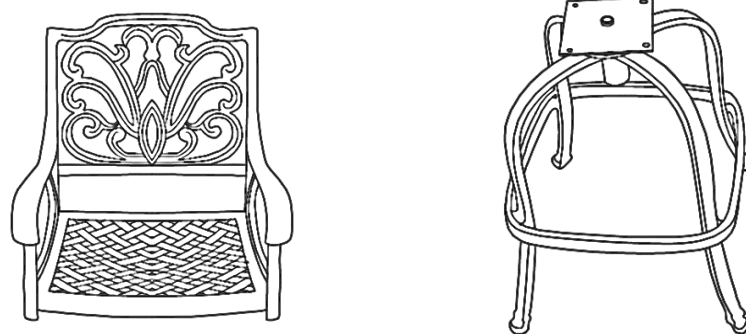

Unpack and place all parts on a clean soft surface.

## Step 2

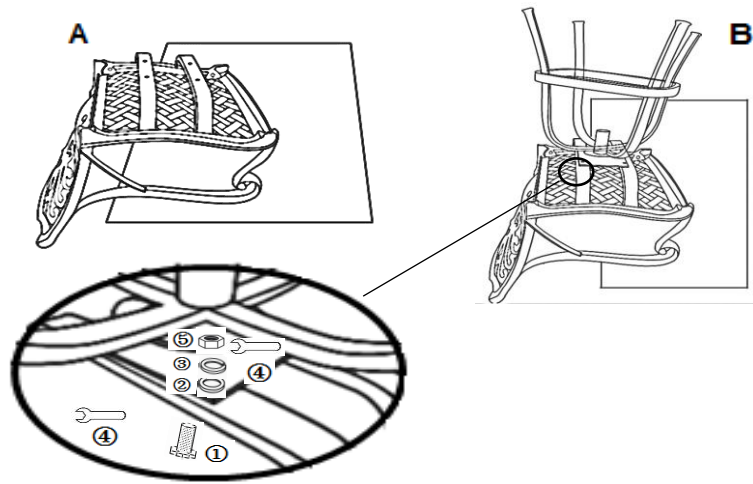





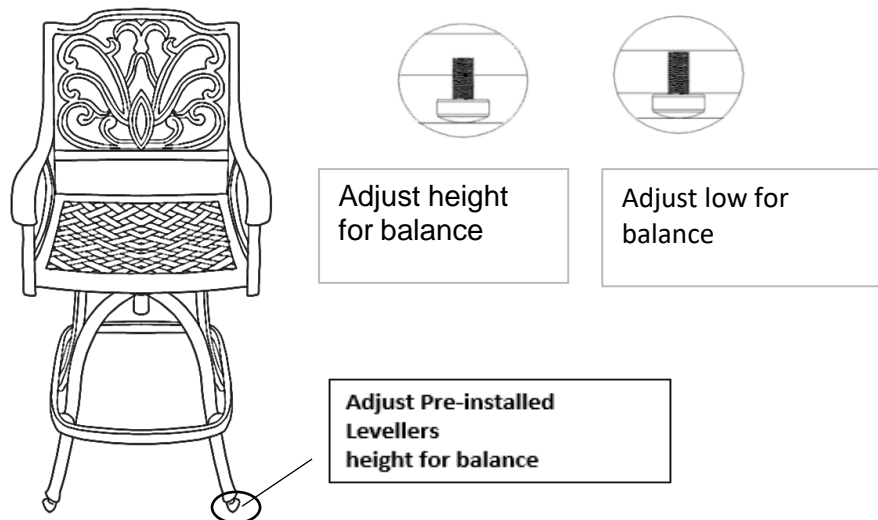



Place Chair Seat(A) upside down.  
Align the mountings on the bottom of the Chair Seat(A) with the mountings on the Chair Leg Base(B).  
Then, attach the Chair Leg Base(B) to the Chair Seat(A) with Bolts(①), Washers(②) and Springs Washers(③) using the Spanner(④).  
Do this in a sequential manner.  
**Do not over tighten yet.**

## Step 3



Make sure that the Chair Seat and the Chair Leg Base is fully and firmly attached together as one complete piece.  
Turn Barstool rightside up.  
Adjust the pre-installed Leveller until the Barstool is level with the ground.  
Then, proceed to tighten all Bolts and Nuts.  
**Your Barstool is ready for use.**  
**Caution: This Barstool can only be used on a flat, level surface**

## Care & Maintenance

-  Do not put hot items directly on furniture surface.
  -  Do not clean furniture with harsh cleansers or polish.
  -  To obtain the longest lifespan of your outdoor products, minimizing exposure to direct sunlight is recommended.
  -  Children should not climb or jump on the furniture.
  -  Do not write on furniture without a padded barrier to protect the surface.
  -  To obtain the longest lifespan of your outdoor products, avoid extended and lengthy exposure to rain, snow, and direct sunshine. Whenever possible cover the product and /or place under patio or awnings.
  -  Not for commercial use. For residential use only .
  -  Stains may be removed with mild soap solution and damp cloth.
- 
-  Dust and pick-up spills using a clean, non-colored, lint-free cloth .