

Assembly Instructions

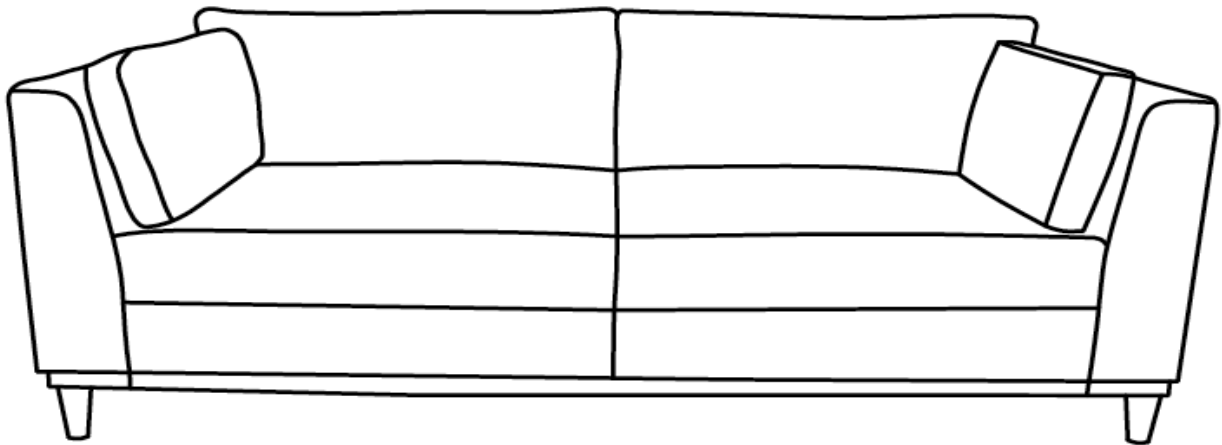



Caution : You must read this before you proceed

Sofa

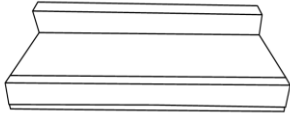
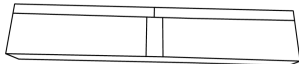

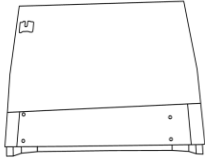
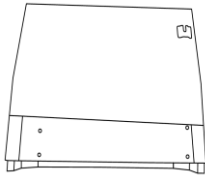

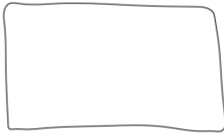

Parts List

| Label | Picture | Description | QTY |
|-------|---|----------------|-----|
| A |  | Seat Panel | 1 |
| B |  | Backrest Panel | 1 |

| | | | |
|---|---|-----------------|---|
| C |  | Right Arm Panel | 1 |
| D |  | Left Arm Panel | 1 |
| E |  | Seat Cushion | 2 |
| F |  | Back Cushion | 2 |
| G |  | Arm Cushion | 2 |
| H |  | Sofa Leg | 7 |

Hardware

| Label | Picture | Description | QTY |
|-------|---|----------------|-----|
| ① |  | Bolt (M8*50MM) | 11 |
| ② |  | Washer | 11 |
| ③ |  | Spring Washer | 11 |
| ④ |  | Allen Wrench | 1 |
| ⑤ |  | Washer Ring | 10 |

Assembly Preparation

Before
Beginning
Assembly:

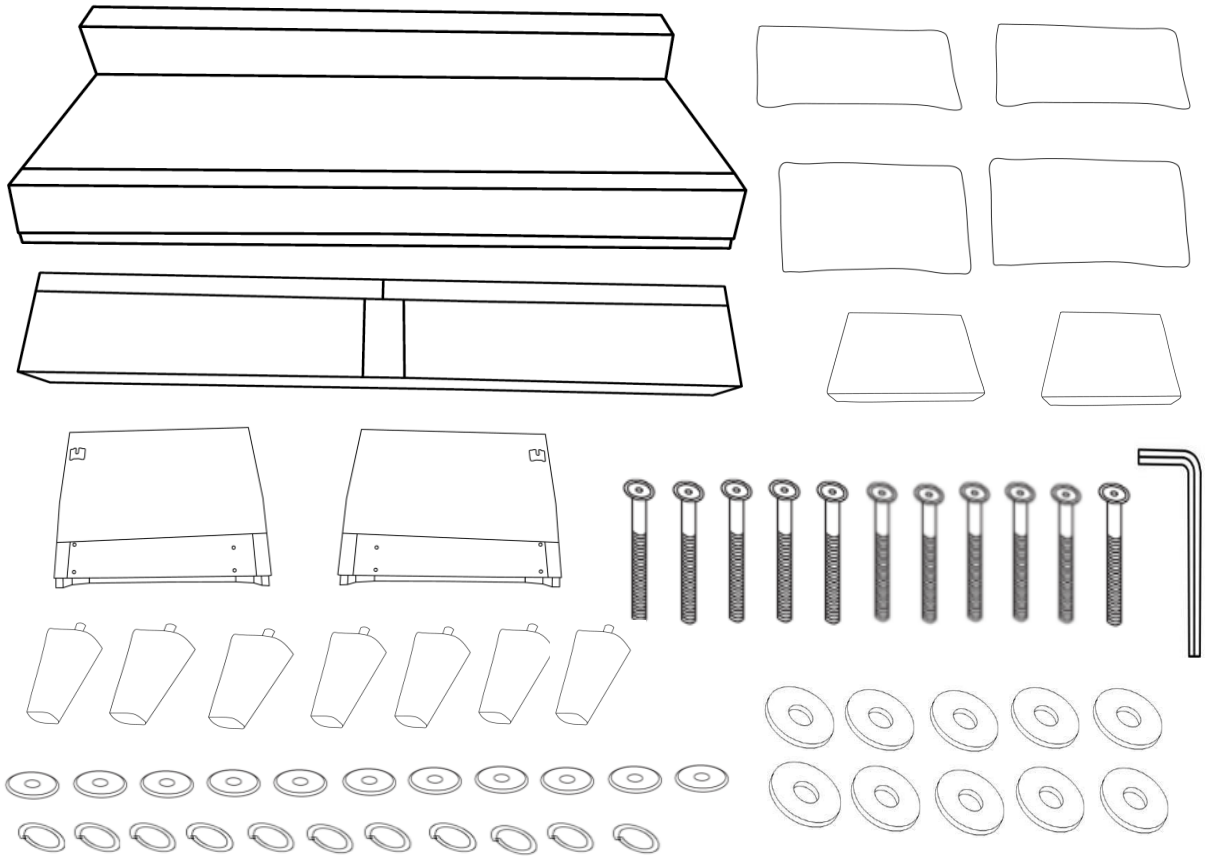

- Read instructions, cover to cover-



- Have 2 adults on hand for assembly-



- Do not assemble on flooring or carpet-



- Assemble on a clean non-marring surface (packing foam)-



- Save all packaging until finished-

Assembly Steps

Overview

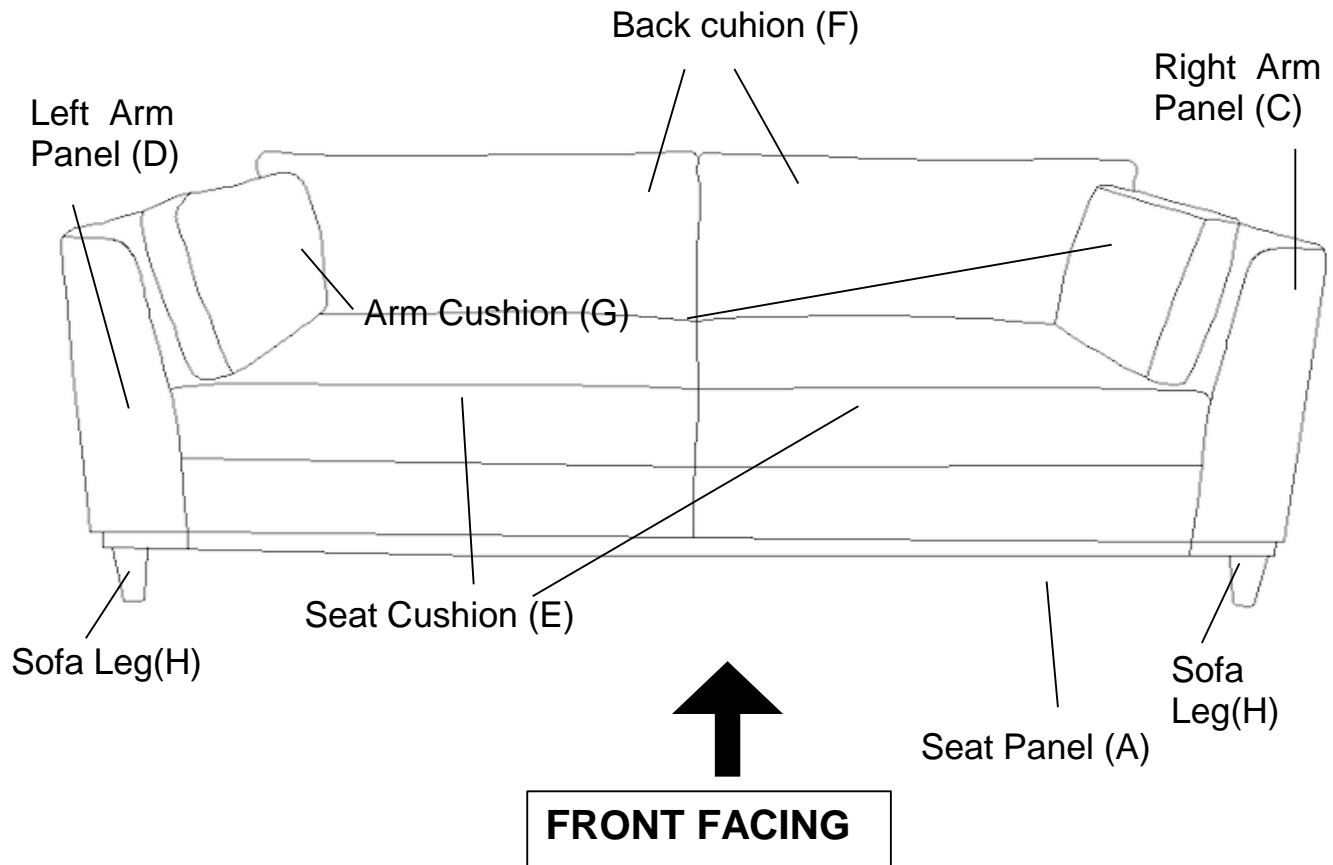

This Sofa has multiple parts and may require up to 30 minutes to assemble. To give you an overview of the Sofa parts, the above picture is to help you put the various parts into perspective. Please read through the instructions herebelow to familiarise yourself with the parts and steps before assembly.

Step 1

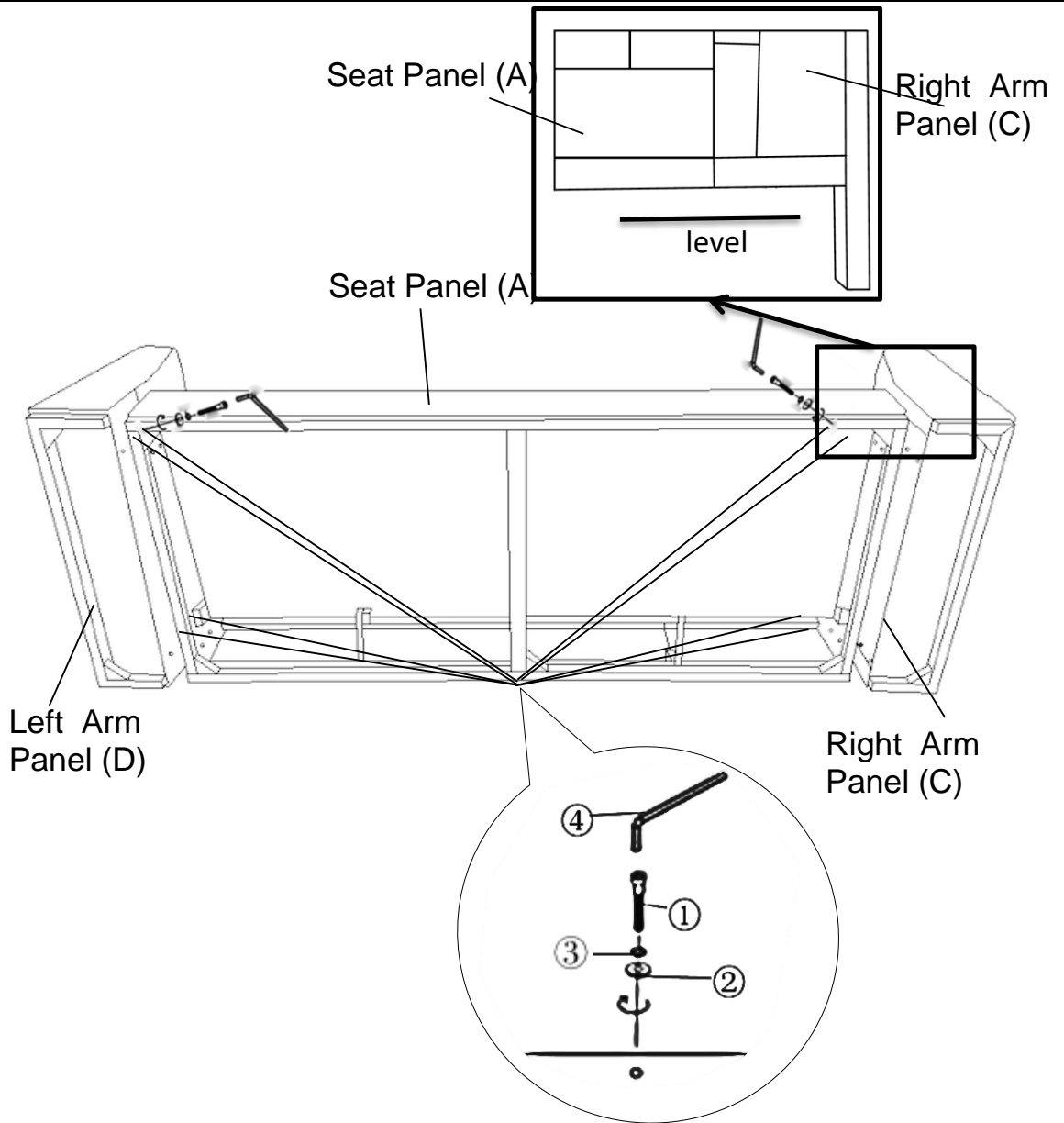

First align the Seat Panel (A), the Right Arm Panel (C) and the Left Arm Panel (D) as shown in the figure, and use the Allen Wrench (④) on the left and right armrests to connect the Bolts (①) as shown in the figure. Affix them into the corresponding assembly holes using Washers (②) and Spring Washers (③) Fully locked position: Check and assess that the Arm Panels(C&D) and Seat Panel(A) are aligned and level.

Step 2

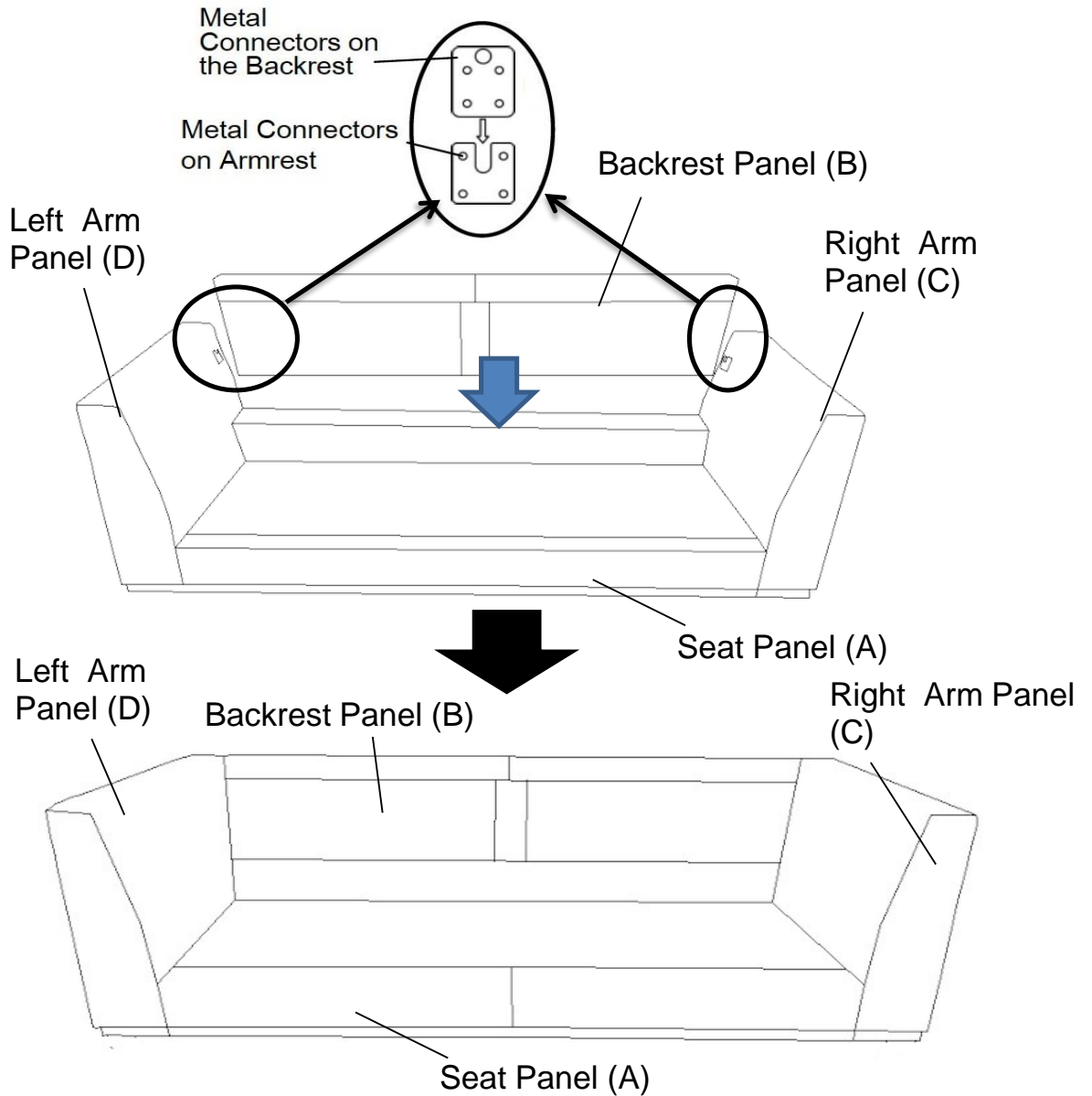

Turn the sofa upright. Hold the Backrest Panel (B) toward the sofa, as shown in the figure. The inserts on the left and right sides of the Backrest Panel (B) need to correspond to the Left Arm Panel (D) and the Right Arm Panel (C) respectively. Insert the position of the inserts on the upper side, and lock them as shown in the figure above.

Step 3

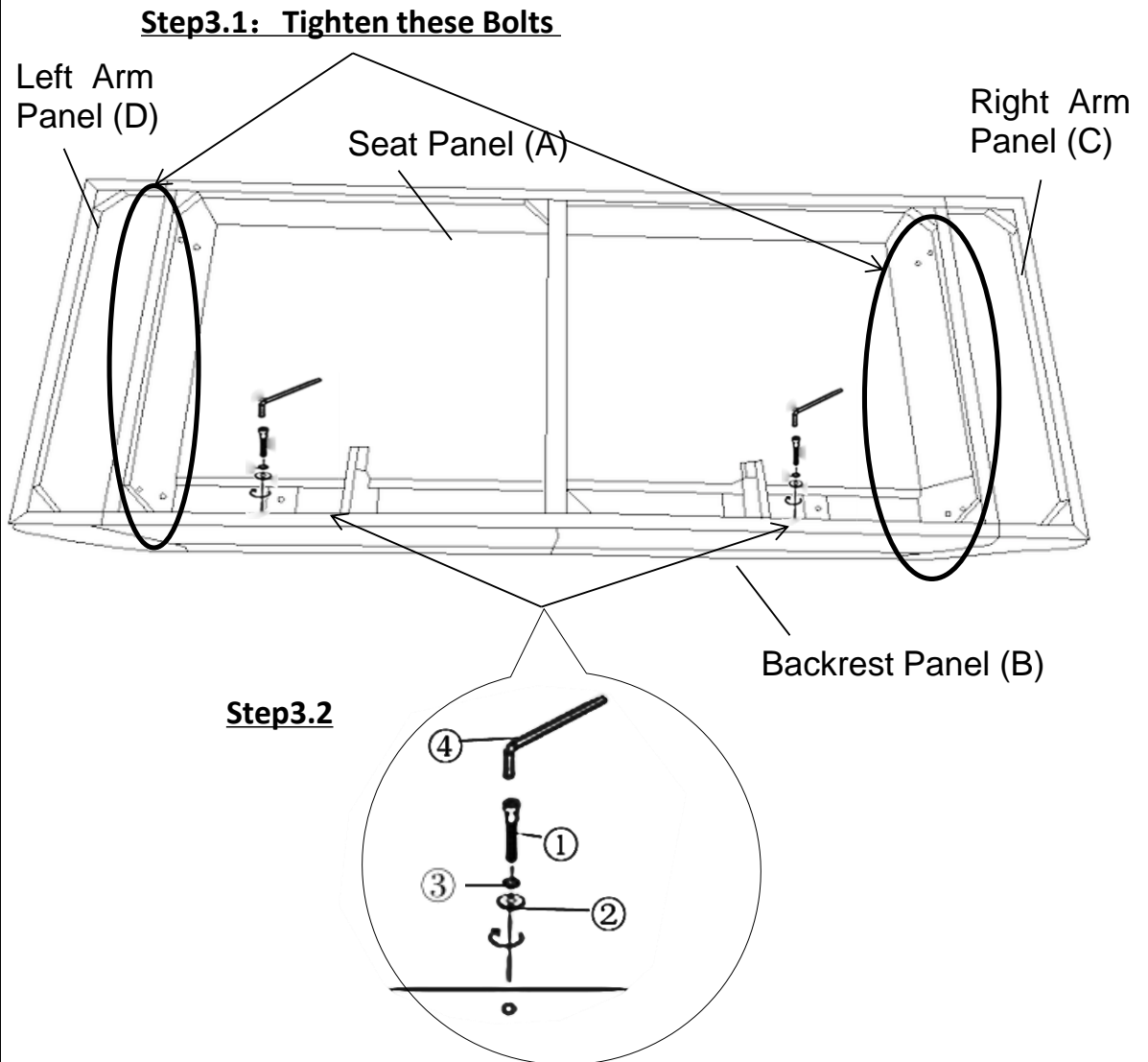

Step3.1: Turn the sofa back onto its back to lock the Left Arm Panel (D) And Right Arm Panel (C) into place.

Fully tighten the bolts that were not locked before on both sides.

Step3.2: Then use the Allen Wrench (④) to insert Bolts (①), Washers (②) and Spring Washers (③) into the corresponding two holes to affix together the Backrest Panel (B) And the Seat Panel (A)

Step 4

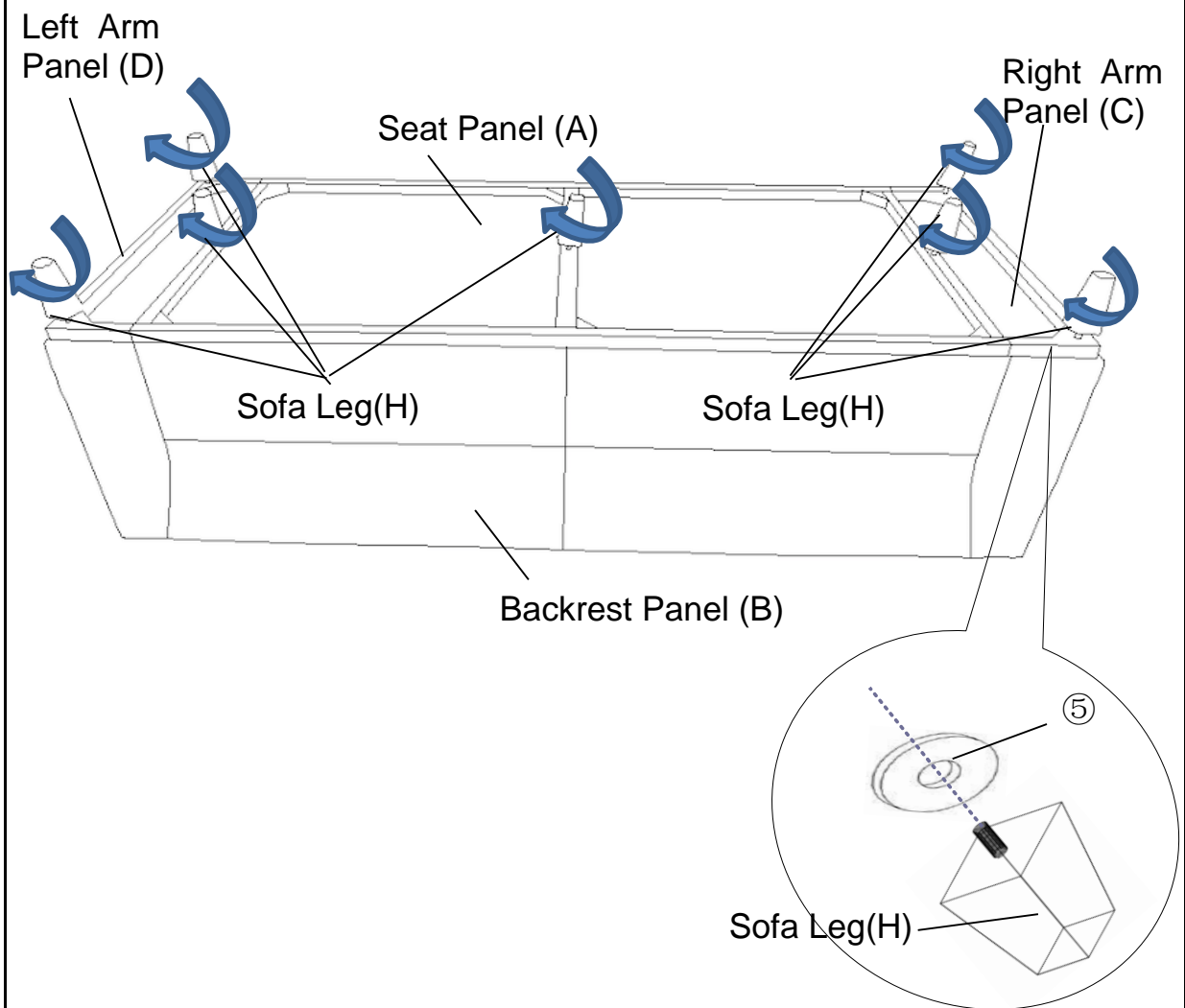

Insert the Sofa Legs (H) with a Washer Ring (5) into the corresponding mounting holes in the bottom of each panel, turning each leg clockwise to tighten, as shown in the above picture

Step 5

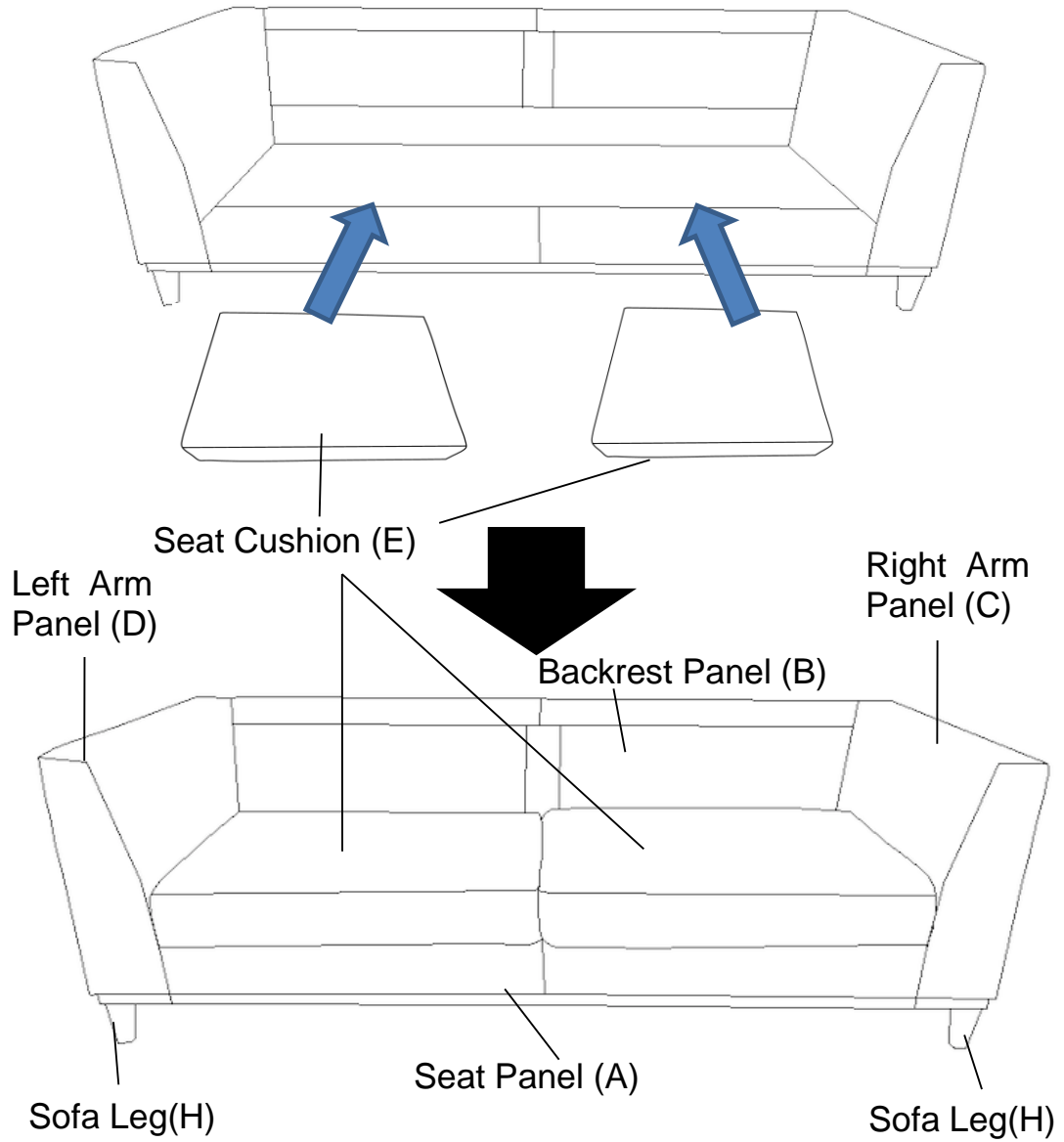

Put two Seat Cushions (E) on the Seat Panel (A)

Step 6

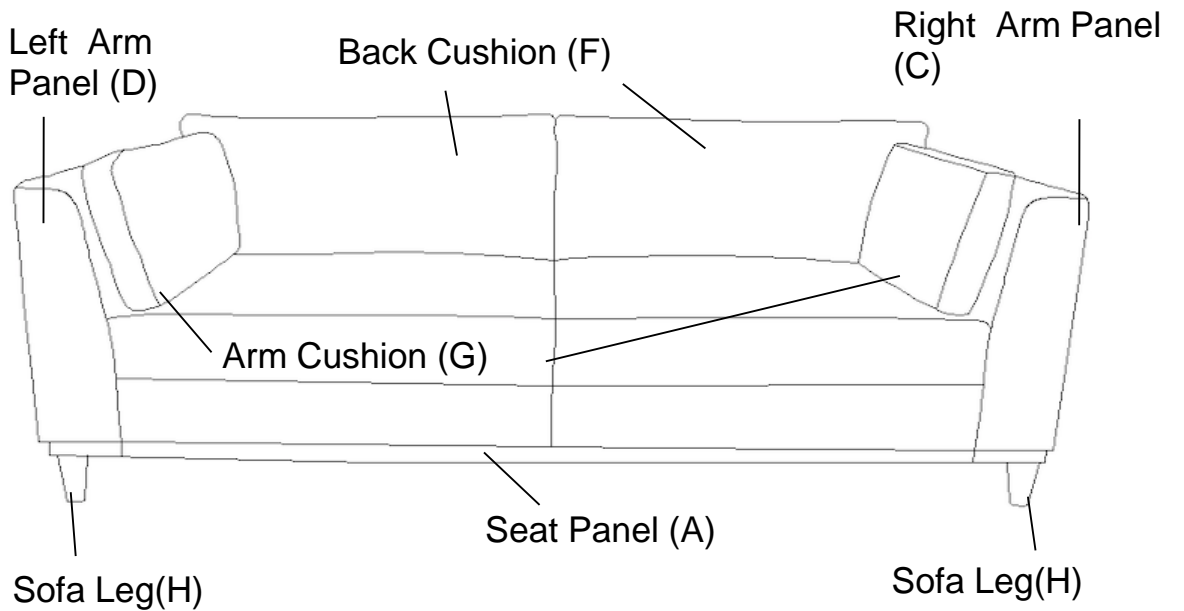

Finally, put the two Back Cushions (F) and the two Arm Cushions (G) on the assembled sofa as shown in the figure, and the sofa is ready for use.

This Sofa can only be used on a flat, level surface.

Care & Maintenance



- Furniture may scratch floors. We recommend using furniture pads to protect your floors.



- Do not put hot items directly on furniture surface.



- Do not clean furniture with harsh cleansers or polish.



- Do not place furniture under direct sunlight.



- Do not place furniture near heating or cooling vents.



- Do not write on furniture without a padded barrier to protect the surface.



- Do not place furniture outside . For indoor use only.



- Not for commercial use. For residential use only.



- Stains may be removed with mild soap solution and damp cloth.



- Children should not climb or jump on the furniture.



- Dust and pick-up spills using a clean, non-colored, lint-free cloth.