

# Assembly Instructions

**Caution : You must read this before you proceed**



## Barstool

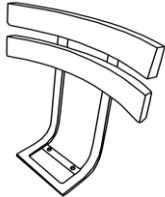

### Parts List

Label	Picture	Description	QTY
A		Seat	1
B		Backrest	1

# Hardware

Label	Picture	Description	QTY
①		Nut	5
②		Wrench	1

# Assembly Preparation

**Before Beginning Assembly:**

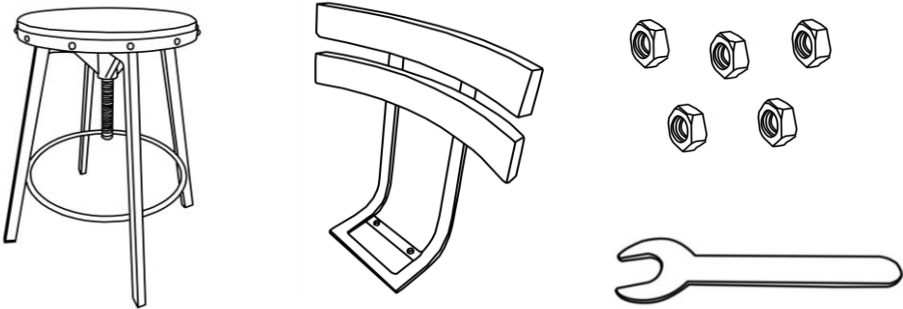

- Read instructions, cover to cover-



- Have 2 adults on hand for assembly-



- Do not assemble on flooring or carpet-



- Assemble on a clean non-marring surface (packing foam)-



- Save all packaging until finished-

# Assembly Steps

## Overview

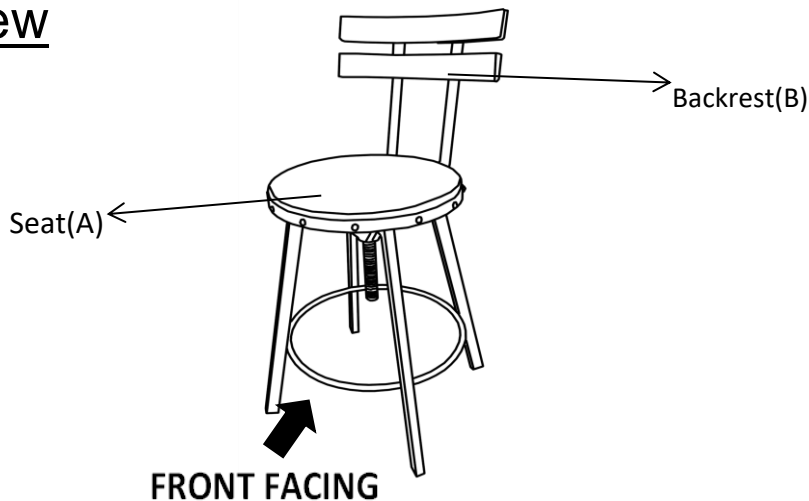

This Barstool has multiple parts and may require up to some 30 minutes to assemble. To give you an overview of the Barstool parts, the above picture is to help you put the various parts into perspective. Please read through the instructions below to familiarise yourself with the parts and steps before assembly.

### Step 1

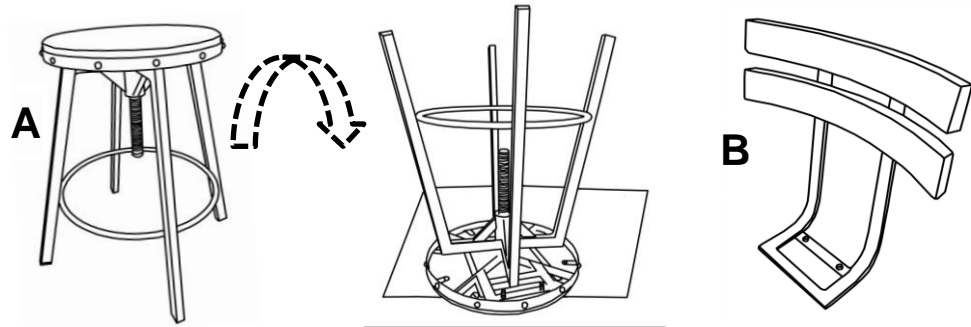

Put the parts on a clean, non-marring surface.  
Place the Seat (A) facedown onto a table, as shown.

### Step 2

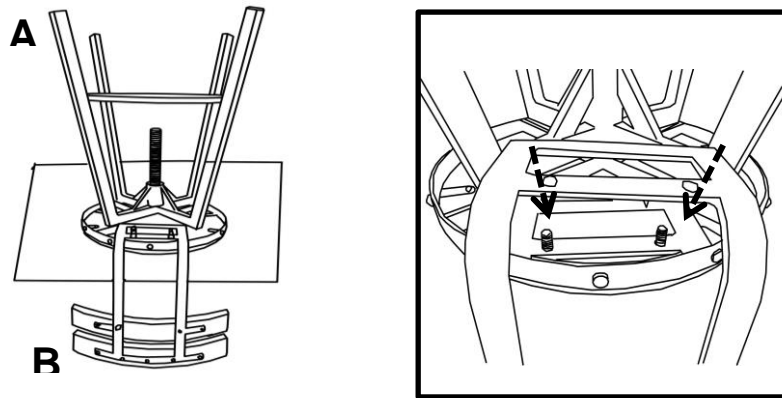

Align the mounting positions on the Seat(A) and the Backrest(B).

### Step 3

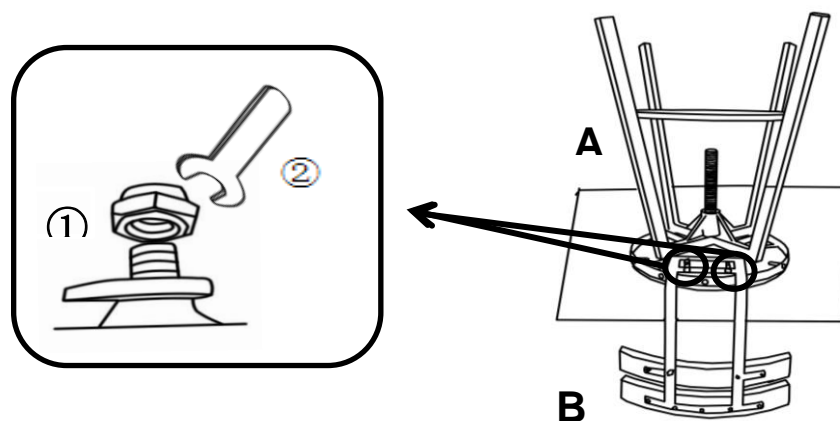

Attach Seat (A) to Backrest(B) using Nuts(①) with Wrench(②).  
**CAUTION :** When tightening these Nuts, tighten sequentially.  
**DO NOT** tighten any screw fully and then towards the next one.

Step 4

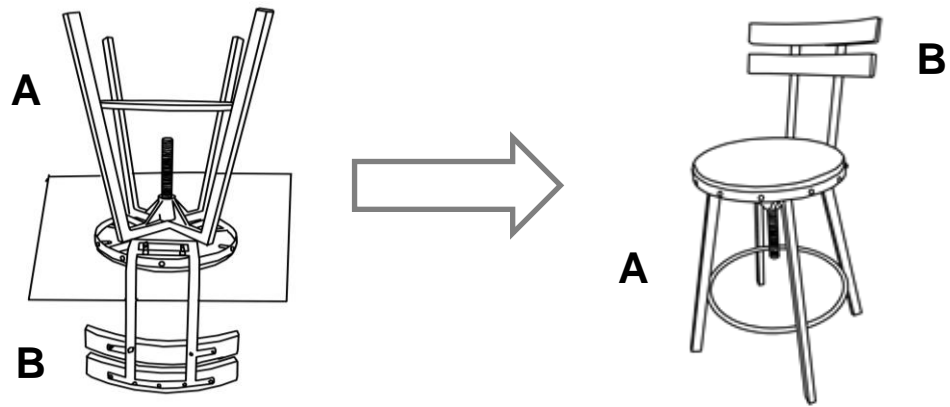

Stand the Barstool up and check the firmness of backrest, tighten all nuts.  
**WARNING!! IF BARSTOOL BACKREST IS NOT FIRMNESS, IT COULD LEAD TO DAMAGING THE PRODUCT.**

Step 5

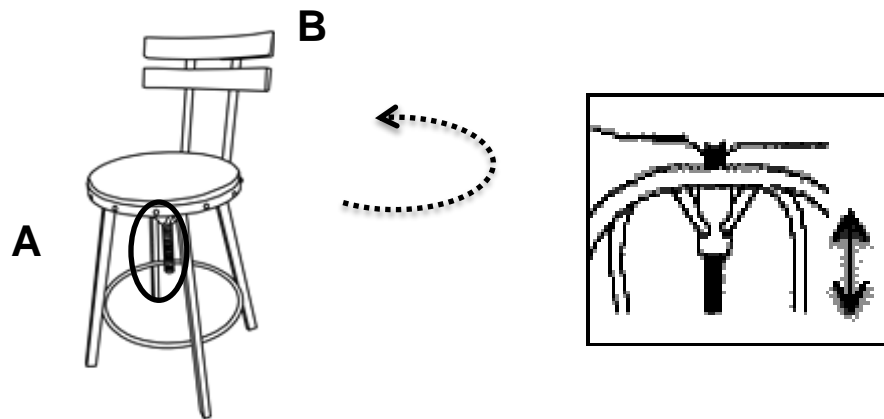

Revolve the Seat(A) to adjust the Barstool's height.

Step 6



Your Barstool is ready for use.  
This Barstool can only be used on a flat, level surface.

## Care & Maintenance



- Furniture may scratch floors. We recommend using furniture pads to protect your floors.



- Do not put hot items directly on furniture surface.



- Do not clean furniture with harsh cleansers or polish.



- Do not place furniture under direct sunlight.



- Do not write on furniture without a padded barrier to protect the surface.



- Do not place furniture outside . For indoor use only.



- Not for commercial use. For residential use only.



- Stains may be removed with mild soap solution and damp cloth.



- Children should not climb or jump on the furniture.



- Dust and pick-up spills using a clean, non-colored, lint-free cloth.