

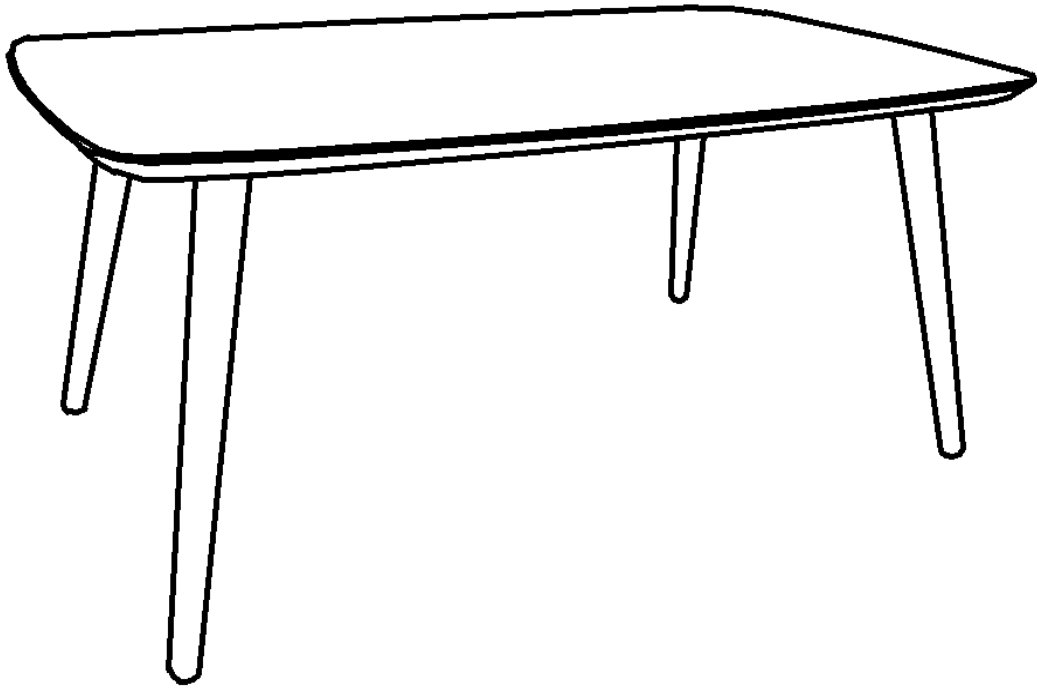

Assembly Instructions

Caution : You must read this before you proceed

COFFEE TABLE

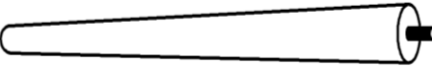

Part List

Label	Picture	Description	QTY
A		Table Top	1
B		Leg	4

Hardware

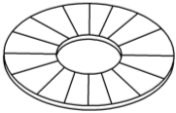
Label	Picture	Description	QTY
①		Gasket	7

Assembly Preparation

Before Beginning Assembly:

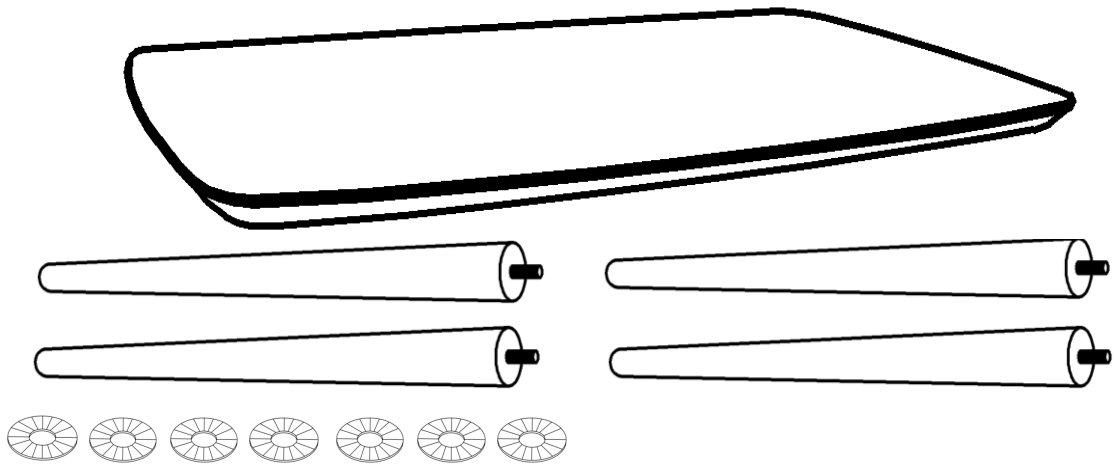

- Read instructions, cover to cover-



- Have 2 adults on hand for assembly-



- Do not assemble on flooring or carpet-



- Assemble on a clean non-marring surface (packing foam)-



- Save all packaging until finished-

Assembly Steps

Overview

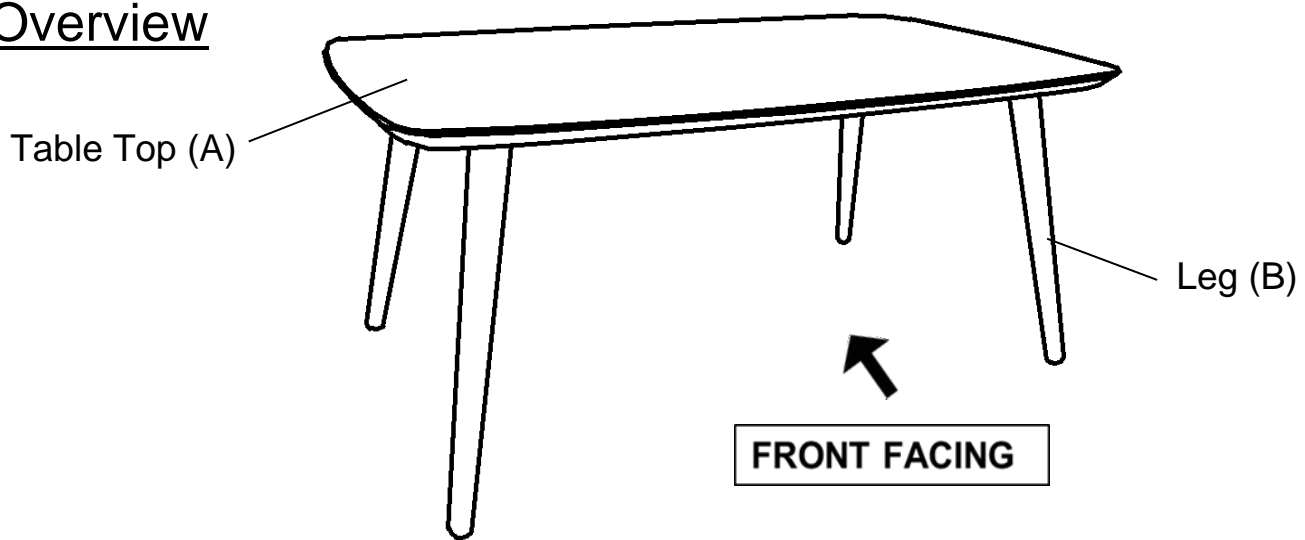

This Coffee Table has multiple parts and may require up to 30 minutes to assemble. To give you an overview of the Coffee Table parts, the above picture is to help you put the various parts into perspective. Please read through the instructions below to familiarise yourself with the parts and steps before assembly.

Step 1

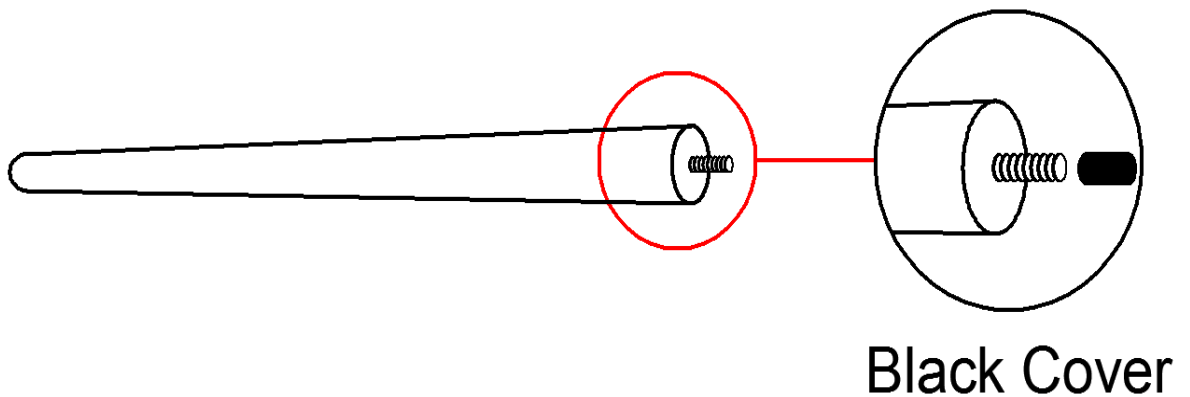

Open the carton and place all parts onto a clean, non-marring surface. Remove the Black Cover on the threaded stem of the Legs(B).

Step 2

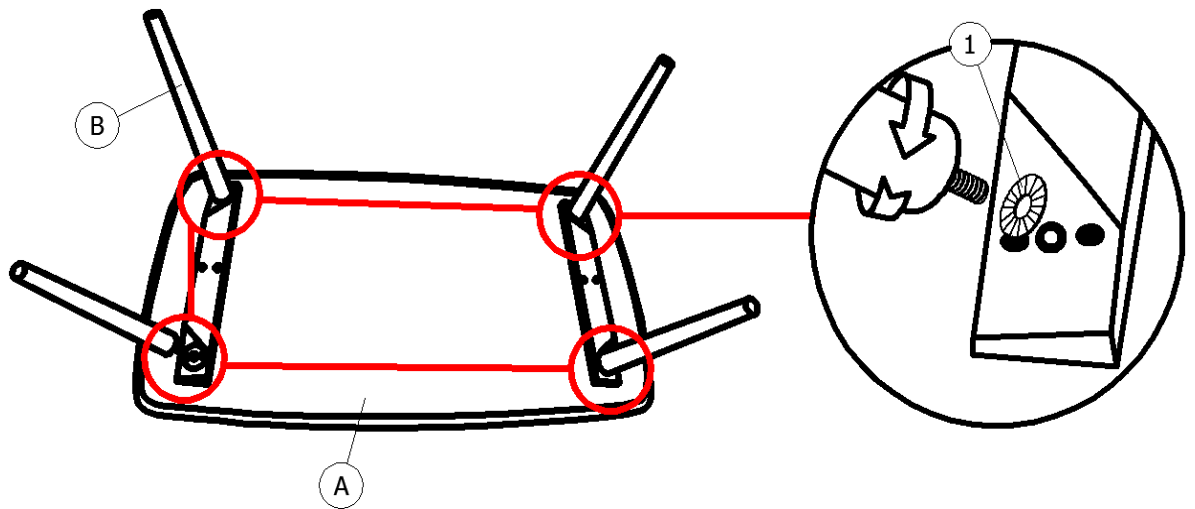

Place Table Top(A) facedown as pictured above.
Install the Legs(B) into the bottom of the Table Top(A) by placing a Gasket(①) onto the threaded stem of the Legs.
And then insert the threaded stem into the threaded mounting position at each Corner of the Bottom of the Table Top(A).
Tighten by turning the Legs clockwise.

Position Table right side up and test for stability on a Level Surface.
Note: The use of Gaskets are OPTIONAL and are especially useful to help alleviate slight wobbles. Some Legs may need more than one whilst some Legs do not need any.



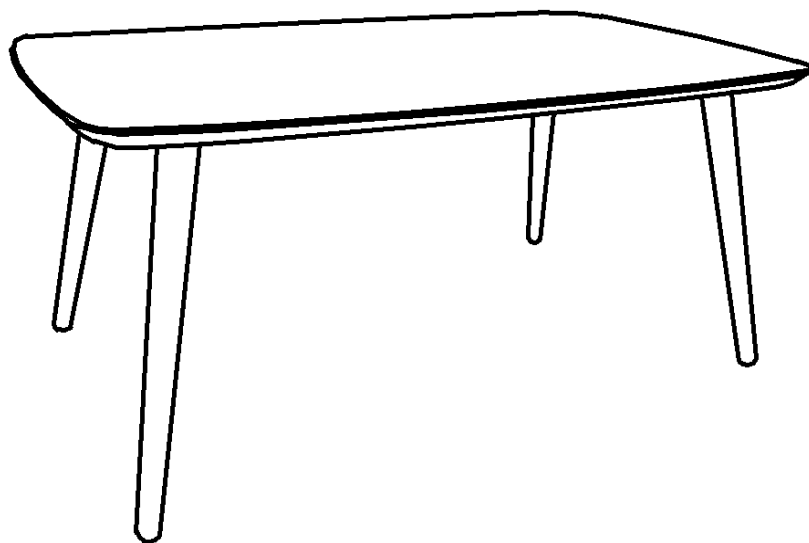







Step 3



With assistance from your adult partner, stand the Table up.
Your Coffee Table is now ready for use.
This Coffee Table can be only used on a flat, level surface.

Care & Maintenance

Care & Maintenance

- ⊘  ● Do not put hot items directly on furniture surface
 - ⊘  ● Do not clean furniture with harsh cleansers or polish.
 - ⊘  ● Do not place furniture under direct sunlight.
 - ⊘  ● Do not place furniture near heating or cooling vents.
 - ⊘  ● Do not write on furniture without a padded barrier to protect the surface.
 - ⊘  ● Do not place furniture outside . For indoor use only .
 - ⊘  ● Not for commercial use. For residential use only .
 - ⊘  ● Stains may be removed with mild soap solution and damp cloth.
 - ⊘  ● Children should not climb or jump on the furniture.
-
- ✓  ● Dust and pick-up spills using a clean, non-colored, lint-free cloth .

What is Proposition 65?

Proposition 65 is a California law that requires warning labels on products that may contain one of more than 800-plus chemicals or ingredients that the California Office of Environmental Health Hazard Assessment (OEHHA) has deemed to cause cancer or other reproductive toxicity. Chemicals and elements on this list include wood dust, brass, and other everyday substances, which can be found in very common household items, such as: lamps, tableware, jewelry, crystal glasses, electric cords, beauty products, automobiles, and furniture.

Why Did I Find a Proposition 65 Warning on My Home Goods Product?

We include Proposition 65 warnings on all of our products because there is always a chance that one of the 800-plus common chemicals and ingredients listed under this law could potentially be on our furniture or packing materials. We risk large fines under this law, if we don't include this warning.

Should I worry?

We realize you may be worried finding this warning on our products, but we want to reassure you that the hazardous exposure limits for any of these chemicals have never been found on furniture products that we've shipped to our customers. Additionally, this warning label is very common and can be found on almost every piece of furniture sold in the state of California.

Just How Common Are Proposition 65 Warnings?

Proposition 65 warnings have become so common in California that it is hard to take a trip to a local bank, grocery store, or restaurant without finding at least one warning. In fact, even the Disney Land Resort has a Proposition 65 warning:

