

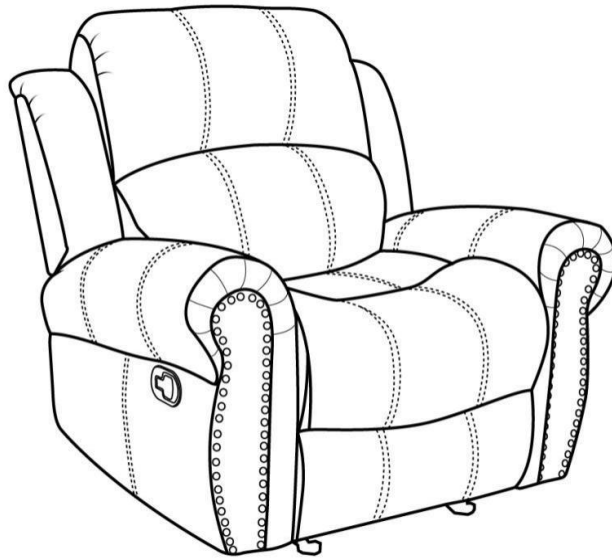



Assembly Instructions

Caution : You must read this before you proceed

RECLINER

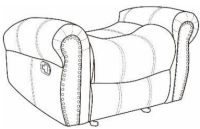

Parts List

Label	Picture	Description	QTY
A		Chair Backrest	1
B		Left Wing (Labelled B)	1
C		Right Wing (Labelled C)	1
D		Chair Base with Footrest	1

Assembly Preparation

Before Beginning Assembly:

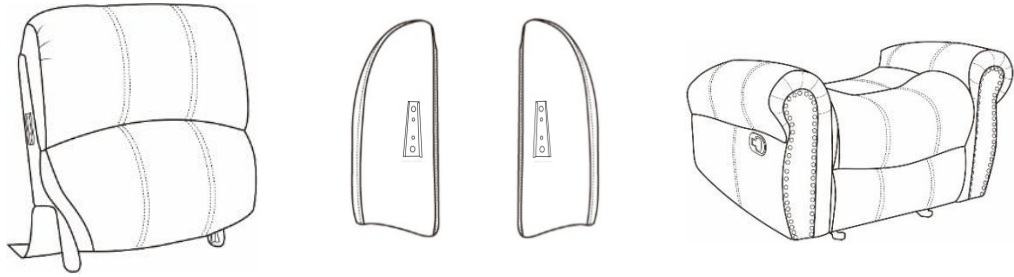

- Read instructions, cover to cover-



- Have 2 adults on hand for assembly-



- Do not assemble on flooring or carpet-



- Assemble on a clean non-marring surface (packing foam)-



- Save all packaging until finished-

Assembly Steps

Overview

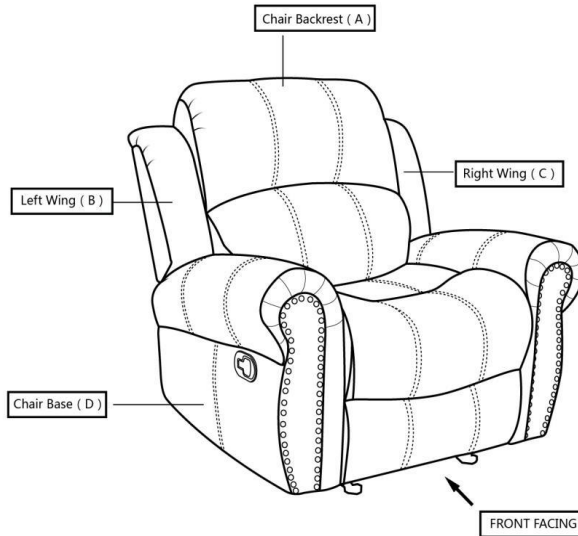

This Recliner has multiple parts and may require up to some 30 minutes to assemble. To give you an overview of the Recliner parts, the above picture is to help you put the various parts into perspective. Please read through the instructions below to familiarise yourself with the parts and steps before assembly.

Step 1

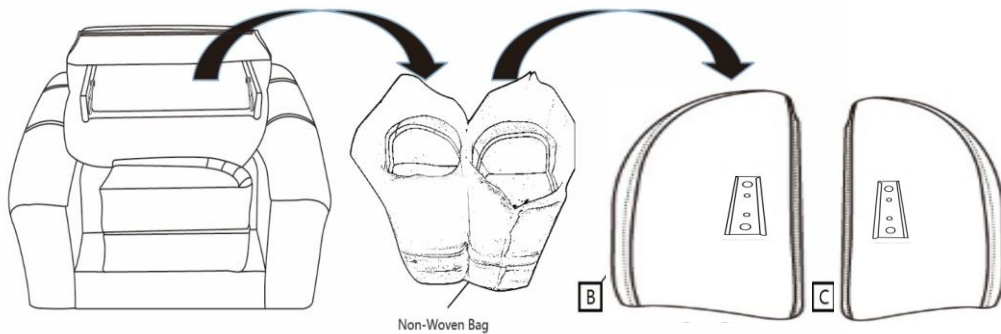

Take out 2 wings from the none woven bag, which is put on the back of the recliner seat.

Step 2

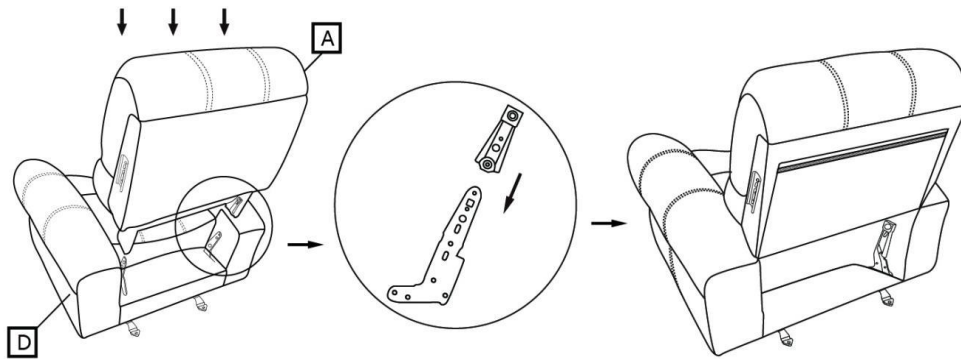

With assistance from your adult partner, hold up the Chair Backrest(A), while standing behind the Chair. Insert the small metal arms on the sides of the Chair Backrest(A) into the prefabricated slide lock gadget on the Chair Base with Footrest(D) as shown above. Firmly but gently, push the Chair Backrest(A) downwards until the Backrest is fully slotted and locked into position.

Step 3

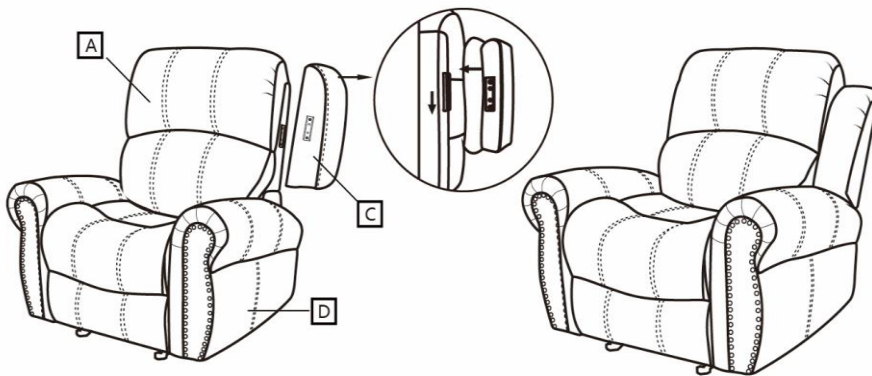

Align the mounting brackets of the Right Wing(C) with those on the right side of Chair Backrest(A). Then slide Right Wing(C) down by hand to make sure it locks into the position as shown in the picture.

Step 4

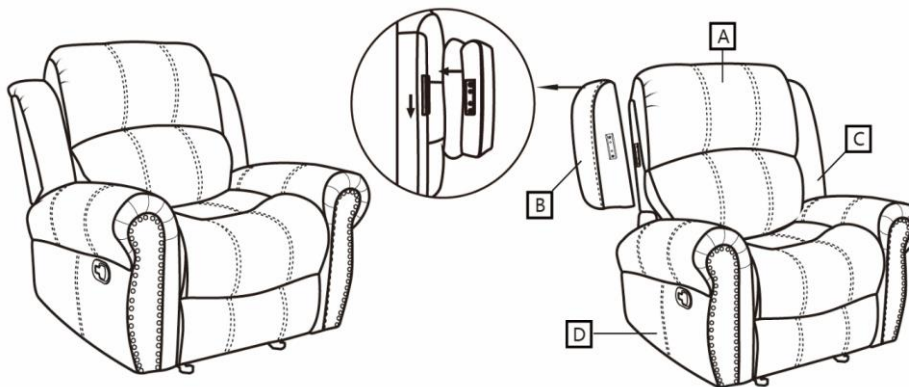

Align the mounting brackets of the Left Wing(B) with those on the left side of Chair Backrest(A). Then slide Left Wing(B) down by hand to make sure it locks into the position as shown in the picture.

Step 5

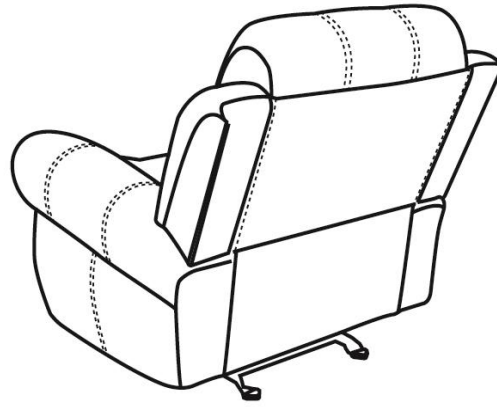

Smooth down the fabric flap on the Chair Backrest(A).
Run your hands down both sides of the flap, from top to bottom, allowing the velcro tape to adhere to the flap under the seat of the chair.

Step 6

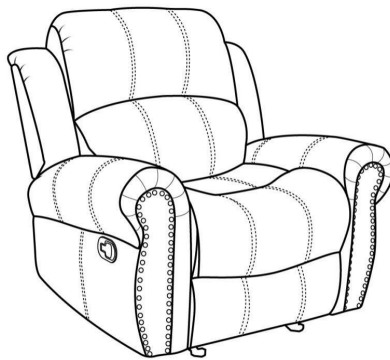

Make sure all parts are connected and securely locked into position.
Your Recliner is ready for use.

Step 7

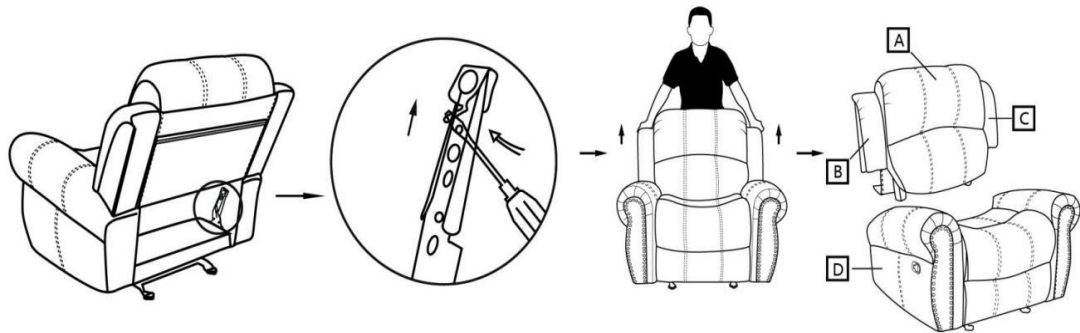

To disassemble the Chair Backrest(A).
Open the back flag on the right side with a flat screwdriver and pull the metal slightly.
Pull up the right side of Chair Backrest(A).
Then repeat the same process with the left side of the Chair Backrest(A).

User Instructions.

Recliner Chair

Please read the Instruction Manual below carefully before use.

Children must be supervised when using this Recliner Chair.

Warning

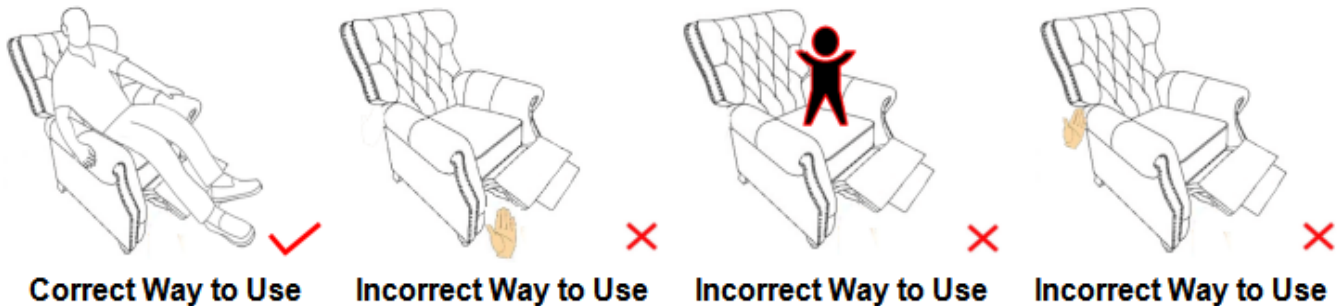

Do not let children stand in front of or behind the Reclining Chair when opening or closing the footrest.
Do not put your hands inside the Footrest when opening or closing the footrest.
Do not sit any side of Chair.

Do not open trigger when you want to close the Footrest, just push it by your feet.

To get into a reclined posture - To Recline backrest

Sit into the seat.
Open the trigger on the outside of right armrest.
Use your body weight and push backwards into the seat into a fully reclined position.

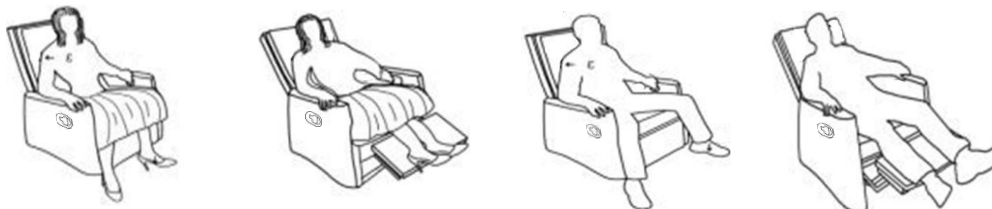





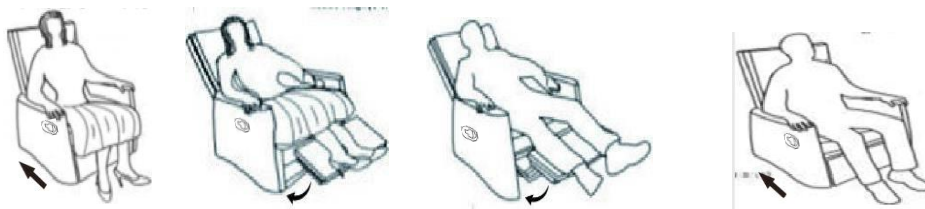





To get out of chair - move Seatback into Upright Position

Tilt your body weight slightly forward and upwards.
The seat back will come up to an upright position.
Use your feet to push the footrest down.
The chair will automatically lock when it is in the fully upright position.
Where necessary, use your arms help lift/push yourself out of the seat.



Care & Maintenance

	<ul style="list-style-type: none">● Furniture may scratch floors. We recommend using furniture pads to protect your floors.
	<ul style="list-style-type: none">● Do not put hot items directly on furniture surface.
	<ul style="list-style-type: none">● Do not clean furniture with harsh cleansers or polish.
	<ul style="list-style-type: none">● Do not place furniture under direct sunlight.
	<ul style="list-style-type: none">● Do not place furniture near heating or cooling vents.
	<ul style="list-style-type: none">● Do not write on furniture without a padded barrier to protect the surface.
	<ul style="list-style-type: none">● Do not place furniture outside . For indoor use only.
	<ul style="list-style-type: none">● Not for commercial use. For residential use only.
	<ul style="list-style-type: none">● Stains may be removed with mild soap solution and damp cloth.
	<ul style="list-style-type: none">● Children should not climb or jump on the furniture.
	<ul style="list-style-type: none">● Dust and pick-up spills using a clean, non-colored, lint-free cloth.