

Assembly Instructions

Caution: You must read this before you proceed

Care & Maintenance



- Not for commercial use. For residential use only.



- Furniture may scratch floors. We recommend using furniture pads to protect your floors.



- Do not put hot items directly on furniture surface.



- Do not clean furniture with harsh cleansers or polish.



- Do not place furniture under direct sunlight.



- Do not place furniture near heating or cooling vents.



- Do not write on furniture without a padded barrier to protect the surface.



- Do not place furniture outside . For indoor use only.



- Stains may be removed with mild soap solution and damp cloth.



- Children should not climb or jump on the furniture.





- Dust and pick-up spills using a clean, non-colored, lint-free cloth.

Please look in the legs for hardware pack.

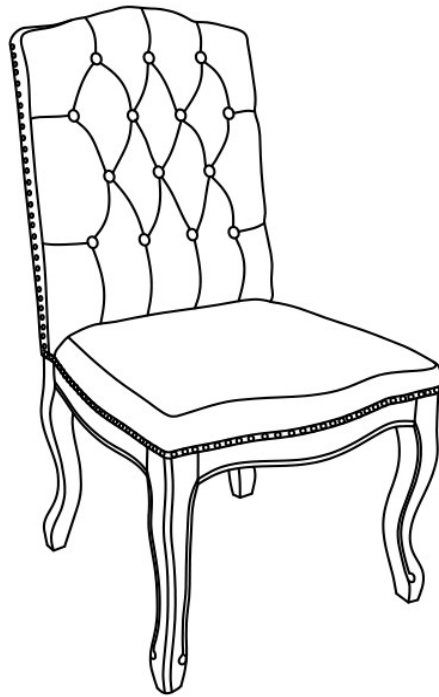

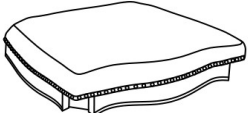
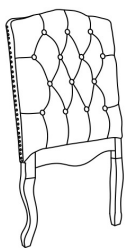

Chair



Parts List

Label	Picture	Description	QTY
A		Seat	1
B		Backrest	1
C		Front Leg	2





Hardware

Label	Picture	Description	QTY
①		Bolt (M8*60MM)	9
②		Spring Washer	9
③		Washer	9
④		Allen Key	1

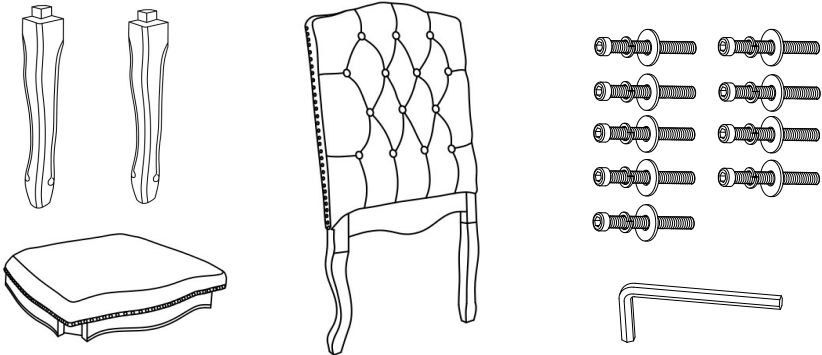
Assembly Preparation

Before Beginning Assembly:



-  • Read instructions, cover to cover-
-  • Have 2 adults on hand for assembly-
-  • Do not assemble on flooring or carpet-
-  • Assemble on a clean non-marring surface (packing foam)-
-  • Save all packaging until finished-

Assembly Steps

Overview

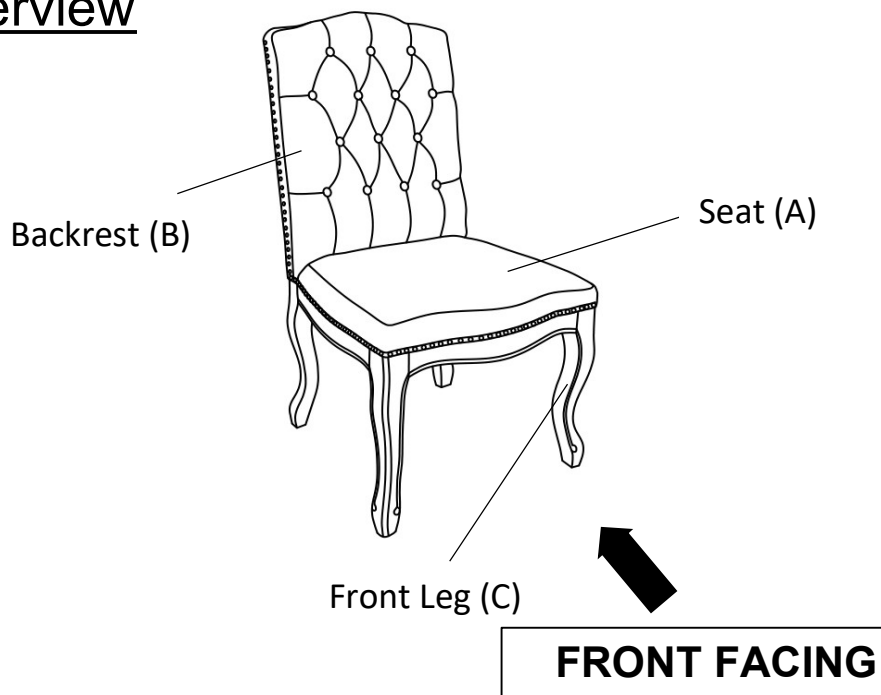

This Chair has multiple parts and may require up to 30 minutes to assemble. To give you an overview of the Chair parts, the above picture is to help you put the various parts into perspective. Please read through the instructions below to familiarise yourself with the parts and steps before assembly.

Step 1

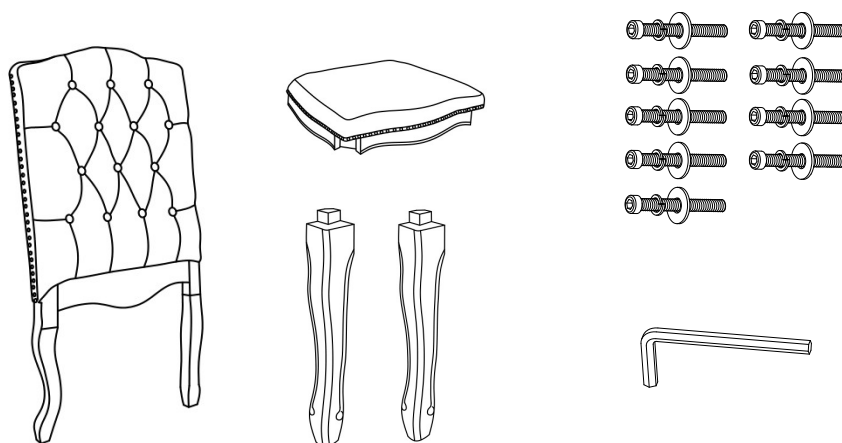

Unpack and place all parts on a clean, non-marring surface.

Step 2

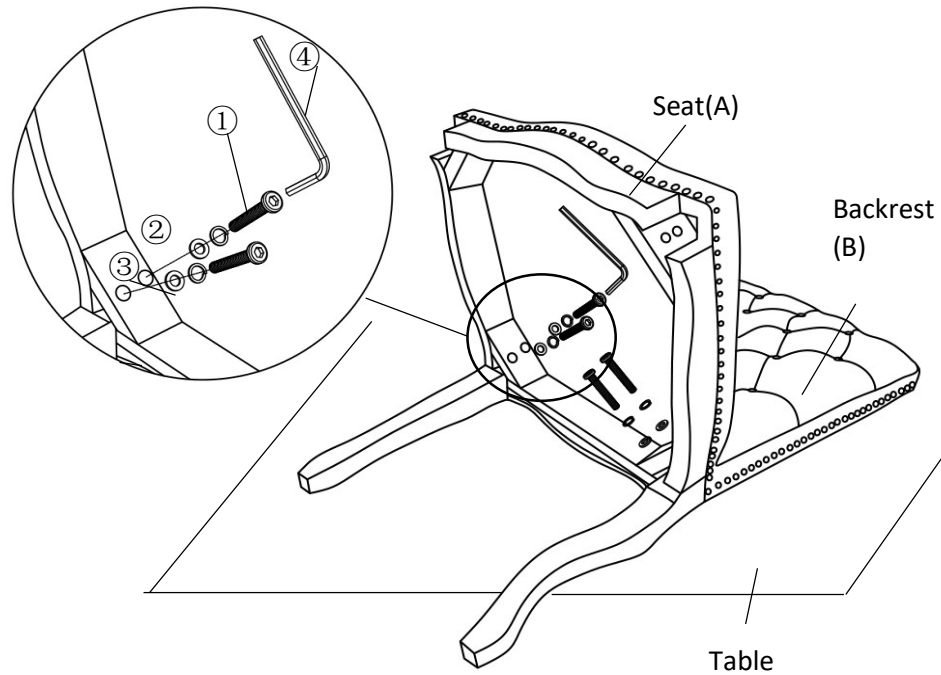

Place the Backrest(B) on a clean, non-marring surface. Align the mounting positions of Seat(A) to Backrest(B), then attach using Bolts(①), Spring Washers(②) and Washers(③) with Allen Key(④).

Friendly notice:

If the mounting positions cannot be aligned well which hinders the installation, then sway the Seat(A) lightly when locking the Bolts, this action could help prevent the Bolts from getting stuck and ensure smooth assembly.

Do not fully tighten the Bolts.

Step 3

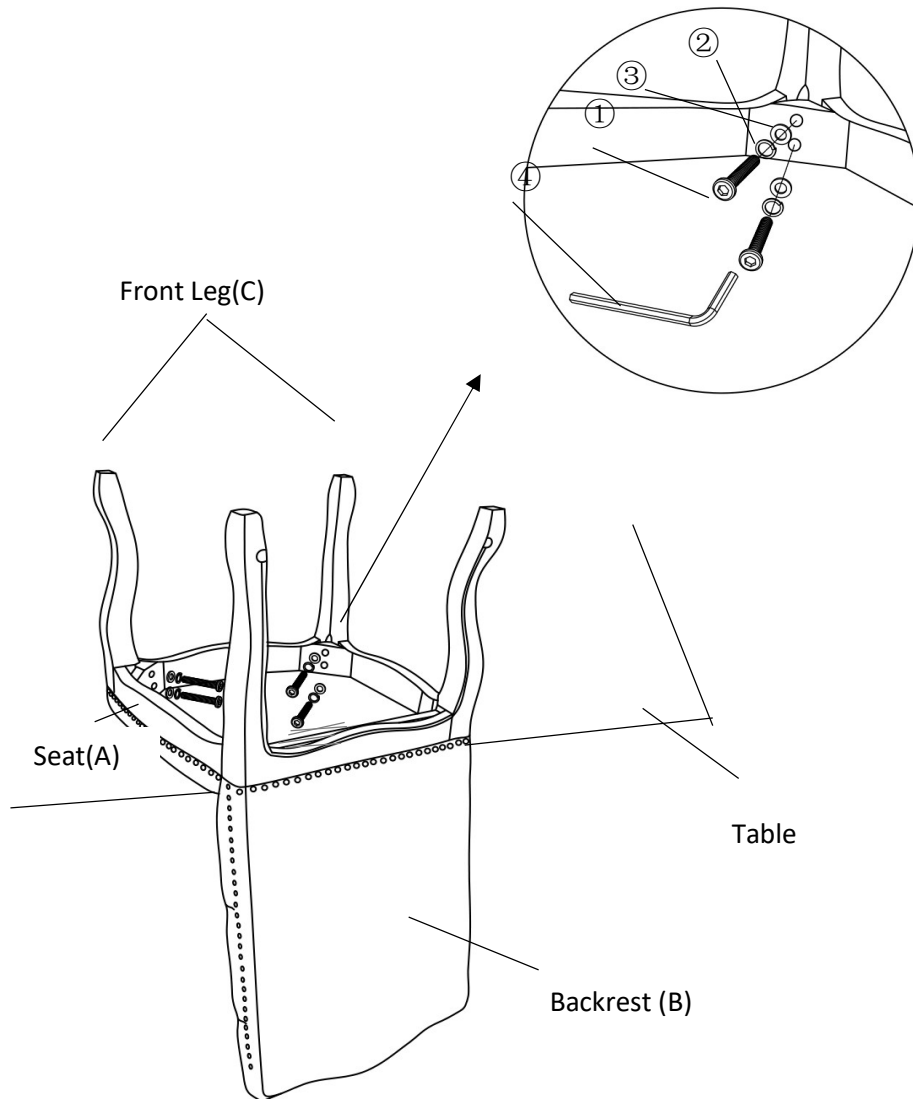

Place the Seat(A) facedown on the edge of a Table, with the Backrest(B) facing down and perpendicular to the Table, as pictured above.

Insert Front Legs(C) into the mounting positions of Seat(A) then attach using Bolts(①), Spring Washers(②), and Washers(③) with Allen Key(④).

Do not fully tighten the Bolts.

Step 4

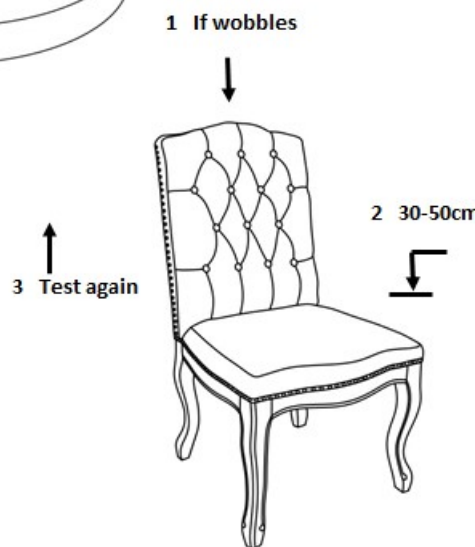

Place the Chair on a level Surface to check if it wobbles.

If it wobbles, lift the Chair some 30cm to 50cm high from the ground. Keep your feet and toes well away from the drop zone.

Drop the Chair freely and vertically, with all four legs hitting the ground at the same time.

This Drop Test will help to ensure that all the Parts, Bolts, and gaps reach full alignment status.

Test again for evenness on a Level Surface.

If no wobbles are found, proceed to tighten all the Bolts.

When tightening the Bolts, tighten sequentially.

Do not fully tighten any Bolt fully and then move on towards the next one.

This may cause the frame to warp.

If there are still wobbles, loosen the Bolts and execute this same drop test.

Step 5

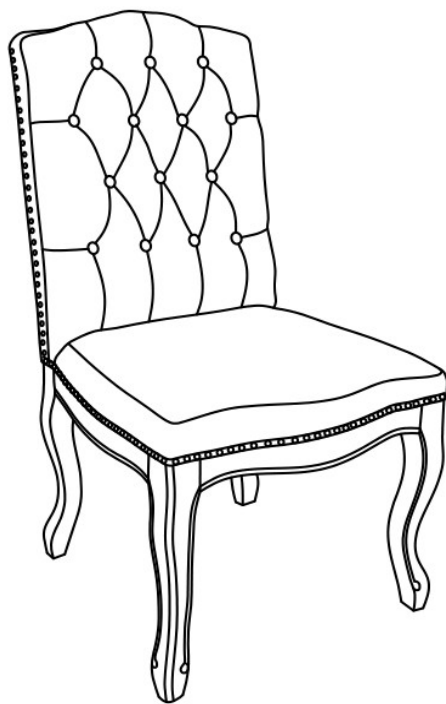

Your Chair is ready for use.

This Chair can only be used on a flat, level surface.