

# Assembly Instructions

Caution: You must read this before you proceed

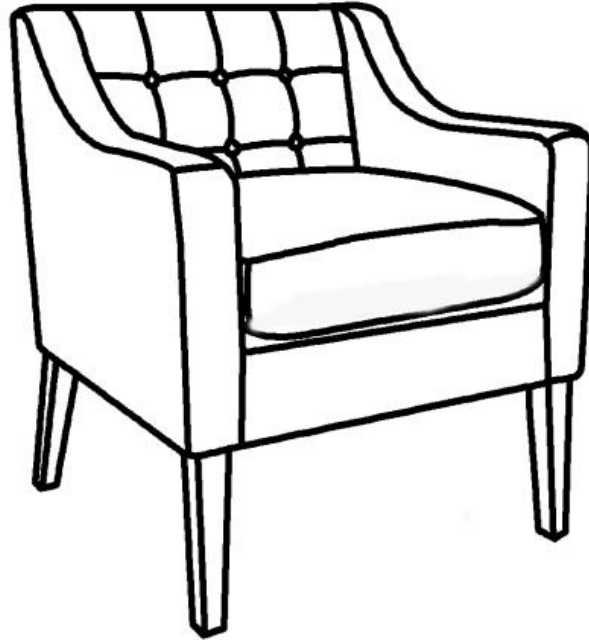

Please look in the seat for hardware packs and legs.

## CHAIR





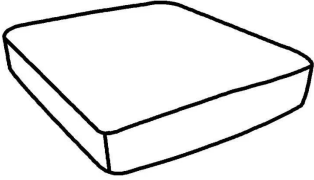

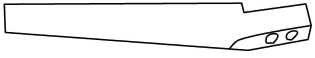
### Parts List

Label	Picture	Description	QTY
A	A small line drawing of the chair's seat base, showing the tufted backrest and the seat area without the legs or armrests.	Seat Base	1









B		Seat Cushion	1
C		Front Leg	2
D		Left Hind Leg	1
E		Right Hind Leg	1

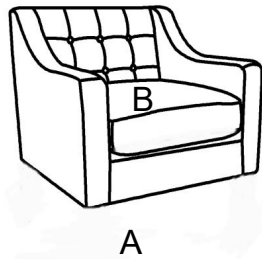



## Hardware List

Label	Picture	Description	QTY
①		Bolt (M8*70mm)	9
②		Washer	9
③		Spring Washer	9

④		Allen wrench	1
---	---	--------------	---

## Assembly Preparation

<p>Before Beginning Assembly:</p>		<p>C  x2</p> <p>D  x2</p> <p>E  x2</p>	<p>①  x9</p> <p>②  x9</p> <p>③  x9</p> <p>④ </p>
-----------------------------------	---	---	--

-  • Read instructions, cover to cover-
-  • Have 2 adults on hand for assembly-
-  • Do not assemble on flooring or carpet-
-  • Assemble on a clean non-marring surface (packing foam)-
-  • Save all packaging until finished-

# Assembly Steps

## Overview

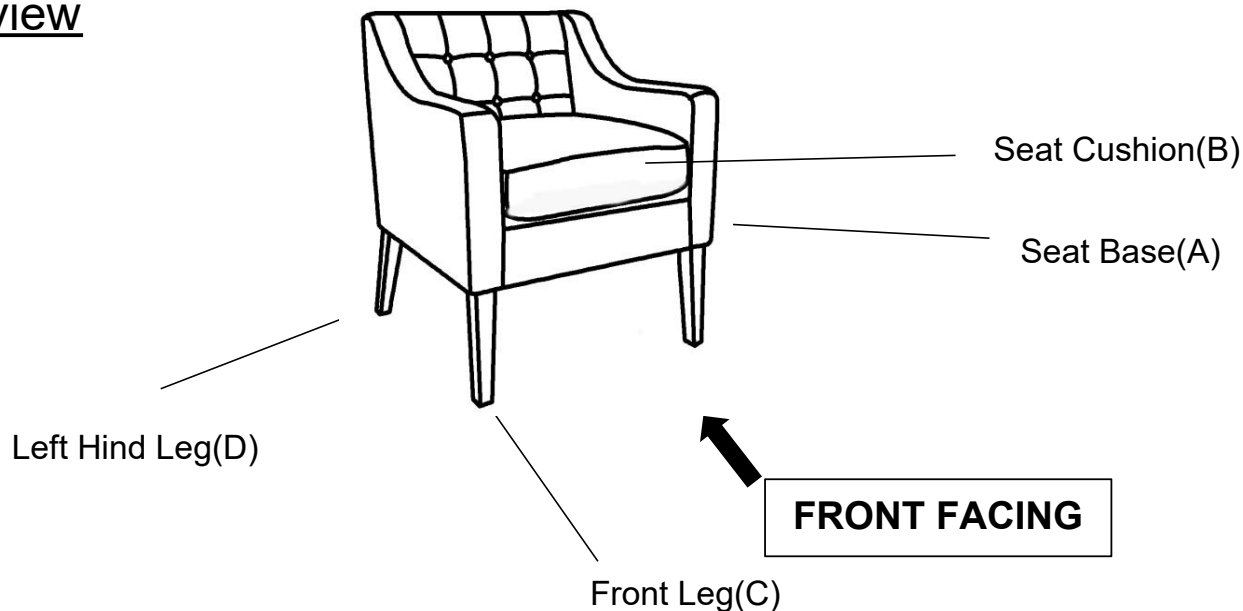

This Chair has multiple parts and may require about 30 minutes to assemble. To give you an overview of the Club Chair parts, the above picture is to help you put the various parts into perspective. Please read through the instructions below to familiarise yourself with the parts and steps before assembly.

## Step 1

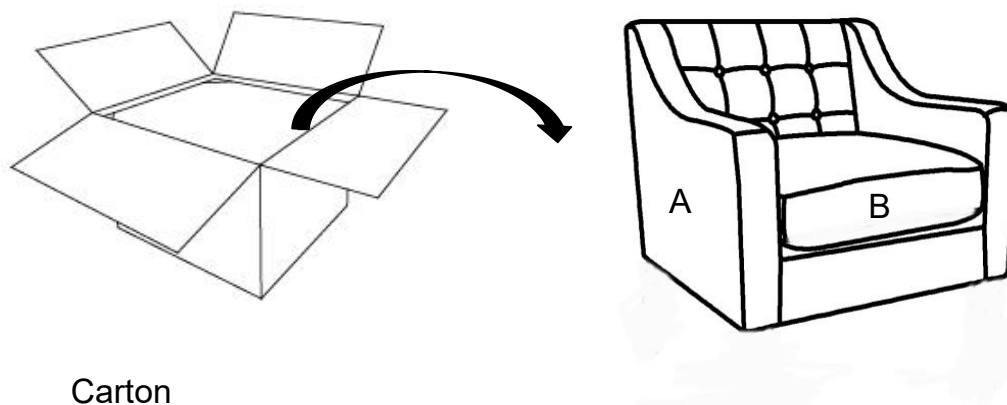

Take out the Seat Base(A) from the carton, place them on a clean, non-marring surface.

## Step 2

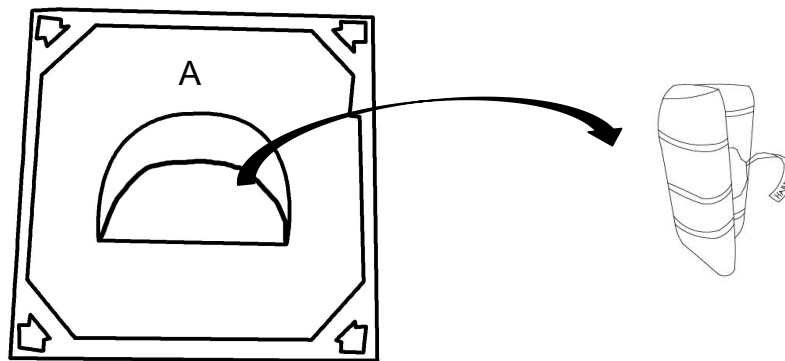

Put the Seat Base(A) upside down on carpet or a rug.  
Open the pouch with the zipper and take out the bag.  
Then close the pouch with the zipper.

## Step 3

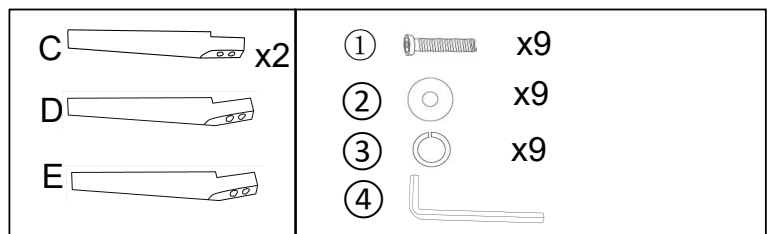
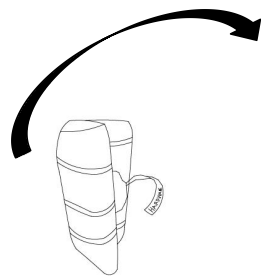

Open the Bag to take out the Front Leg(C), Left Hind Leg(D) ,Right Hind Leg(E) and the Hardware.

## Step 4

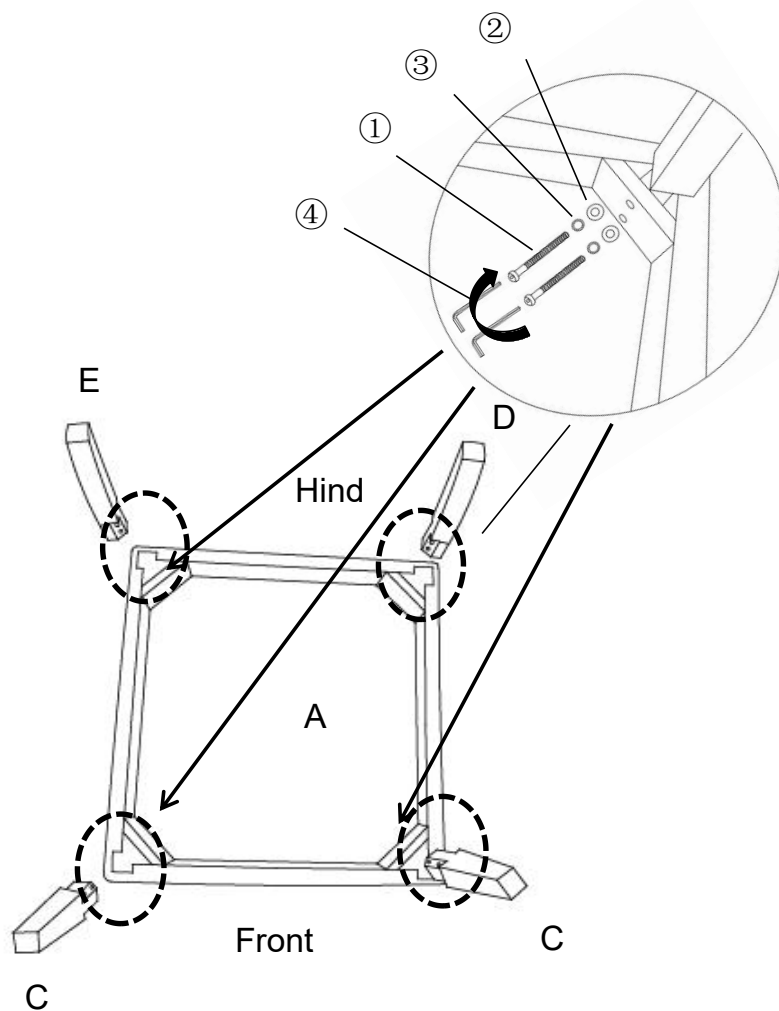

Install the Front Leg(C) at the bottom of the Seat Base(A) using Bolts(①), Spring Washers(③) and a Washer(②) with the Allen wrench(④) by hand. Repeat the same process to install the Left Hind Leg(D) and the Right Hind Leg(E). **Please don't tighten the Bolts(①) and just have them bolted half-way until all bolts are bolted in, then tighten all the Bolts(①) sequentially with the Allen wrench(④).**

Step 5

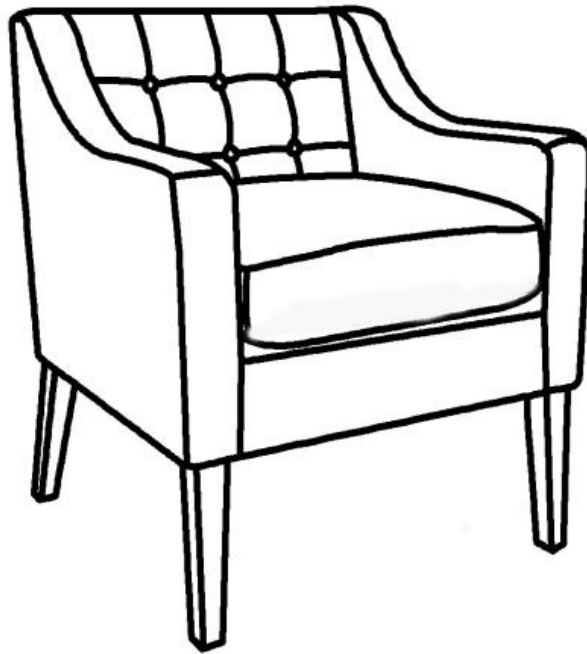

Make sure all of the parts connected to the right position are strong enough.

**Now your Chair is ready for use.**

**This Chair can only be used on a flat, level surface.**

## Care & Maintenance

	<ul style="list-style-type: none"> <li>Furniture may scratch floors. We recommend using furniture pads to protect your floors.</li> </ul>
	<ul style="list-style-type: none"> <li>Do not put hot items directly on furniture surface.</li> </ul>
	<ul style="list-style-type: none"> <li>Do not clean furniture with harsh cleansers or polish.</li> </ul>
	<ul style="list-style-type: none"> <li>Do not place furniture under direct sunlight.</li> </ul>
	<ul style="list-style-type: none"> <li>Do not place furniture near heating or cooling vents.</li> </ul>
	<ul style="list-style-type: none"> <li>Do not write on furniture without a padded barrier to protect the surface.</li> </ul>
	<ul style="list-style-type: none"> <li>Do not place furniture outside . For indoor use only.</li> </ul>
	<ul style="list-style-type: none"> <li>Not for commercial use. For residential use only.</li> </ul>
	<ul style="list-style-type: none"> <li>Stains may be removed with mild soap solution and damp cloth.</li> </ul>
	<ul style="list-style-type: none"> <li>Children should not climb or jump on the furniture.</li> </ul>
	<ul style="list-style-type: none"> <li>Dust and pick-up spills using a clean, non-colored, lint-free cloth.</li> </ul>

## Questions & Answers about Proposition 65

### • What is Proposition 65?

Proposition 65 requires businesses to provide warnings to Californians about significant exposures to chemicals that cause cancer, birth defects or other reproductive harm. These chemicals can be in the products that Californians purchase, in their homes or workplaces, or that are released into the environment. By requiring that this information be provided, Proposition 65 enables Californians to make informed decisions about their exposures to these chemicals.

Proposition 65 also prohibits California businesses from knowingly discharging significant amounts of listed chemicals into sources of drinking water.

Proposition 65 requires California to publish a list of chemicals known to cause cancer, birth defects or other reproductive harm. This list, which must be updated at least once a year, has grown to include approximately 900 chemicals since it was first published in 1987.

### • What types of chemicals are on the Proposition 65 list?

The list contains a wide range of naturally occurring and synthetic chemicals that include additives or ingredients in pesticides, common household products, food, drugs, dyes, or solvents. Listed chemicals may also be used in manufacturing and construction, or they may be byproducts of chemical processes, such as motor vehicle exhaust.

### • What does a warning mean?

If a warning is placed on a product label or posted or distributed at a workplace, a business, or in rental housing, the business issuing the warning is aware or believes that it is exposing individuals to one or more listed chemicals.

By law, a warning must be given for listed chemicals unless the exposure is low enough to pose no significant risk of cancer or is significantly below levels observed to cause birth defects or other reproductive harm.

### • Where can I get more information on Proposition 65?

If you have specific questions on the administration or implementation of Proposition 65, you can contact OEHHA's Proposition 65 program at [P65.Questions@oehha.ca.gov](mailto:P65.Questions@oehha.ca.gov), or by phone at (916) 445-6900.