

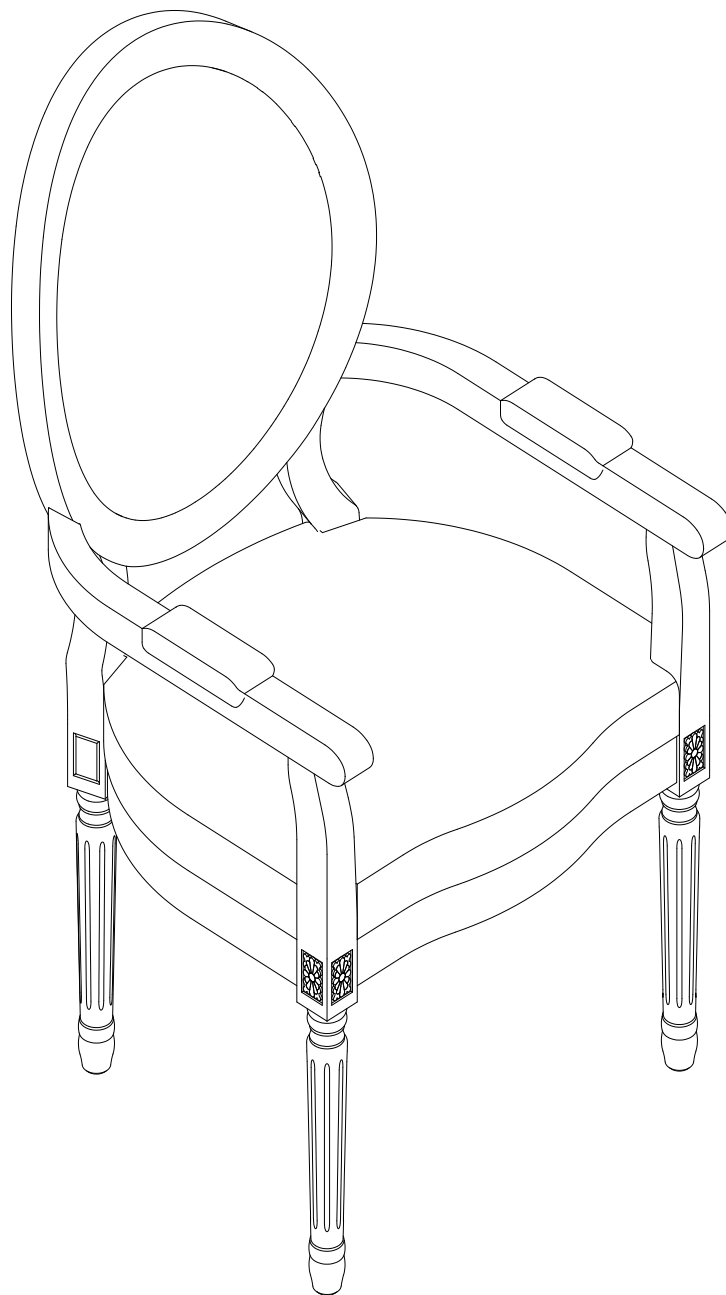

Assembly Instructions

Caution : You must read this before you proceed





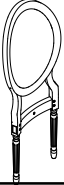
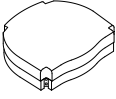



Dining Chair

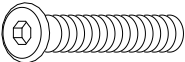
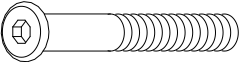
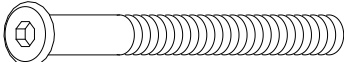

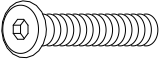
Parts List

Label	Picture	Description	QTY
A		Chair Back	1
B		Chair Seat	1
C		Left Leg & Arm	1
D		Right Leg & Arm	1

Hardware

Label	Picture	Description	QTY
①		Bolt (M8*45mm)	2
②		Bolt (M8*70mm)	5
③		Bolt (M8*80mm)	5
④		Spring Washer (M8)	11
⑤		Flat Washer (M8)	11
⑥		Bolt(M6*45mm)	3
⑦		Spring Washer(M6)	3
⑧		Flat Washer(M6)	3
⑨		5mm Allen Wrench	1
⑩		4mm Allen Wrench	1
⑪		Plug	2

Assembly Preparation

Before Beginning Assembly:

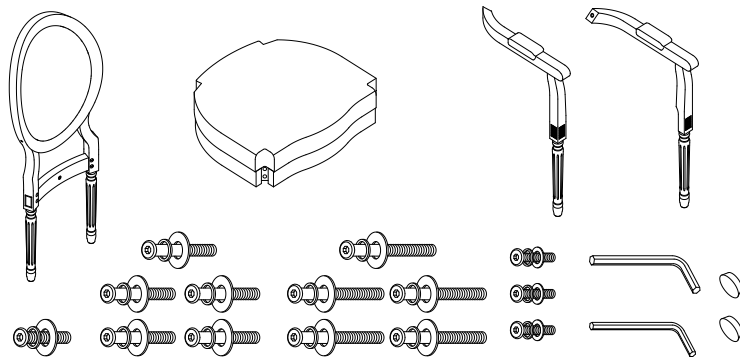

- Read instructions, cover to cover-



- Have 2 adults on hand for assembly-



- Do not assemble on flooring or carpet-



- Assemble on a clean non-marring surface (packing foam)-



- Save all packaging until finished-

Assembly Steps

Overview

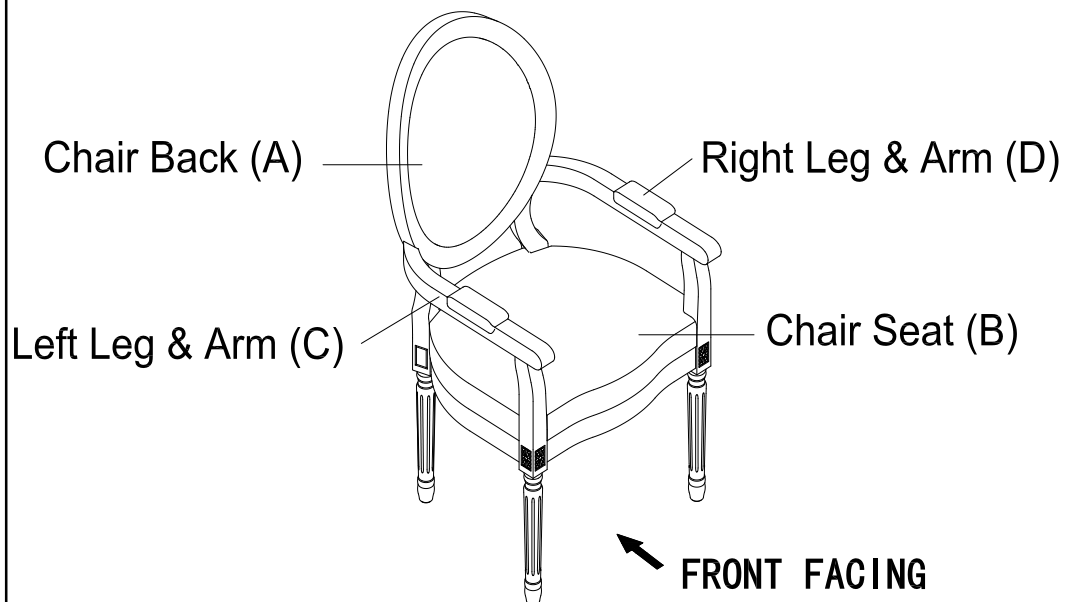

This Dining Chair has multiple parts and may require up to 30 minutes to assemble. To give you an overview of the Dining Chair parts, the above picture is to help you put the various parts into perspective. Please read through the instructions below to familiarise yourself with the parts and steps before assembly

Step 1

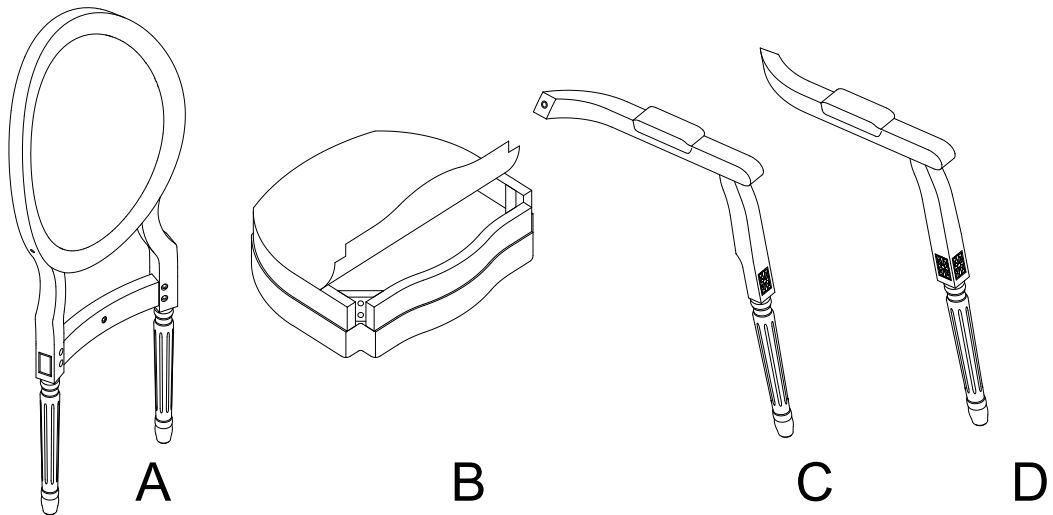

Place the Chair Back(A), the Chair Seat(B), the Left Chair Leg(C), the Right Chair Leg(D), onto a clean, non-marring surface

Step 2

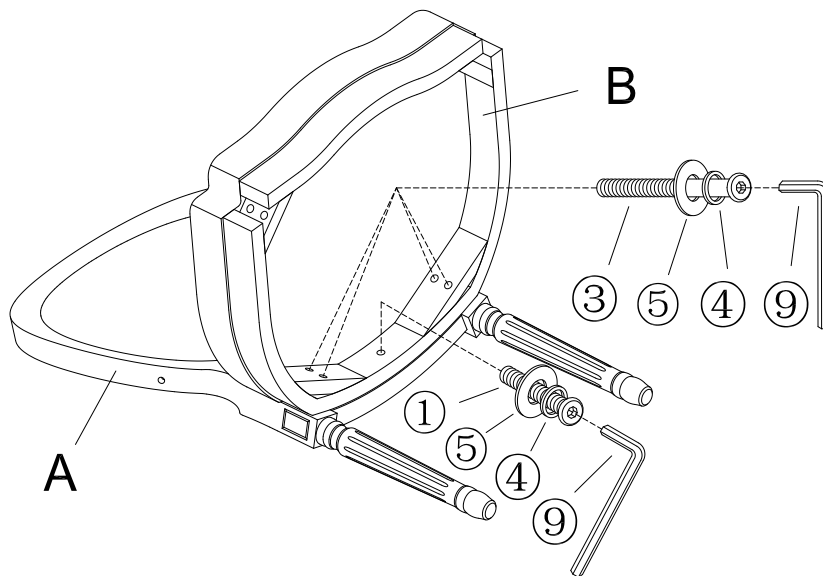

Place the Chair Back(A) on a clean, non-marring surface.

Align the mounting positions on the Seat(B) to the mountings on the Back with Legs(A).

Lock the middle mounting position, by using 1 Bolts 45mm ①+1 Spring Washers④ and 1 Flat Washers⑤ with Allen Wrench⑨.

Lock the corner four mounting positions and attach them using 4 Bolts 80mm③+4 Spring Washers④ +4 Flat Washers⑤ with Allen Wrench⑨, as shown on the picture above.

Friendly notice:

If the mounting positions cannot be aligned well which hinders the installation, then sway the Seat(B) lightly when locking the Bolts, this action could help avoid the Bolts getting stuck and ensure assemble smoothly.

Do not fully tighten the Bolts.

Step 3

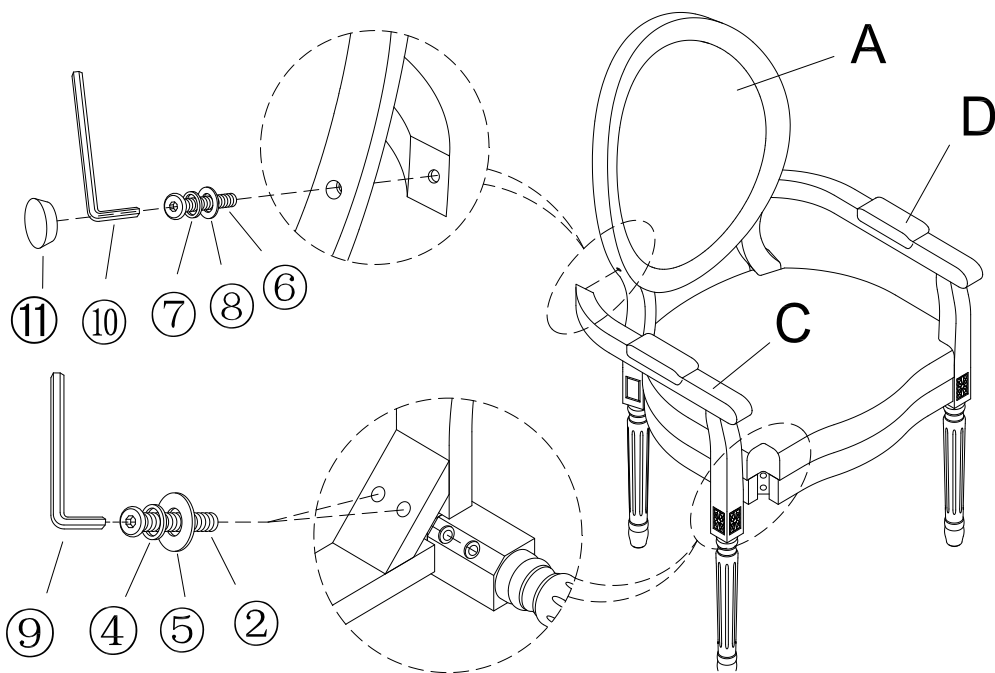

Position the Chair Back(A) as shown in the picture.

Align the mounting positions of the Leg & Arm(C&D) with the Chair Back(A)

Backrest position: 2 Bolt 45mm⑥ + 2 Spring Washer⑦+ 2 Flat Washer⑧ and the Allen Wrench⑩. Press the Plug⑪ into the position

Seat frame position: 4 Bolt 70mm②+ 4 Spring Washers④+ 4 Flat Washers⑤ and the Allen Wrench⑨.

Repeat the same process with the Right Arm(D).

Note: DO NOT fully tighten the Bolts

Step 4

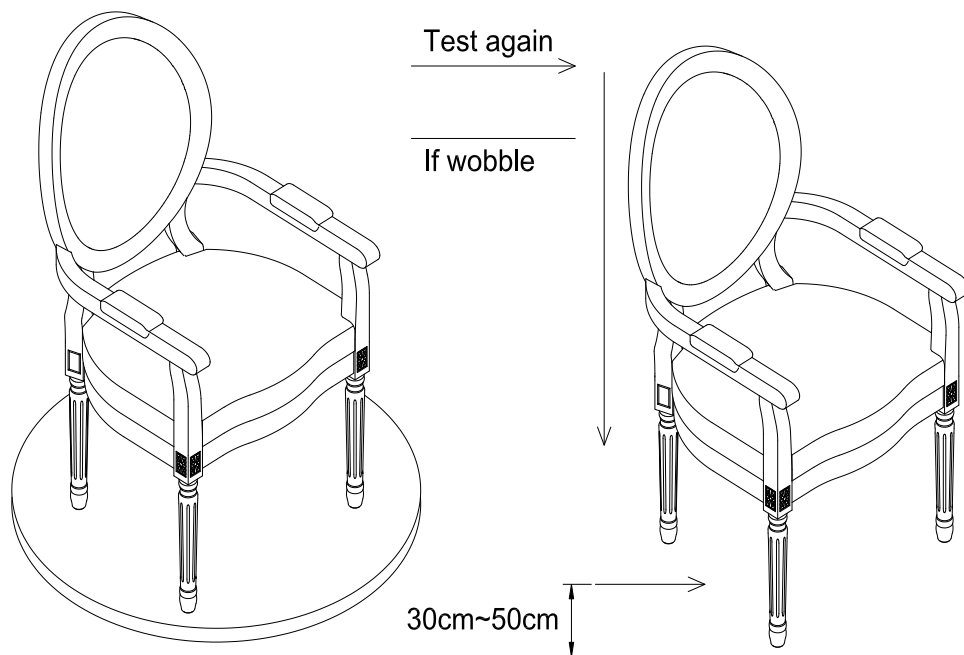

Place the Chair on a level Surface to check for wobbles.

If it wobbles, lift the Chair some 30cm to 50cm high from the ground.

Keep your feet and toes well away from the drop zone.

Drop Chair freely and vertically, with all four legs hitting the ground at the same time.

This Drop Test will help to ensure that all Bolts and gaps reach full alignment status.

Test again for evenness on a Level Surface.

If no wobbles are found, proceed to tighten all the Bolts.

When tightening the Bolts, tighten sequentially.

Do not fully tighten any Bolt fully and then move on towards the next one. This may cause the frame to warp.

If there is still wobbles, loosen the Bolts and execute this same drop test.

Step 5

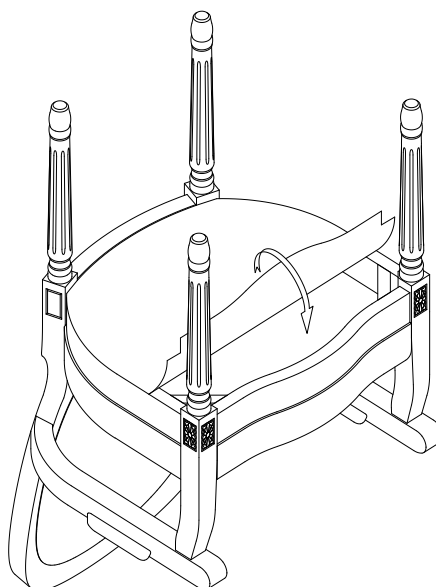





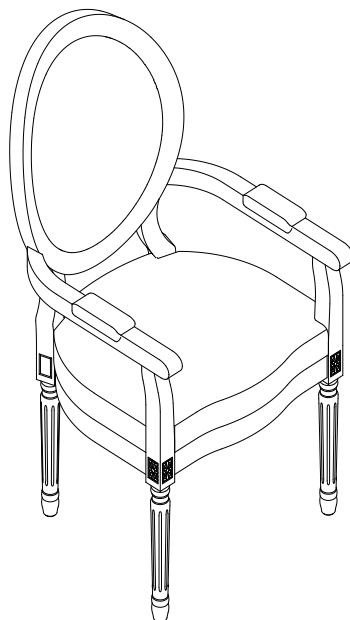





Place the Seat Base Cover back as shown in picture.
Smooth the Magic Tape down, Make sure all parts are connected and
securely locked into position.

Step 6



Your Chair is ready for use.
This Arm Chair can only be used on a flat, level surface.

Care & Maintenance

-  ● Furniture may scratch floors. We recommend using furniture pads to protect your floors.
 -  ● Do not put hot items directly on furniture surface.
 -  ● Do not clean furniture with harsh cleansers or polish.
 -  ● Do not place furniture under direct sunlight.
 -  ● Do not place furniture near heating or cooling vents.
 -  ● Do not write on furniture without a padded barrier to protect the surface.
 -  ● Do not place furniture outside . For indoor use only.
 -  ● Not for commercial use. For residential use only.
 -  ● Stains may be removed with mild soap solution and damp cloth.
 -  ● Children should not climb or jump on the furniture.
-
-  ● Dust and pick-up spills using a clean, non-colored, lint-free cloth.