

# Assembly Instructions

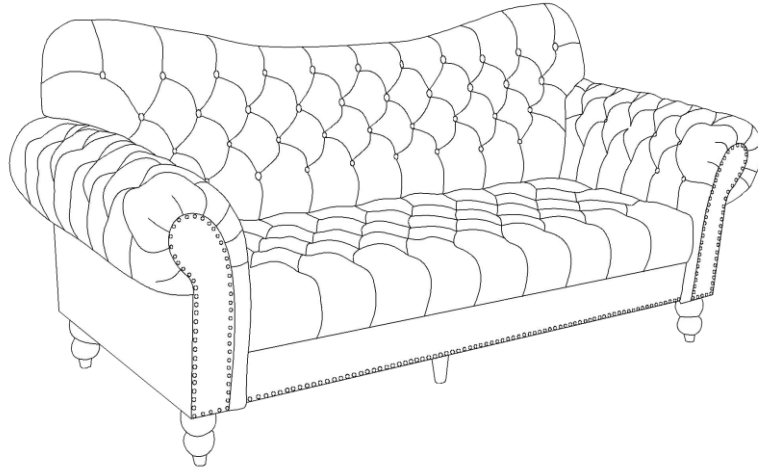

**Caution: You must read this before you proceed**

## Sofa





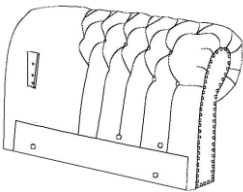

### Parts List

Label	Picture	Description	QTY(pc)
A		Backrest	1
B		Seat Base	1
C		Left Arm	1

D		Right Arm	1
E		Wooden Leg With 1 Plastic Gasket	4
F		Middle Leg with 1 Plastic Gasket	1





## Hardware List

Label	Picture	Description	QTY
①		Plastic Gasket	3
②		Allen Wrench	1
③		Spring Ring(Φ13mm)	11
④		Flat Big Washer(Φ30mm)	11
⑤		Bolt(M8*70mm)	11

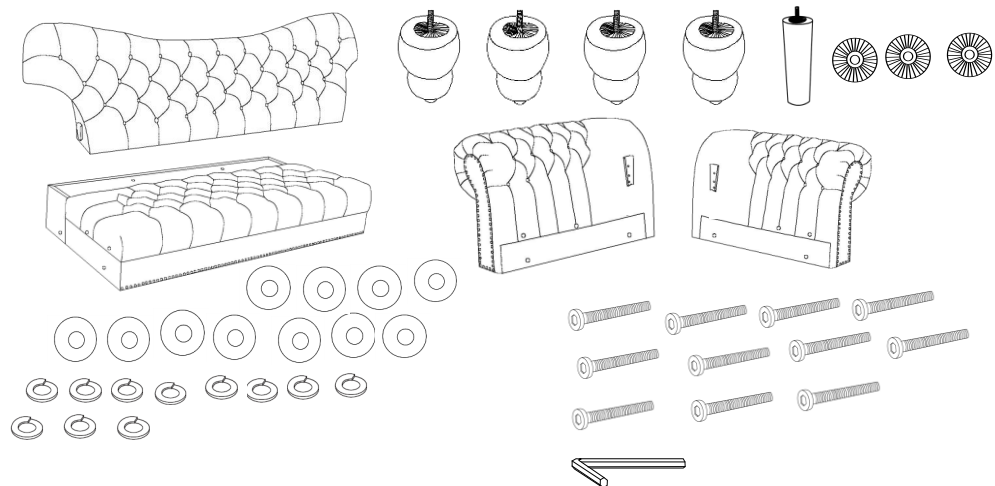
# Assembly Preparation

Before Beginning Assembly:



-  • Read instructions, cover to cover-
-  • Have 2 adults on hand for assembly-
-  • Do not assemble on flooring or carpet-
-  • Assemble on a clean non-marring surface (packing foam)-
-  • Save all packaging until finished-

# Assembly Steps

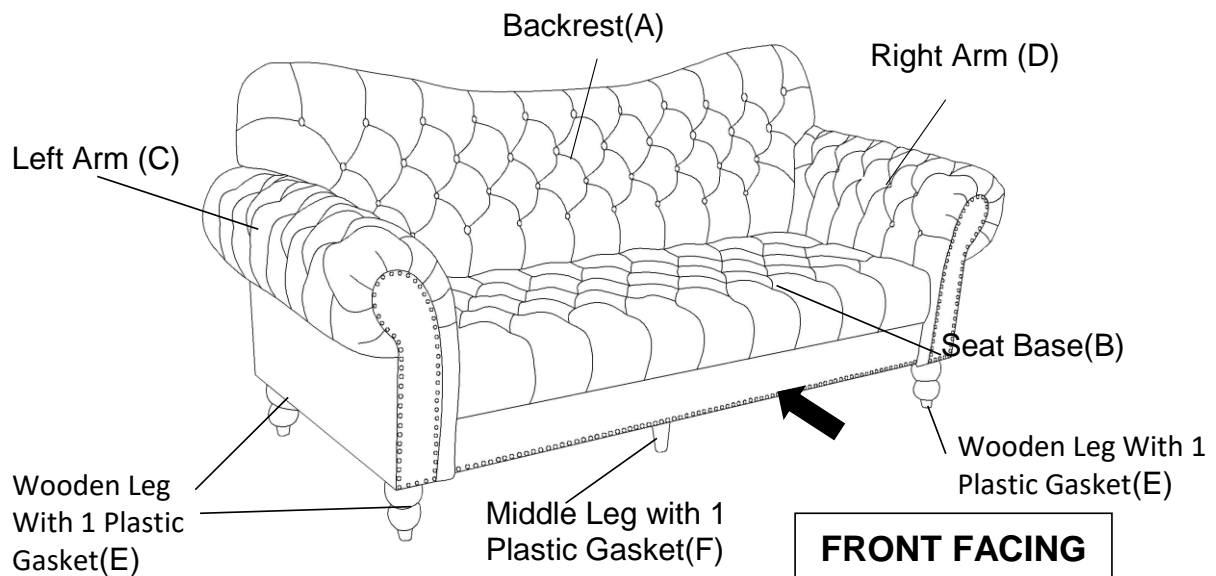

This Sofa has multiple parts and may require about 30 minutes to assemble. To give you an overview of the Sofa parts, the above picture is to help you put the various parts into perspective. Please read through the instructions below to familiarise yourself with the parts and steps before assembly.

**Step 1**

Carton "A"

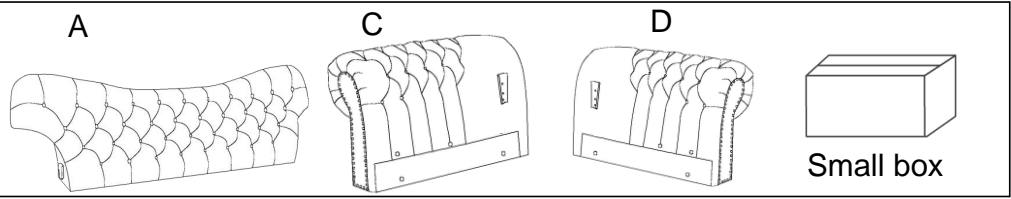
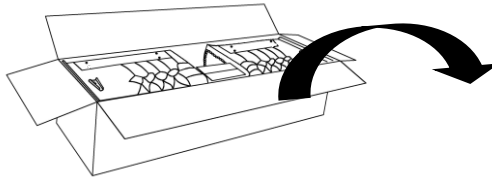

Take the Backrest(A), Left Arm(C),Right Arm(D) and Small Box out from the carton "A" and place them on a clean, non-marring surface.

**Step 2**

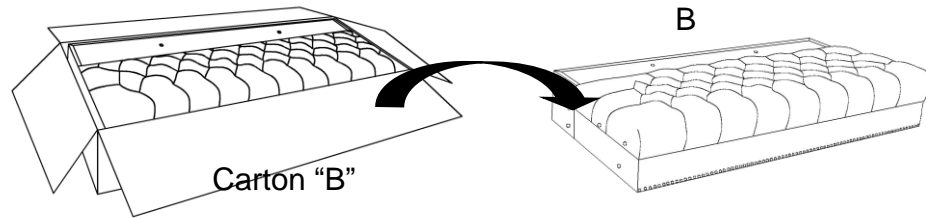

Take out the Seat Base(B) from the Carton "B", place it on a clean, non-marring surface.

**Step 3**

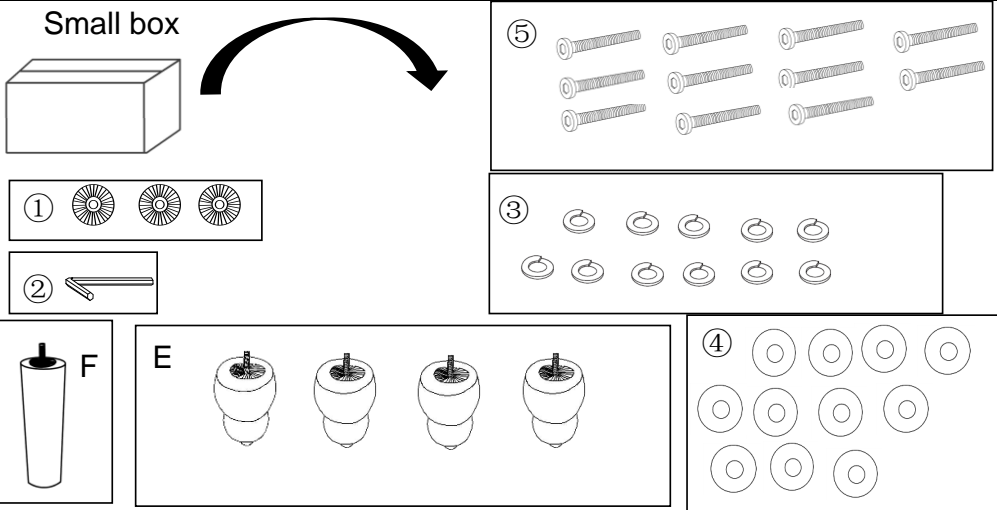

Open the Small Box to take out the Hardwares and Legs as listed above.

**Step 4**

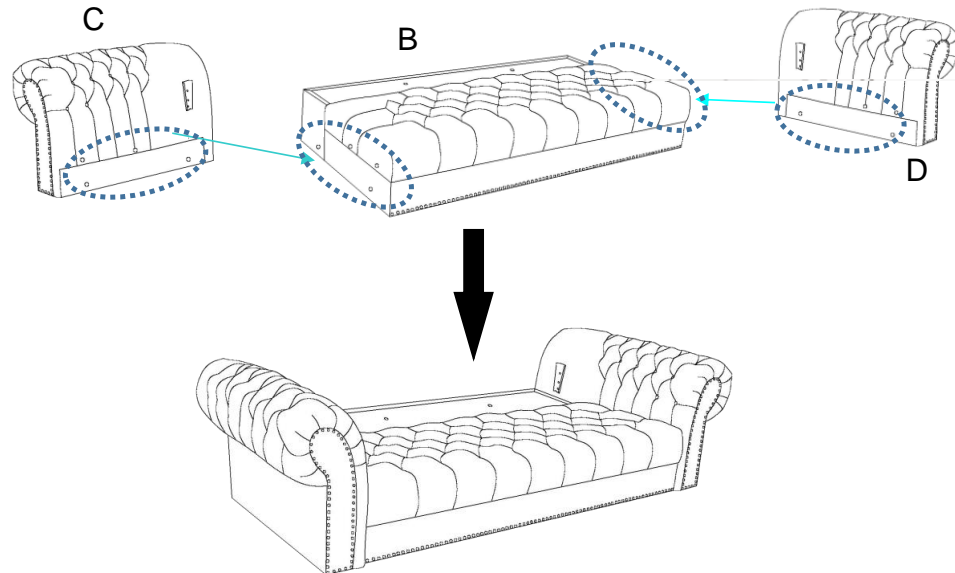

With assistance from your adult partner, put the Left Arm(C) and Right Arm(D) to the side of Seat Base(B) as pictured..

**Step 5**

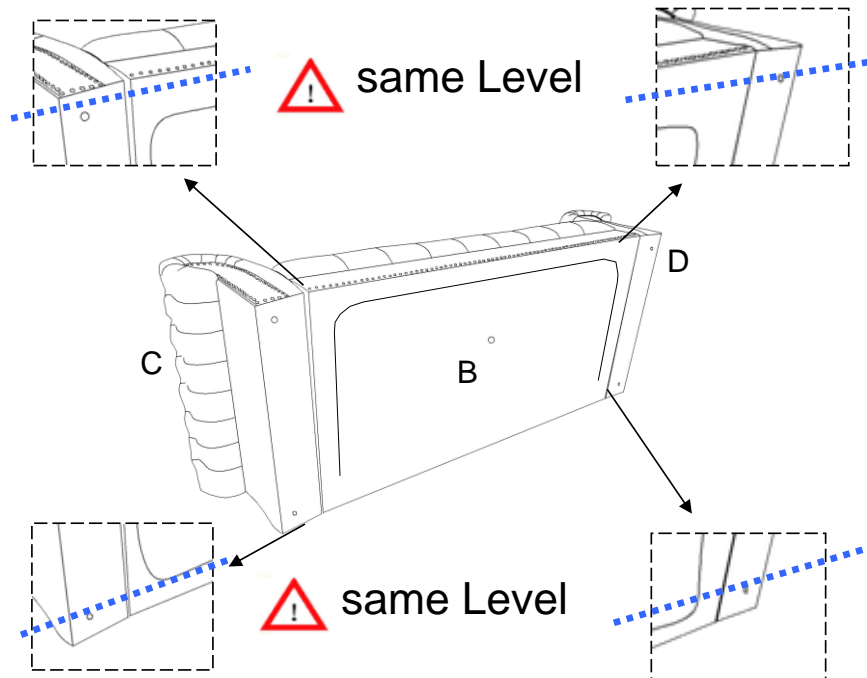

With assistance from your adult partner, turn over the Left Arm (C) ,make sure the bottom of Left Arm(C),Right Arm(D) and Seat Base(B) at the same Level as pictured

# Step 6

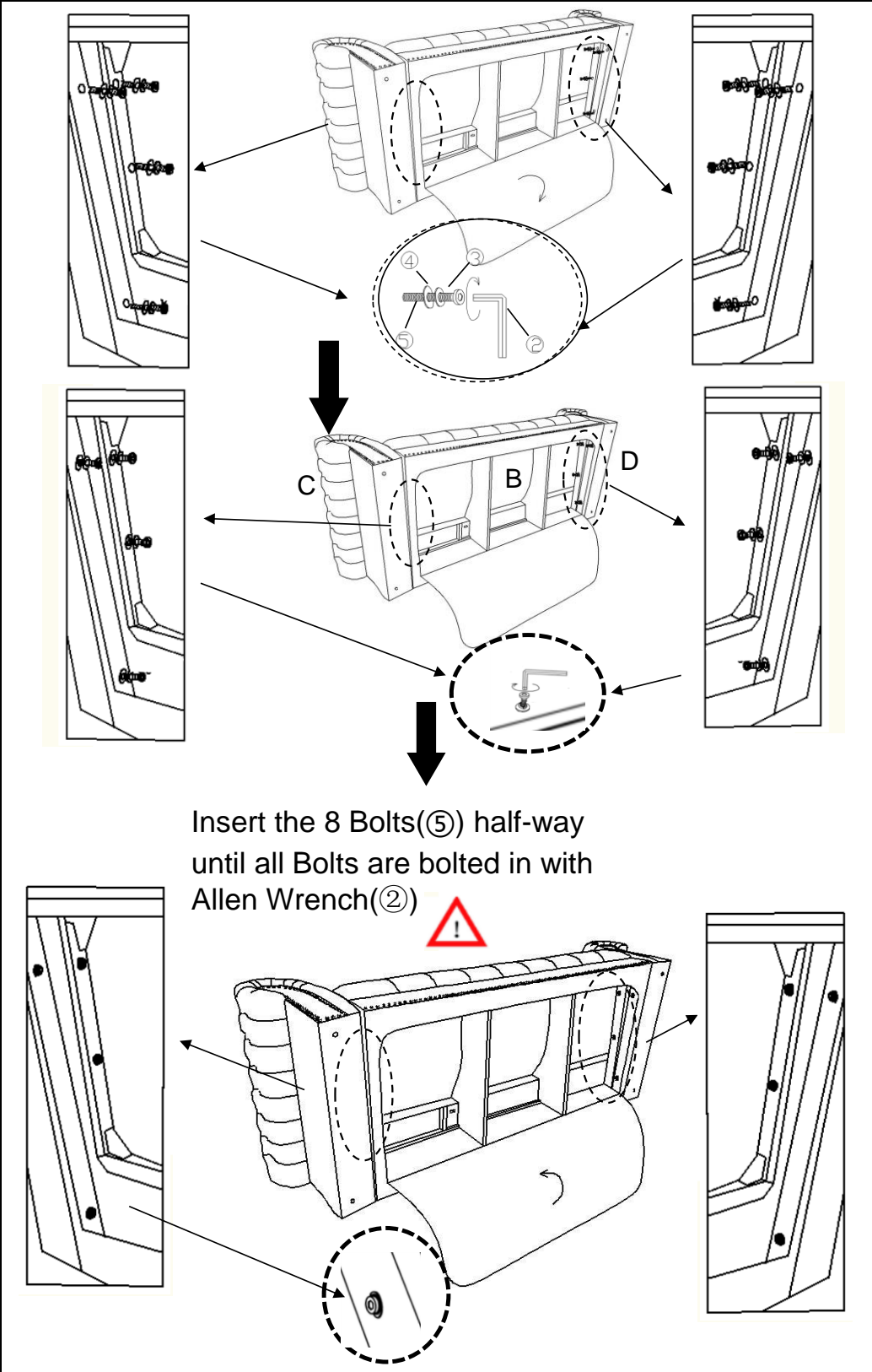

Unzip the non-woven cover under Seat Base(B).

Align the mounting position on the Left Arm(C) and Right Arm(D) to the mounting position of the Seat Base(B) as pictured, make sure the bottom of Both Arms, Backrest(A) and Seat Base(B) at the same level as mentioned in Step 5.

Using the Allen Wrench(Ⓣ) secure the Left Arm(C) and Right Arm(D) to the side of Seat Base(B) with Bolts(Ⓢ), Spring Ring(Ⓝ)and Flat Washers(Ⓞ).

Insert all the Bolts(Ⓢ) half-way starting one by one as pictured.

Then tighten the Bolts(Ⓢ) with the Allen Wrench(Ⓣ).

Then zip the non-woven fabric under the Seat Base(B).

## Step 7

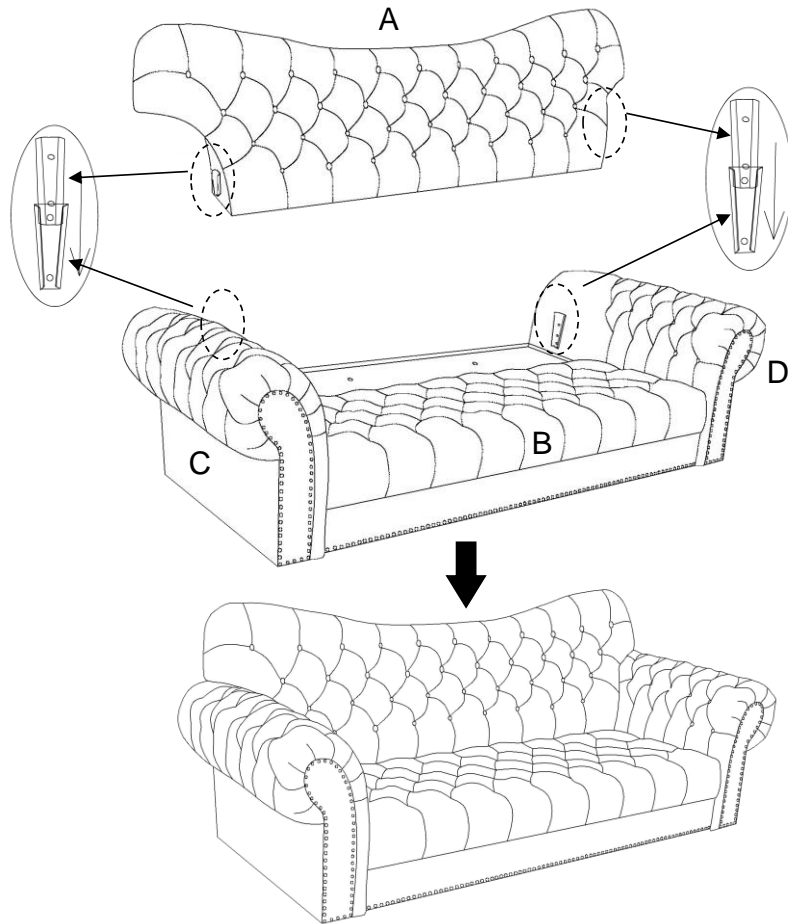

With assistance from your adult partner, align the mounting brackets on the Backrest(A) with those on the Left Arm(C) and Right Arm(D). Then slide the Backrest(A) downwards to make sure it locks into place as pictured. Please squeeze the armrests properly against the backrest to ensure that the inserts can be assembled smoothly.

### Step 8

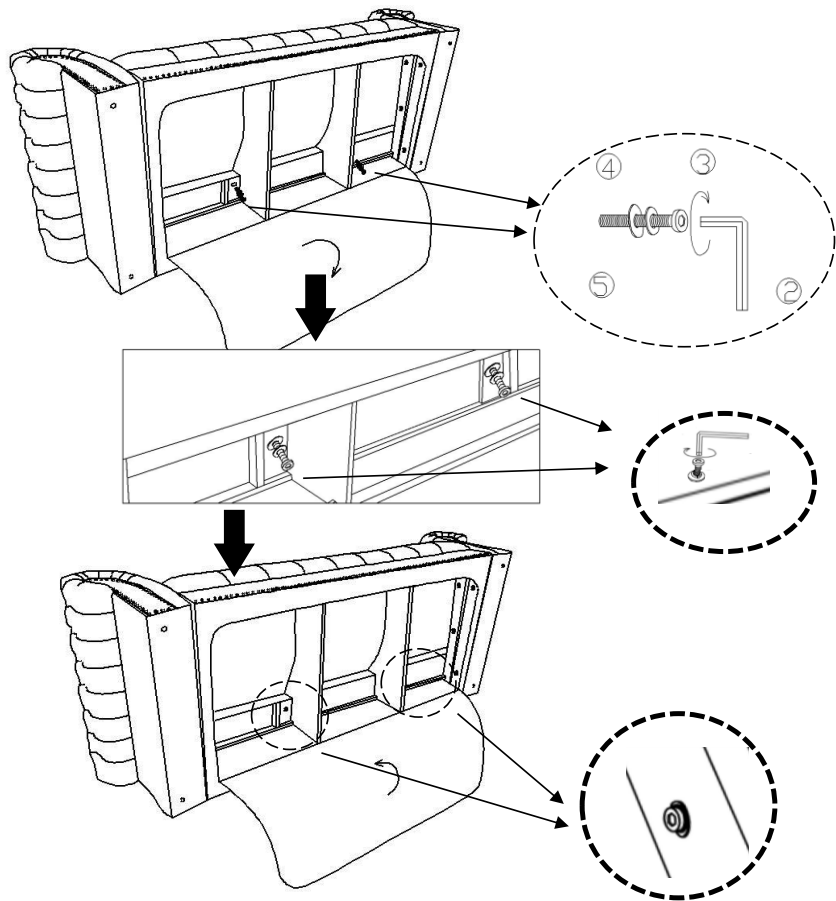

Carefully insert two Bolts(Ⓒ) into the two mounting positions on the hind-top of Seat Base(B). Using Allen Wrench(Ⓓ) to fix the Backrest(A) and Seat Base(B) together, then close the Non-woven fabric with MagicTape.



## Step 9

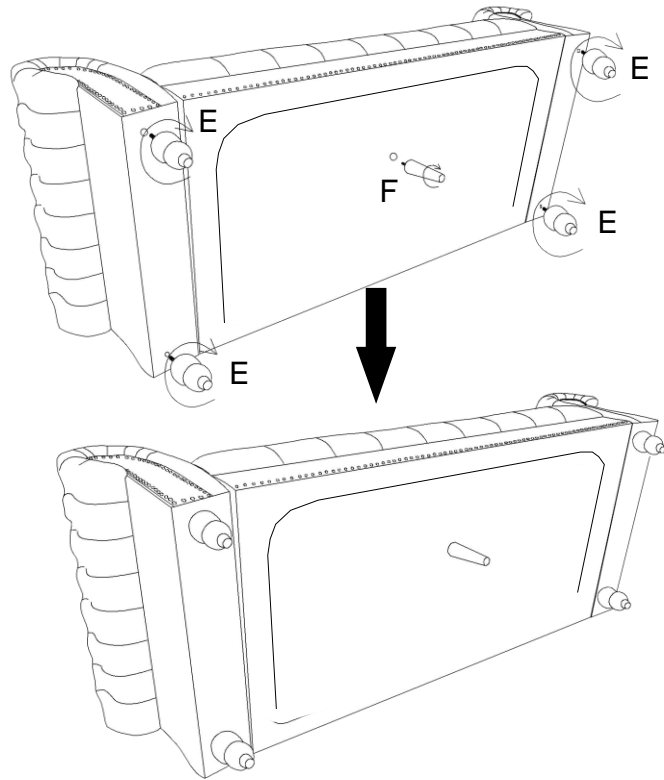



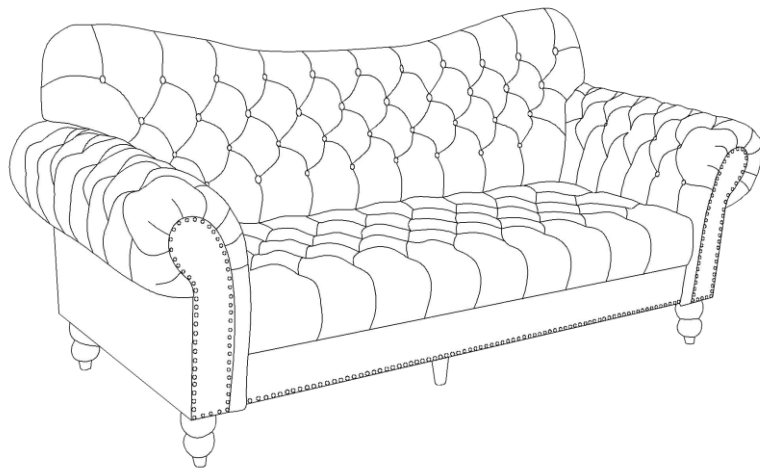

Carefully install the Wooden Leg With 1 Plastic Gasket(E) at the bottom of Left Arm(C) and Right arm(D) and Middle Leg with 1 Plastic Gasket(F) at the bottom of Seat Base(B).

## Step 10



Turn up the Sofa with assistance from your adult partner.  
Your Sofa is ready for use.  
This Sofa can only be used on a flat, level surface.

## Care & Maintenance

- |   |   |
|---|---|
|   | • Furniture may scratch floors. We recommend using furniture pads to protect your floors. |
|   | • Do not put hot items directly on furniture surface.                                     |
|   | • Do not clean furniture with harsh cleansers or polish.                                  |
|   | • Do not place furniture under direct sunlight.   |
|   | • Do not place furniture near heating or cooling vents.                                   |
|   | • Do not write on furniture without a padded barrier to protect the surface.              |
|   | • Do not place furniture outside . For indoor use only.                                   |
|   | • Not for commercial use. For residential use only.                                       |
|   | • Stains may be removed with mild soap solution and damp cloth.                           |
|   | • Children should not climb or jump on the furniture.                                     |
|   | • Dust and pick-up spills using a clean, non-colored, lint-free cloth.                    |

## Questions & Answers about Proposition 65

### • What is Proposition 65?

Proposition 65 requires businesses to provide warnings to Californians about significant exposures to chemicals that cause cancer, birth defects or other reproductive harm. These chemicals can be in the products that Californians purchase, in their homes or workplaces, or that are released into the environment. By requiring that this information be provided, Proposition 65 enables Californians to make informed decisions about their exposures to these chemicals. Proposition 65 also prohibits California businesses from knowingly discharging significant amounts of listed chemicals into sources of drinking water.

Proposition 65 requires California to publish a list of chemicals known to cause cancer, birth defects or other reproductive harm. This list, which must be updated at least once a year, has grown to include approximately 900 chemicals since it was first published in 1987.

### • What types of chemicals are on the Proposition 65 list?

The list contains a wide range of naturally occurring and synthetic chemicals that include additives or ingredients in pesticides, common household products, food, drugs, dyes, or solvents. Listed chemicals may also be used in manufacturing and construction, or they may be byproducts of chemical processes, such as motor vehicle exhaust.

### • What does a warning mean?

If a warning is placed on a product label or posted or distributed at a workplace, a business, or in rental housing, the business issuing the warning is aware or believes that it is exposing individuals to one or more listed chemicals.

By law, a warning must be given for listed chemicals unless the exposure is low enough to pose no significant risk of cancer or is significantly below levels observed to cause birth defects or other reproductive harm.

### • Where can I get more information on Proposition 65?

If you have specific questions on the administration or implementation of Proposition 65, you can contact OEHHA's Proposition 65 program at [P65.Questions@oehha.ca.gov](mailto:P65.Questions@oehha.ca.gov), or by phone at (916) 445-6900.