

# Assembly Instructions

Caution : You must read this before you proceed

## END TABLE

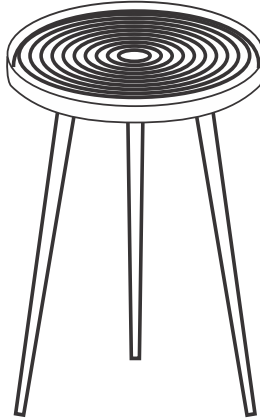

### Parts List

Label	Picture	Description	QTY
A	A line drawing of a single tapered leg, wider at the top and narrower at the bottom.	Leg	1
B	A line drawing of a single tapered leg, wider at the top and narrower at the bottom.	Leg	1
C	A line drawing of a single tapered leg, wider at the top and narrower at the bottom.	Leg	1
D	A line drawing of the circular table top with a spiral pattern.	Table Top	1

## Assembly Preparation

**Before Beginning  
Assembly:**

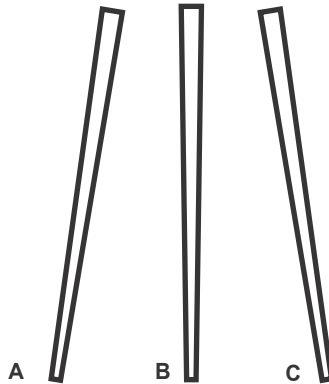
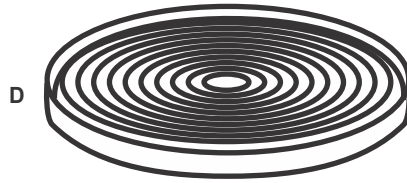

- Read instructions, cover to cover.



- Have 2 adults on hand for assembly.



- Do not assemble on flooring or carpet.



- Assemble on a clean non-marring surface (packing foam).



- Save all packaging until finished.

## Assembly Steps

### Overview

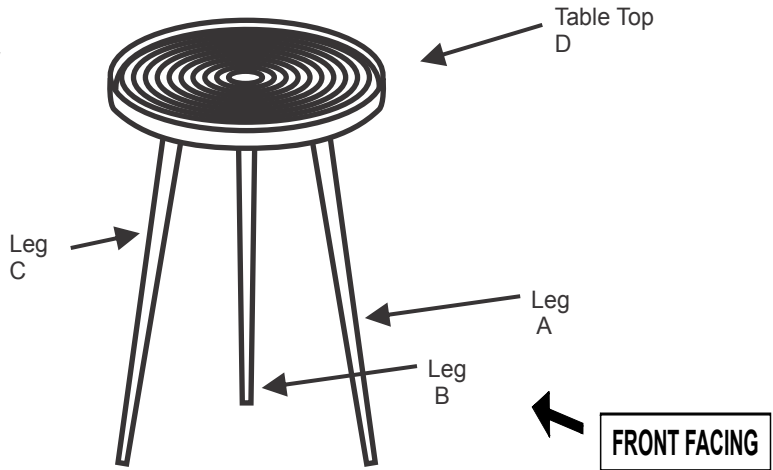

This End Table has multiple parts and may require up to some 30 minutes to assemble. To give you an overview of the table parts, the above picture is to help you put the various parts into perspective. Please read through the instructions below to familiarise yourself with the parts and steps before assembly.

### Step 1 :

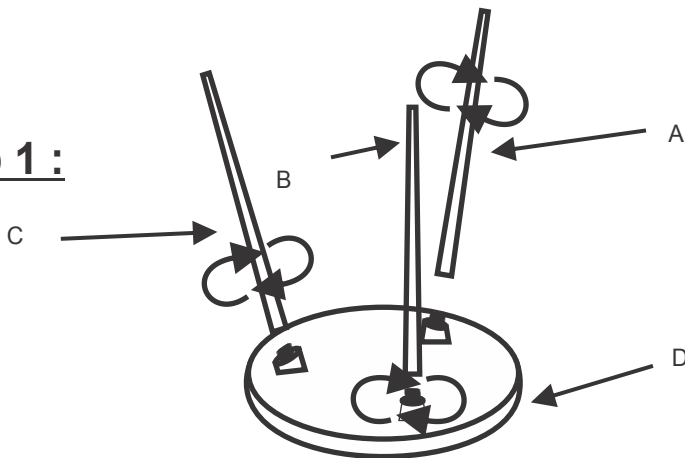

With assistance from your adult partner, place the Table Top (D) face down as picture, on clean, non-marring surface.

As shown in "Step 1" picture tighten the Leg (A) stud to slot given in Table top (D) in clockwise direction. Full tighten the Leg (A). Repeat the same process to assembly remaining Leg (B) & Leg (C).



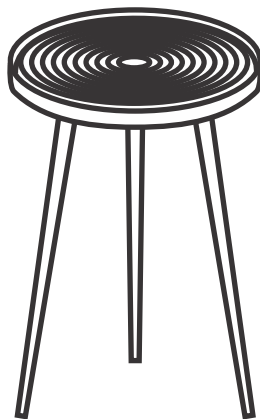
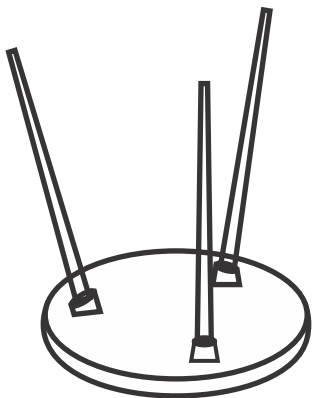







**Step 2 :**



Stand up the Table as picture shown  
This End Table is now ready to use.

**Caution: This End Table can only be used on flat, level surface.**

## Care & Maintenance

- ✓  ● Furniture may scratch floors. We recommend using furniture pads to protect your floors.
- ⊘  ● Do not put hot items directly on furniture surface.
- ⊘  ● Do not clean furniture with harsh cleanses or polish.
- ⊘  ● Do not place furniture under direct sunlight.
- ⊘  ● Do not place furniture near heating or cooling vents.
- ⊘  ● Do not write on furniture without a padded barrier to protect the surface.
- ⊘  ● Do not place furniture outside. For indoor use only.
- ⊘  ● Not for commercial use. For residential use only.
- ⊘  ● Stains may be removed with mild soap solution and damp cloth.
- ⊘  ● Children should not climb or jump on the furniture.

- ✓  ● Dust and pick-up spills using, non- colored, lint-free cloth.