





Assembly Instructions

Caution : You must read this before you proceed





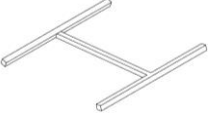

Bar Chair



Parts List

| Label | Picture | Description | QTY |
|-------|---|---|-----|
| A |  | Backrest | 1 |
| B |  | Chair Seat | 1 |
| C |  | Left Metal Tube(with pre-installed levers) | 1 |
| D |  | Right Metal Tube(with pre-installed levers) | 1 |
| E |  | Top Connecting Tube | 1 |
| F |  | Bottom Connecting Tube | 1 |

Hardware

| Label | Picture | Description | QTY |
|-------|---|----------------|-----|
| ① |  | Bolt (M6*14mm) | 11 |
| ② |  | Bolt (M6*32mm) | 5 |
| ③ |  | Bolt (M6*32mm) | 3 |
| ④ |  | Washer | 5 |
| ⑤ |  | Spring Washer | 5 |
| ⑥ |  | Allen Key | 1 |

Assembly Preparation

Before Beginning Assembly:



- Read instructions, cover to cover-



- Have 2 adults on hand for assembly-



- Do not assemble on flooring or carpet-



- Assemble on a clean non-marring surface (packing foam)-



- Save all packaging until finished-

Assembly Steps

Overview

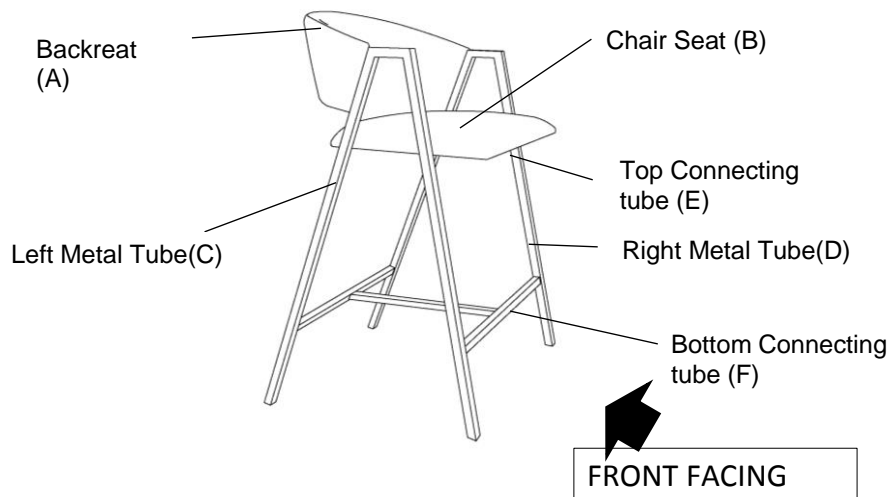

This **Bar Chair** has multiple parts and may require up to 30 minutes to assemble. To give you an overview of the **Bar Chair**, the above picture is to help you put the various parts into perspective. Please read through the instructions below to familiarise yourself with the parts and steps before assembly.

Step 1

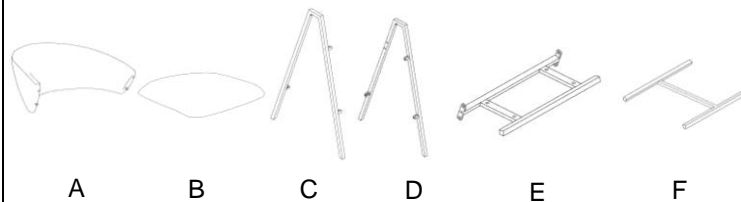

Place the Backrest(A), Chair Seat(B), **Left Metal Tube(with pre-installed levellers)** (C), **Right Metal Tube(with pre-installed levellers)**(D), Top Connecting Tube(E) and Bottom connecting Tube(F) on a clean, non-marring surface.

Step 2

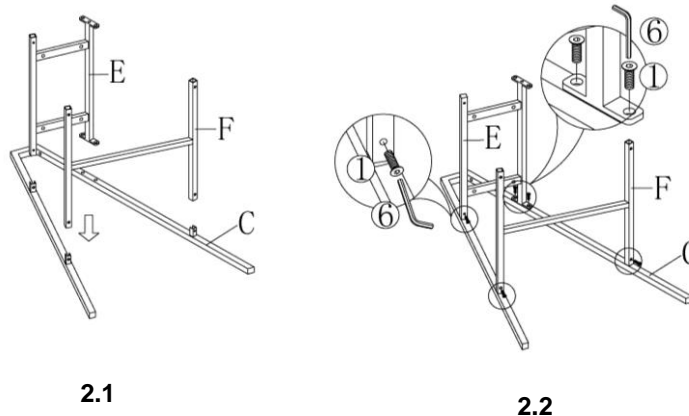

2.1) Insert the Top Connecting Tube(E) and Bottom connecting Tube(F) into Left Metal Tube(C) as pictured above.

2.2) Attach the Top Connecting Tube(E) and Bottom connecting Tube(F) to Left Metal Tube(C) using Bolts(①) with Allen Key(⑥).

Tighten the Bolts fully in a sequential manner.

Step 3

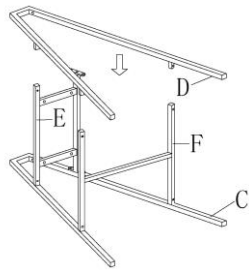

3.1

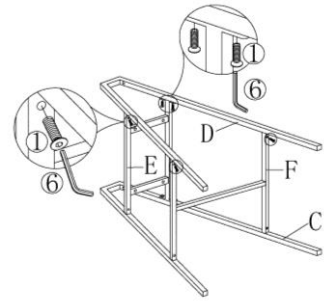

3.2

3.1) Insert the Right Metal Tube(D) into Top Connecting Tube(E) and Bottom connecting Tube(F) as pictures above.

3.2) Attach the Right Metal Tube(D) to Top Connecting Tube(E) and Bottom connecting Tube(F) using Bolts(①) with Allen Key(⑥).

Tighten the Bolts fully in a sequential manner.

Step 4

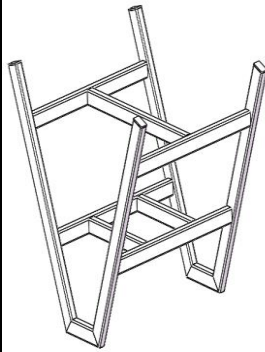

4.1

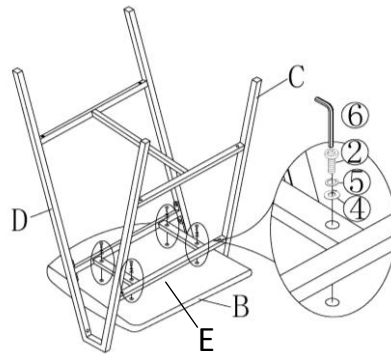



4.2

With the help from your partner, turn the Barchair frame bottom skyward, insert and attach the Seat (B) to Top connected Tube(E), using Bolt(②), Washer(④), Spring Washer(⑤) with Allen Key(⑥).

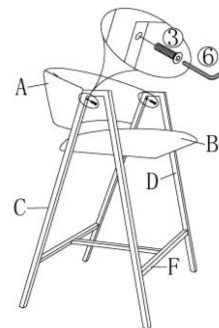
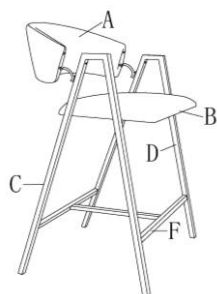



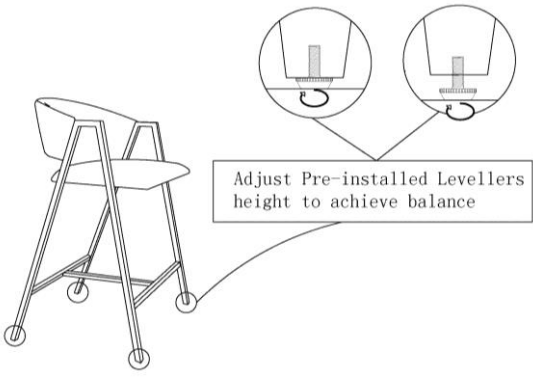





Step 5



Stand the Bar Chair and attach Backrest(A) to the Right Metal Tube (with pre-installed levellers)(D) and Left Metal Tube (with pre-installed levellers) (C) using Bolt(③) with Allen Key(⑥).

| | |
|--|--|
| <p>Step 6</p> |  <p>Adjust Pre-installed Levellers height to achieve balance</p> |
| <p>Adjust the Pre-installed Levellers at the bottom of the Backrest(A) to the Right Metal Tube(D) and Top Connecting Tube(E) until the Bar Chair is level with the ground.</p> | |
| <p>Step 7</p> |  |
| <p>Your Bar Chair ready for use. This Bar Chair can only be used on a flat, level surface.</p> | |

Care & Maintenance

-  ● Do not put hot items directly on furniture surface
 -  ● Do not clean furniture with harsh cleansers or polish.
 -  ● Do not place furniture under direct sunlight.
 -  ● Do not place furniture near heating or cooling vents.
 -  ● Do not write on furniture without a padded barrier to protect the surface.
 -  ● Do not place furniture outside . For indoor use only .
 -  ● Not for commercial use . For residential use only .
 -  ● Stains may be removed with mild soap solution and damp cloth.
 -  ● Children should not climb or jump on the furniture.
-
-  ● Dust and pick-up spills using a clean, non-colored, lint-free cloth .

Questions & Answers about Proposition 65

• What is Proposition 65?

Proposition 65 requires businesses to provide warnings to Californians about significant exposures to chemicals that cause cancer, birth defects or other reproductive harm. These chemicals can be in the products that Californians purchase, in their homes or workplaces, or that are released into the environment. By requiring that this information be provided, Proposition 65 enables Californians to make informed decisions about their exposures to these chemicals.

Proposition 65 also prohibits California businesses from knowingly discharging significant amounts of listed chemicals into sources of drinking water.

Proposition 65 requires California to publish a list of chemicals known to cause cancer, birth defects or other reproductive harm. This list, which must be updated at least once a year, has grown to include approximately 900 chemicals since it was first published in 1987.

• What types of chemicals are on the Proposition 65 list?

The list contains a wide range of naturally occurring and synthetic chemicals that include additives or ingredients in pesticides, common household products, food, drugs, dyes, or solvents. Listed chemicals may also be used in manufacturing and construction, or they may be byproducts of chemical processes, such as motor vehicle exhaust.

• What does a warning mean?

If a warning is placed on a product label or posted or distributed at a workplace, a business, or in rental housing, the business issuing the warning is aware or believes that it is exposing individuals to one or more listed chemicals.

By law, a warning must be given for listed chemicals unless the exposure is low enough to pose no significant risk of cancer or is significantly below levels observed to cause birth defects or other reproductive harm.

• Where can I get more information on Proposition 65?

If you have specific questions on the administration or implementation of Proposition 65, you can contact OEHHA's Proposition 65 program at P65.Questions@oehha.ca.gov, or by phone at (916) 445-6900.