

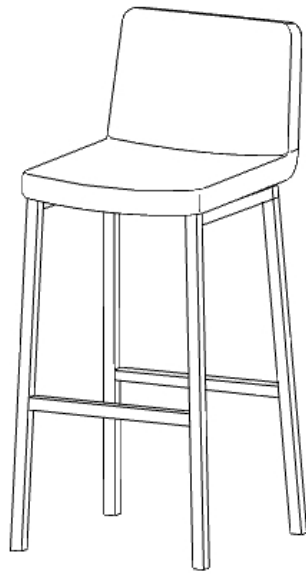

Assembly Instructions

Caution : You must read this before you proceed



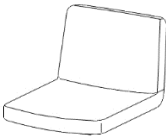

Barstool



Parts List

Label	Picture	Description	QTY
A		Seat	1
B		Frame	1





Hardware

Label	Picture	Description	QTY
①		Bolt (M6*30MM)	5
②		Washer	5
③		Spring Washer	5
④		Allen Key	1

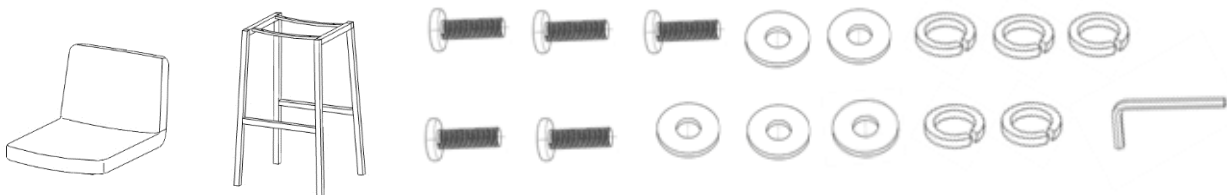
Assembly Preparation

Before Beginning Assembly:



-  • Read instructions, cover to cover-
-  • Have 2 adults on hand for assembly-
-  • Do not assemble on flooring or carpet-
-  • Assemble on a clean non-marring surface (packing foam)-
-  • Save all packaging until finished-

Assembly Steps

Overview

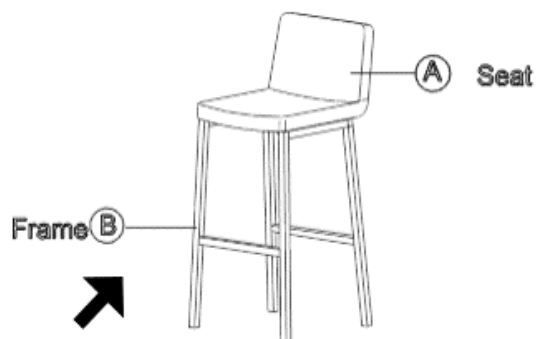

FRONT FACING

This Barstool has multiple parts and may require up to 30 minutes to assemble. To give you an overview of the Barstool parts, the above picture is to help you put the various Barstool parts into perspective. Please read through the instructions below to familiarise yourself with the parts and steps before assembly.

Step 1

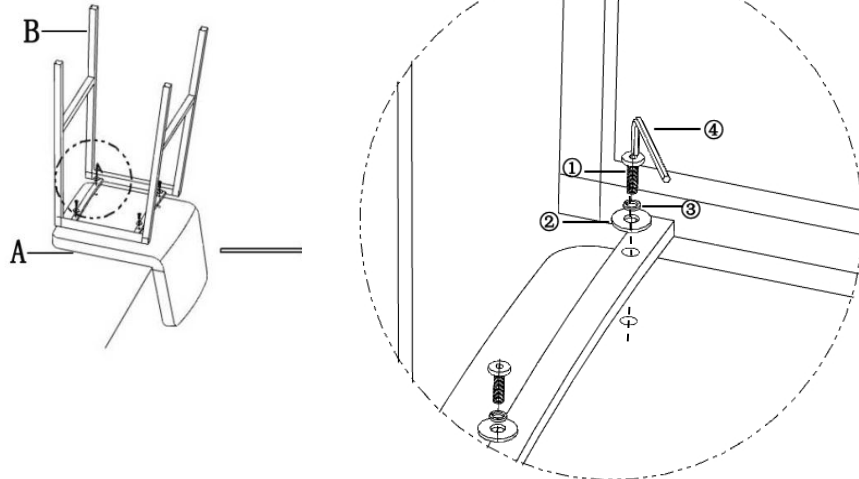

Place Seat(A) facedown on the edge of a table.
Align the mounting positions of the Frame(B) with the underside of the Seat(A).
Attach Seat(A) to Frame(B) using Bolts(1), Spring Washers(3), and Washers(2) with Allen Key(4).











Note: When tightening the Bolts, tighten sequentially. Do not tighten any Bolt fully and then move towards the next one. This could cause the frame to warp.

Step 2



Make sure all parts are connected and securely locked into position.
Your Barstool is ready for use.
This Barstool can only be used on a flat, level surface.

Care & Maintenance

-  Do not put hot items directly on furniture surface.
 -  Do not clean furniture with harsh cleansers or polish.
 -  Do not place furniture under direct sunlight.
 -  Do not place furniture near heating or cooling vents.
 -  Do not write on furniture without a padded barrier to protect the surface.
 -  Do not place furniture outside . For indoor use only .
 -  Not for commercial use. For residential use only .
 -  Stains may be removed with mild soap solution and damp cloth.
 -  Children should not climb or jump on the furniture.
-
-  Dust and pick-up spills using a clean, non-colored, lint-free cloth .