

FUJIAN ANXI SHANGQING HUAXING  
HANDICRAFT CO.,LTD

# TEST REPORT

**SCOPE OF WORK**

FCC TESTING—MODEL: N770P179928W

**REPORT NUMBER**

SZHH01918898-001

**ISSUE DATE**

Apr 29, 2024

**PAGES**

14

**DOCUMENT CONTROL NUMBER**

FCC SDoC\_b

© 2017 INTERTEK



**LABORATORY MEASUREMENTS****Pursuant To  
FCC Part 15: 2023 and ANSI C63.4: 2014**

**Applicant / Company:** FUJIAN ANXI SHANGQING HUAXING HANDICRAFT CO.,LTD  
WUDU INDUSTRIAL ZONE, ANXI COUNTY, FUJIAN PROVINCE, CHINA, 362400

**Equipment Under Test (EUT):**  
**Product Description:** Side Table  
**Model:** N770P179928W  
**Equipment Type:** Class B Device  
**Sample Receipt Date:** Apr 23, 2024  
**Test Conducted Date:** Apr 23, 2024 to Apr 29, 2024  
**Issue Date:** Apr 29, 2024  
**Test Site and Location:** Intertek Testing Services Shenzhen Ltd. Longhua Branch  
101, 201, Building B, No. 308 Wuhe Avenue,  
Zhangkengjing Community GuanHu Subdistrict, LongHua District, Shenzhen, People's Republic of China

**Conclusion:** The sample as received complied with the FCC Part 15 requirement.

**Prepared and Checked by:****Approved by:****Sign on File****Senior Engineer****Manager**

This report is for the exclusive use of Intertek's Client and is provided pursuant to the agreement between Intertek and its Client. Intertek's responsibility and liability are limited to the terms and conditions of the agreement. Intertek assumes no liability to any party, other than to the Client in accordance with the agreement, for any loss, expense or damage occasioned by the use of this report. Only the Client is authorized to permit copying or distribution of this report and then only in its entirety. Any use of the Intertek name or one of its marks for the sale or advertisement of the tested material, product or service must first be approved in writing by Intertek. The observations and test results in this report are relevant only to the sample tested. This report by itself does not imply that the material, product, or service is or has ever been under an Intertek certification program.



## TABLE OF CONTENTS

1	General Information.....	3
1.1	Client Information.....	3
1.2	General Description.....	3
1.3	Details of EUT.....	3
2	Test Summary.....	4
3	Test Specifications.....	5
3.1	Standards.....	5
3.2	Definition of Device Classification.....	5
3.3	EUT Operation Condition.....	5
4	Radiated Emission Measurements.....	6
4.1	Operating Environment.....	6
4.2	Test Setup and Procedure.....	6
4.3	Test Equipment.....	8
4.4	Radiated Emission Limits.....	8
4.5	Uncertainty of Radiated Emission.....	8
4.6	Radiated Emission Test Data.....	9
	Appendix A1: External Photo of EUT.....	11
	Appendix A2: Internal Photo of EUT.....	12
	Appendix B1: Radiated Emission Test Set-up.....	14

## 1. GENERAL INFORMATION

### 1.1 Client Information

Applicant: FUJIAN ANXI SHANGQING HUAXING HANDICRAFT CO.,LTD

### 1.2 General Description of EUT

Product Description: Side Table  
Model No.: N770P179928W  
Serial No.: Not Labelled

### 1.3 Details of EUT

Rated Voltage: N/A  
Battery Voltage: DC 3.2V (1 x 3.2V Rechargeable battery)  
Support Equipment: N/A  
Cables: N/A  
Adaptor: N/A

For more detail features, please refer to user's Manual.

## 2. TEST SUMMARY

Test	Standard	Class	Result
Radiated Emission	FCC Part 15 Section 15.109	Class B	Pass

Remark:

The EUT has been tested and passed the FCC Part 15.

Enclosed please find the FCC Labelling and Instruction Manual Requirements.

DRAFT

## 3. TEST SPECIFICATIONS

### 3.1 Standards

The radiated emission test was performed according to the procedures in ANSI C63.4: 2014. Test results are in compliance with the requirements of FCC Part 15: 2023. The EUT is battery operating device, the conducted emission is unnecessary. (DC)

The EUT setup configuration please refers to the photo of test configuration in item.

### 3.2 Definition of Device Classification

Unintentional radiator:

A device which is not intended to emit RF energy by radiation or induction.

Class A Digital Device:

A digital device which is marketed for use in commercial or business environment.

Class B Digital Device:

A digital device which is marketed for use by the general public or in a residential environment.

Note:

A manufacturer may also qualify a device intended to be marketed in a commercial, business or industrial environment as a Class B digital device, and in fact is encouraged to do so, provided the device complies with the technical specifications for a Class B Digital Device. In the event that a particular type of device has been found to repeatedly cause harmful interference to radio communications, the Commission may classify such a digital device as a Class B Digital Device, Regardless of its intended use.

### 3.3 EUT Operation Condition

The EUT was powered by DC 3.2V which can be charged by solar panel and was running in accordance with the manufacturer's operation manual.

## 4. RADIATED EMISSION MEASUREMENTS (FCC 15.109)

### 4.1 Operating Environment

Temperature:  $25^{\circ}\text{C} \pm 10^{\circ}\text{C}$

Test Voltage: DC 3.2V

### 4.2 Test Setup and Procedure

The figure below shows the test setup, which is utilized to make these measurements.

The frequency spectrum from 30MHz to 1000MHz was investigated.

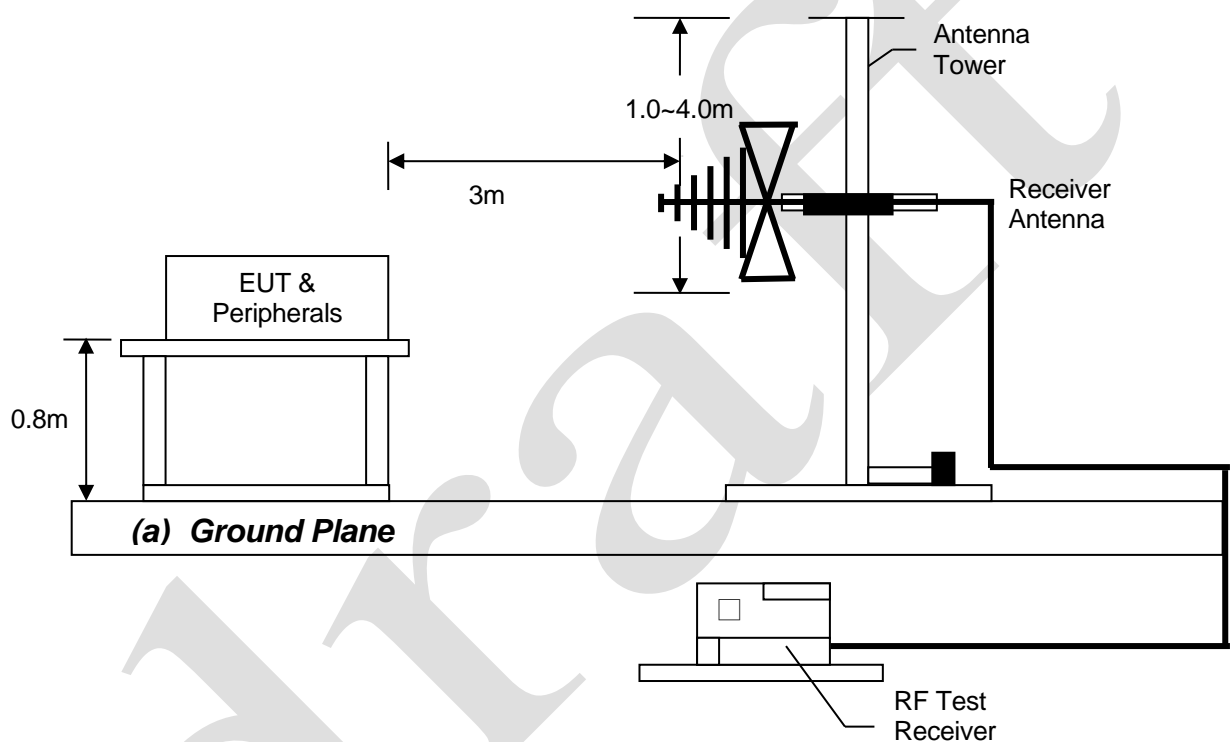

(Radiated Emission Measurements Test Setup for 30MHz to 1GHz)

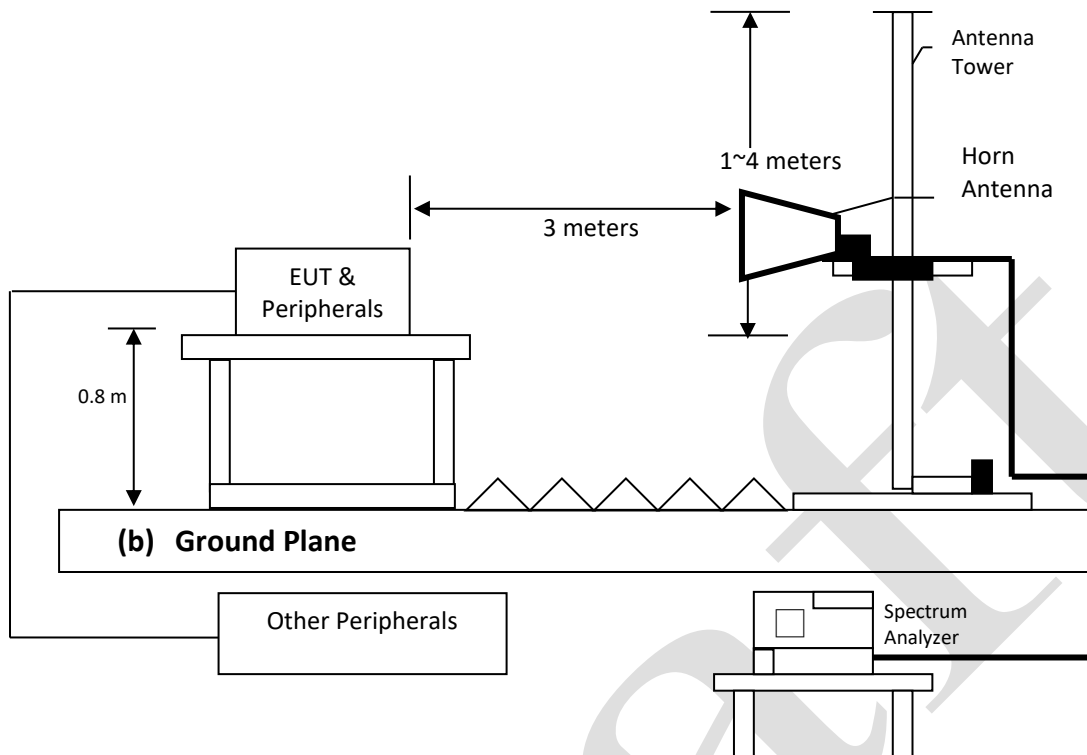

(Radiated Emission Measurements Test Setup for above 1GHz)

For tabletop equipment, the equipment under test was placed on the top of rotation table 0.8 meter above ground plane. For floor-standing equipment, the EUT and all cables were insulated, if required, from the ground plane by up to 12 mm of insulating material.

The table was 360 degrees to determine the position of the highest radiation.

EUT is set 3 meters from the EMI receiving antenna, which is mounted on a variable height mast. The antenna height is varied between one meter and four meters above ground to find the maximum value of the field strength. Both horizontal polarization and vertical polarization of the antenna are set to make the measurement. The bandwidth was setting on the EMI meter 120 kHz for 30MHz to 1GHz, The bandwidth was setting on the Spectrum Analyzer 1MHz for above 1GHz.

The levels are quasi peak value readings for the frequency spectrum from 30MHz to 1000MHz was investigated.

The levels are peak, average value readings for the frequency spectrum from 1GHz to 6GHz was investigated.



### 4.3 Test Equipment

Equip No.	Description	Manufacturer	Model No.	Cal. Date	Due Date
SZ185-04	EMI Receiver	R & S	ESR7	Nov 10, 2023	Nov 10, 2024
SZ061-03	Biconilog Antenna	ETS	3142E	Jul 7, 2021	Jul 7, 2024
SZ188-01	Anechoic Chamber	ETS	FACT 3-2.0	Dec 12, 2021	Dec 12, 2024

### 4.4 Radiated Emission Limits

According to FCC 15.109, except for Class A digital device, the field strength of radiated emission from unintentional radiators at a distance of 3 meters shall not exceed the following values:

Class B Radiated Emission Limits:

Frequency MHz	Field Strength dB $\mu$ V/m
30-88	40.0
88-216	43.5
216-960	46.0
Above 960	54.0

### 4.5 Uncertainty of Radiated Emission

When determining the test conclusion, the Measurement Uncertainty of test has been considered. The measurement uncertainty is 4.8dB at a level of confidence of 95%.

### 4.6 Radiated Emission Test Data

The graphic and data table consisting of the worst-case testing result were attached in the following pages.

Applicant: FUJIAN ANXI SHANGQING HUAXING HANDICRAFT CO.,LTD

Worst Case Operating Mode: Light

Model: N770P179928W

## Graphic / Data Table

### Radiated Scan Pursuant to FCC 15.109: Emissions Requirement

#### Horizontal

FCC Part 15

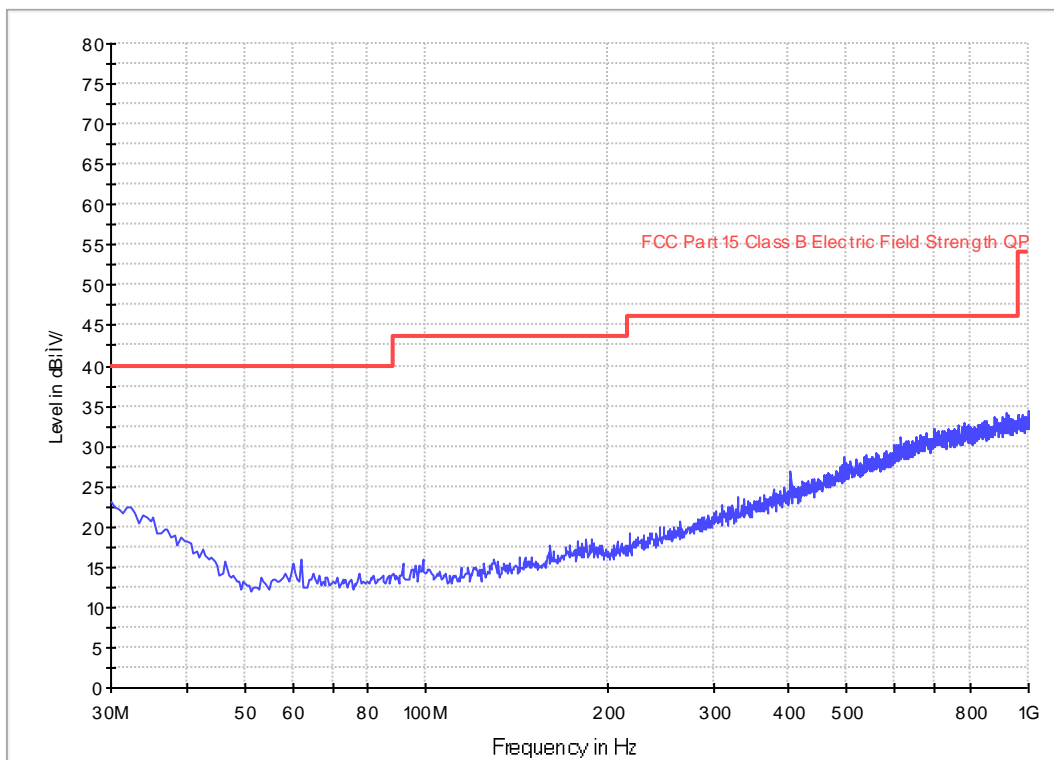

Remark: The emissions were very low against the limit in the frequency range 30MHz-1000MHz.

Applicant: FUJIAN ANXI SHANGQING HUAXING HANDICRAFT CO.,LTD

Worst Case Operating Mode: Light

Model: N770P179928W

### Graphic / Data Table

#### Radiated Scan Pursuant to FCC 15.109: Emissions Requirement

#### Vertical

FCC Part 15

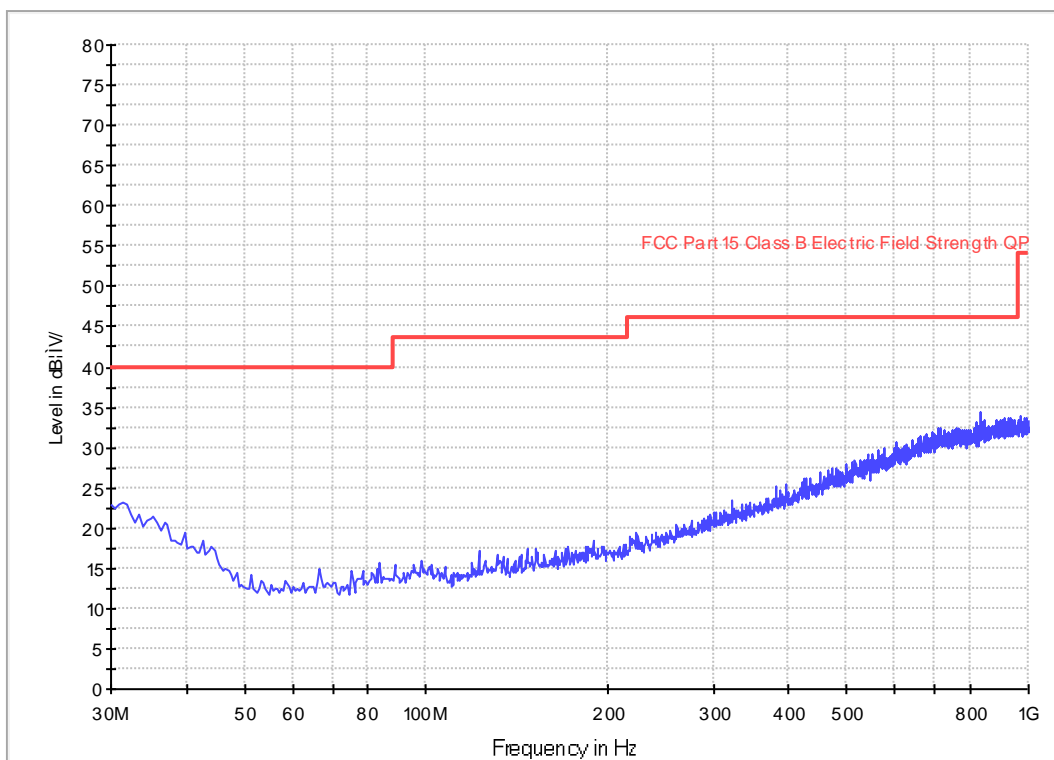

Remark: The emissions were very low against the limit in the frequency range 30MHz-1000MHz.

**APPENDIX A1: EXTERNAL PHOTO OF EUT**

External Photo



External Photo

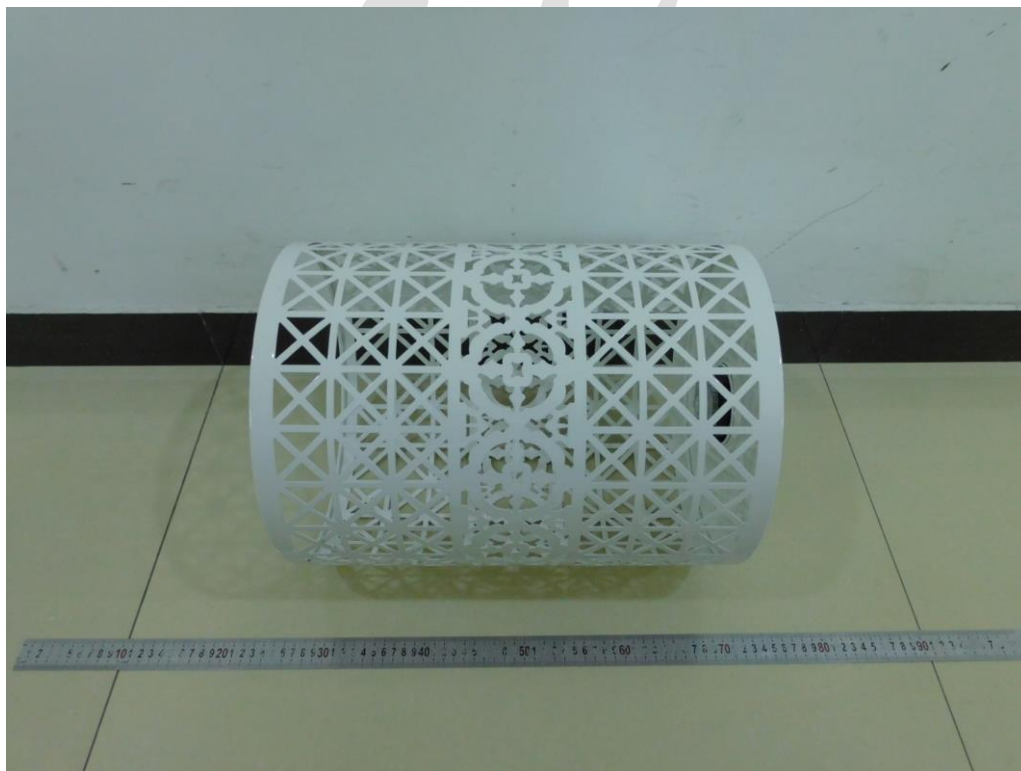

## APPENDIX A2: INTERNAL PHOTO OF EUT

Internal Photo

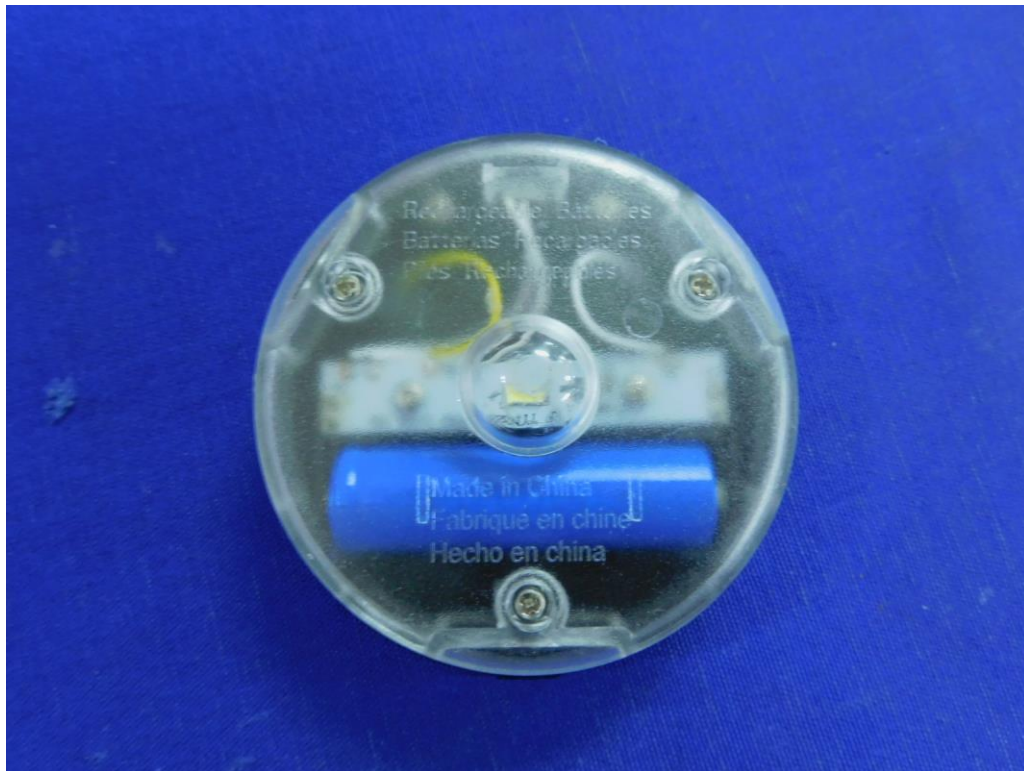

Internal Photo

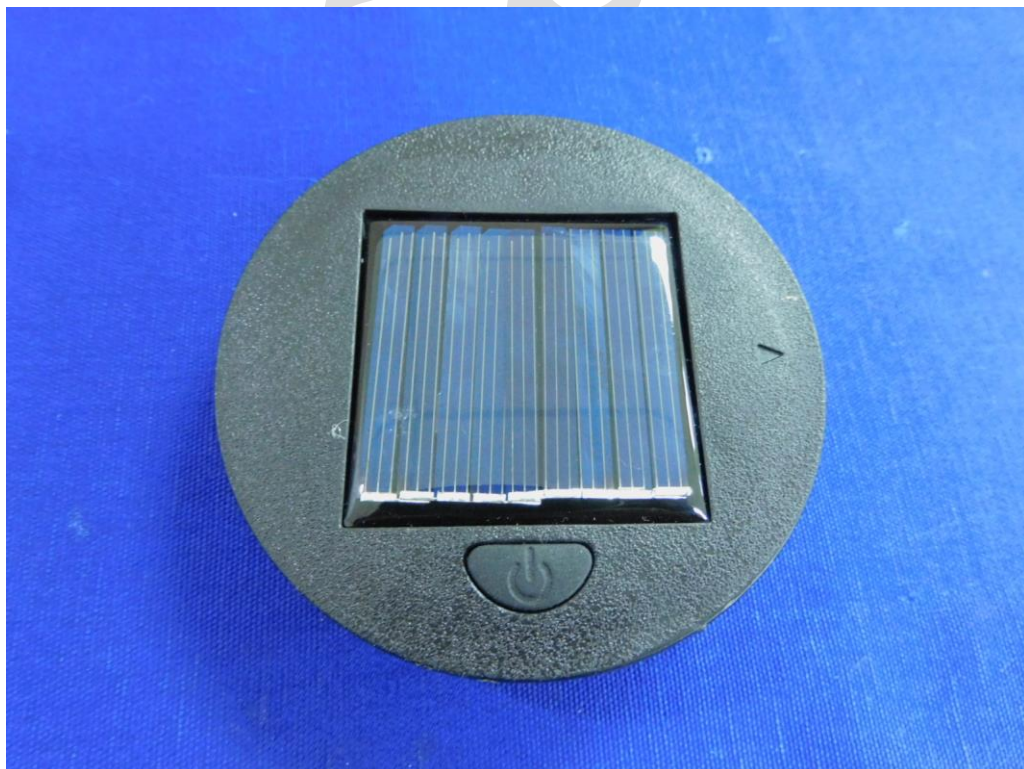

## APPENDIX A2: INTERNAL PHOTO OF EUT

Internal Photo

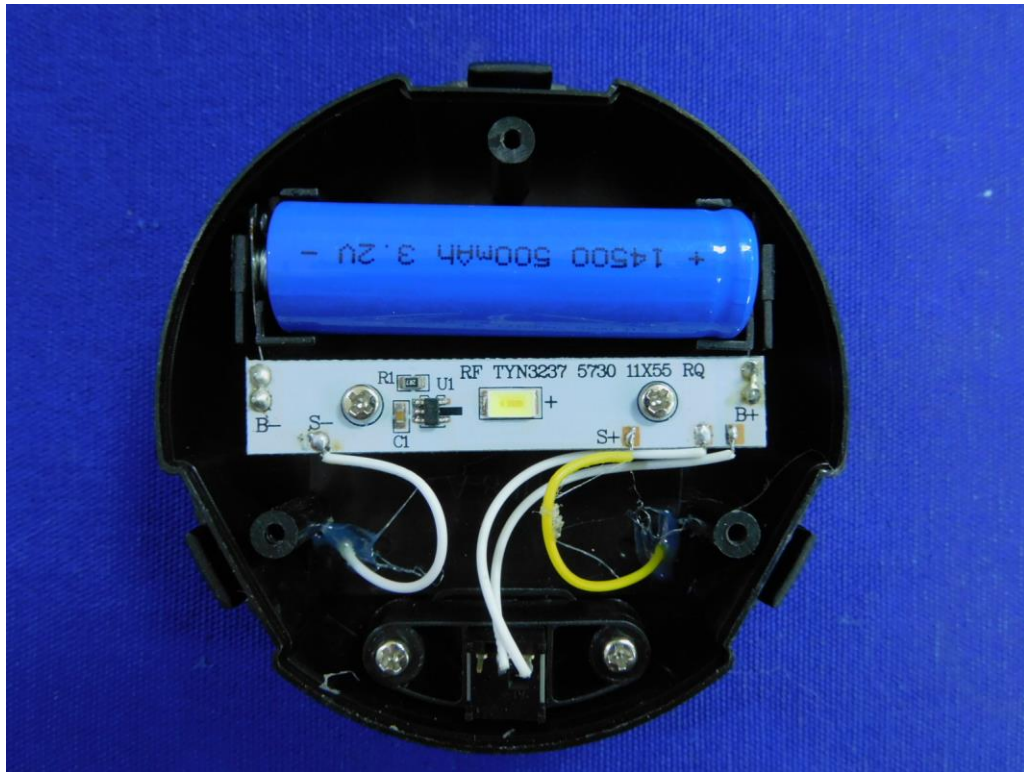

Internal Photo

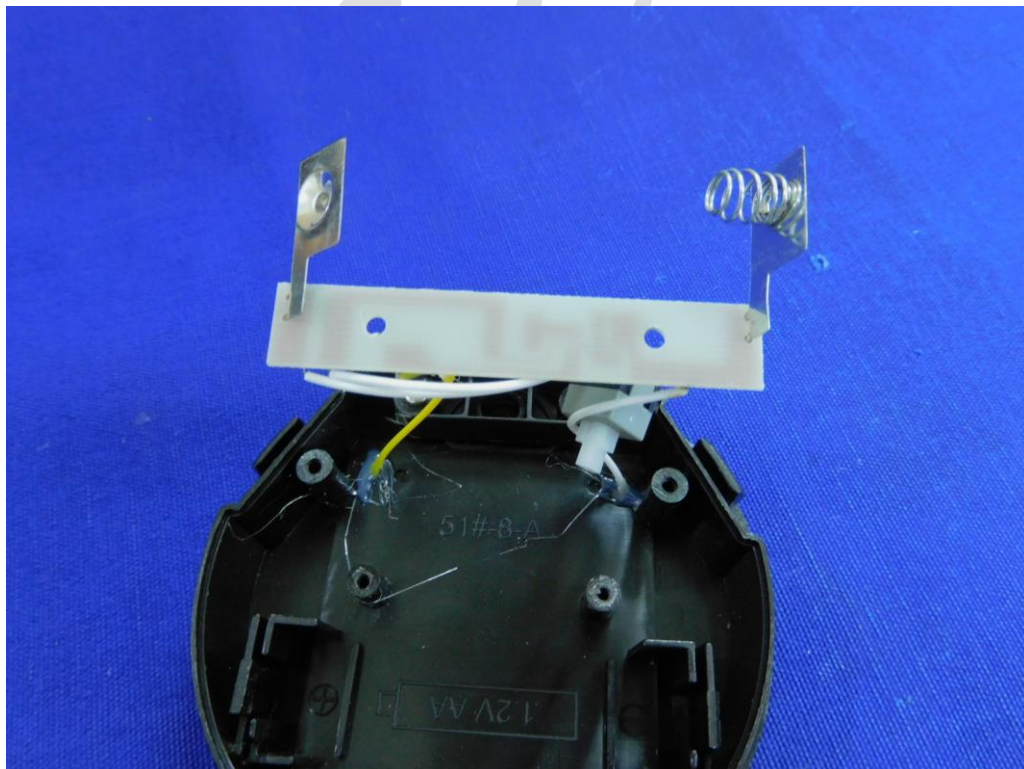

**APPENDIX B1: RADIATED EMISSION TEST SET-UP**

Front View

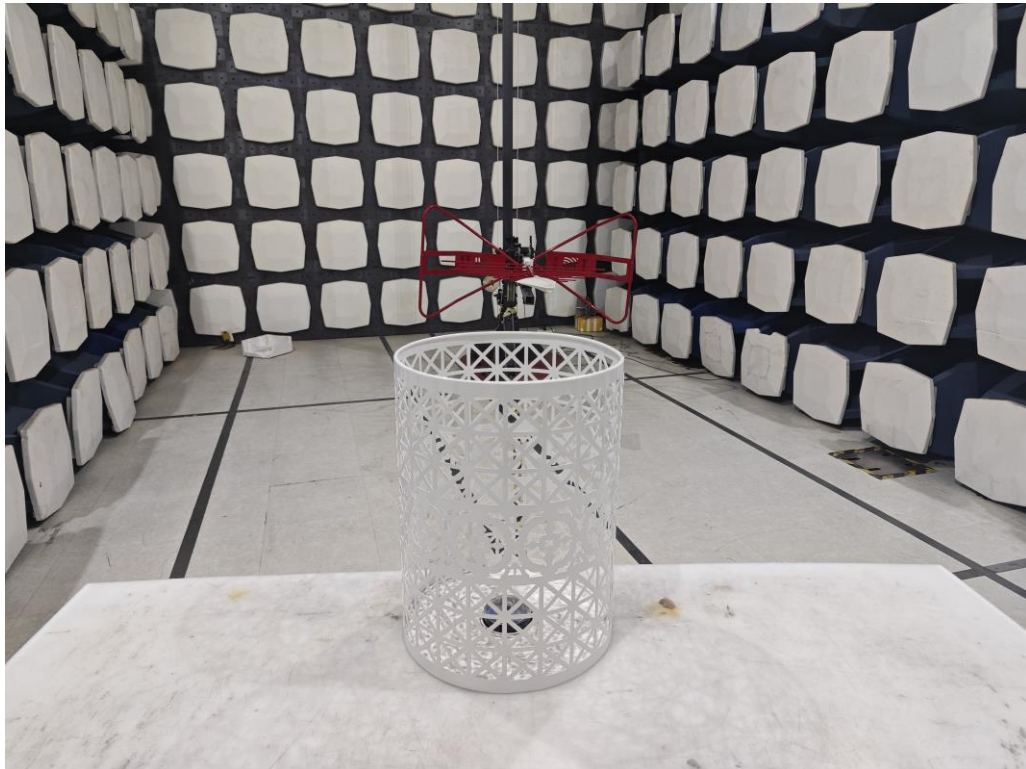

Back View



# Supplier's Declaration of Conformity Procedure Instruction Manual Requirements

The user's manual or instruction manual shall include the following statement in a prominent location in the text of the manual:

**This device complies with Part 15 of the FCC Rules. Operation is subject to the following two conditions: (1) this device may not cause harmful interference, and (2) this device must accept any interference received, including interference that may cause undesired operation.**

Note1: The above statement is applicable for when the device is so small or for such use that it is impracticable to label it with the statement specified under paragraph (a) of the 15.19 (detail contents refer to above) in a font that is four-point or larger, then the information required by this paragraph shall be placed in the user manual. In additional, If the 15.105 statement is in manual, this will suffice for the above (15.19(a) statement in manual) and for 2.1077 compliance statement

**Warning: Changes or modifications to this unit not expressly approved by the party responsible for compliance could void the user's authority to operate the equipment.**

**NOTE: This equipment has been tested and found to comply with the limits for a Class B digital device, pursuant to Part 15 of the FCC Rules. These limits are designed to provide reasonable protection against harmful interference in a residential installation. This equipment generates, uses and can radiate radio frequency energy and, if not installed and used in accordance with the instructions, may cause harmful interference to radio communications. However, there is no guarantee that interference will not occur in a particular installation. If this equipment does cause harmful interference to radio or television reception, which can be determined by turning the equipment off and on, the user is encouraged to try to correct the interference by one or more of the following measures:**

- Reorient or relocate the receiving antenna.
- Increase the separation between the equipment and receiver.
- Connect the equipment into an outlet on a circuit different from that to which the receiver is connected.
- Consult the dealer or an experienced radio/ TV technician for help.

And the following additional information shall be contained on device or in the user or instruction manual:

- 1) The Responsible (located within the United States) party information: Name, Address, Telephone Number or Internet contact information**
- 2) Identification of the product, e.g., name and model number**

If shielded cables or other specialized accessories are necessary for the unit to achieve compliance, a statement similar to the following should be added:

**Shielded cables must be used with this unit to ensure compliance with the Class B FCC limits.**

*Note2: For systems incorporating several digital devices, the above statement needs to be contained only in the user manual for the main control unit.*



## Supplier's Declaration of Conformity Labelling Requirements

Devices subject to FCC Part 15, Subpart B Supplier's Declaration of Conformity (S-DOC), a compliance information statement shall be supplied with the product at the time of marketing or importation:

**This device complies with Part 15 of the FCC Rules. Operation is subject to the following two conditions: (1) this device may not cause harmful interference, and (2) this device must accept any interference received, including interference that may cause undesired operation.**

Note3: When the device is so small, or for such use that it is impracticable to label it with the required compliance statement in a font that is four-point or larger, and the device is not capable of providing the information electronically, then the Section 15.19(a) (detail contents refer to above contents) statement shall be placed in the instruction manual. If an instruction manual is not provided or is only available electronically, then the Section 15.19(a) statement shall also be placed on the device packaging, paper insert or on a removable label attached to the device.

And place the identification of the product, e.g., trade name and model number, or other means employed utilizing the responsible party's internal manufacturing process on the device.

FCC logo on a voluntary basis as a visual indication that the product complies with the applicable FCC requirements

Note4: Where a device is constructed in two or more sections connected by wires and marketed together, the statement specified under paragraph (a) of this section is required to be affixed only to the main control unit.

Note5: The label on these products shall be permanently affixed to the product and shall be readily visible to the purchaser at the time of purchase. "Permanently affixed" means that the label is etched, engraved, stamped, silkscreened, indelibly printed, or otherwise permanently marked on a permanently attached part of the equipment or on a nameplate of metal, plastic, or other material fastened to the equipment by welding, riveting, or a permanent adhesive. The label must be designed to last the expected lifetime of the equipment in the environment in which the equipment may be operated and must not be readily detachable.