











Assembly Instructions

Caution : You must read this before you proceed

Care & Maintenance

- ⊘  ● Not for commercial use. For residential use only.
- ✓  ● Furniture may scratch floors. We recommend using furniture pads to protect your floors.
- ⊘  ● Do not put hot items directly on furniture surface.
- ⊘  ● Do not clean furniture with harsh cleansers or polish.
- ⊘  ● Do not place furniture under direct sunlight.
- ⊘  ● Do not place furniture near heating or cooling vents.
- ⊘  ● Do not write on furniture without a padded barrier to protect the surface.
- ⊘  ● Do not place furniture outside . For indoor use only.
- ⊘  ● Stains may be removed with mild soap solution and damp cloth.
- ⊘  ● Children should not climb or jump on the furniture.
- ✓  ● Dust and pick-up spills using a clean, non-colored, lint-free cloth.

Please look in under the seat for hardware packs and legs.



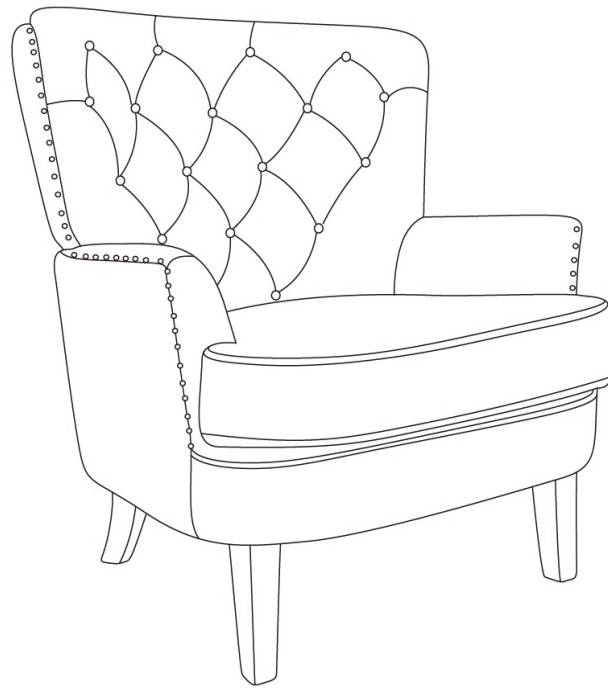

Club chair

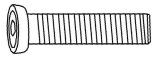

Parts List

| Label | Picture | Description | QTY (pc) |
|-------|--|-------------|----------|
| A | A line drawing of the tufted backrest part of the chair, showing the diamond-patterned tufting and the curved shape. | Back | 1 |
| B | Two line drawings of the back legs, showing their curved shape and the attachment points. | Back Leg | 2 |
| C | Two line drawings of the front legs, showing their straight shape and the attachment points. | Front Leg | 2 |
| D | A line drawing of the chair base, showing the seat and the curved backrest part. | Chair Base | 1 |

Hardware

| Label | Picture | Description | QTY (pc) |
|-------|---|---------------|----------|
| ① |  | Bolt(M8*55mm) | 9 |
| ② |  | Allen Wrench | 1 |
| ③ |  | Washer Ring | 9 |
| ④ |  | Spring Washer | 9 |

Assembly Preparation

Before Beginning Assembly:

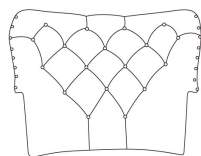

A

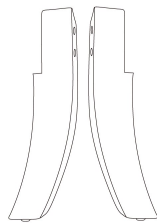

B



C

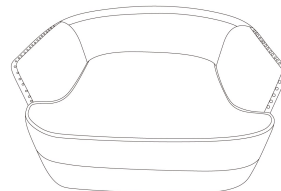

D



x9



x9



x9



• Read instructions, cover to cover.



• Have 2 adults on hand for assembly.



• Do not assemble on flooring or carpet.



• Assemble on a clean non-marring surface (packing foam).



• Save all packaging until finished.

Assembly Steps

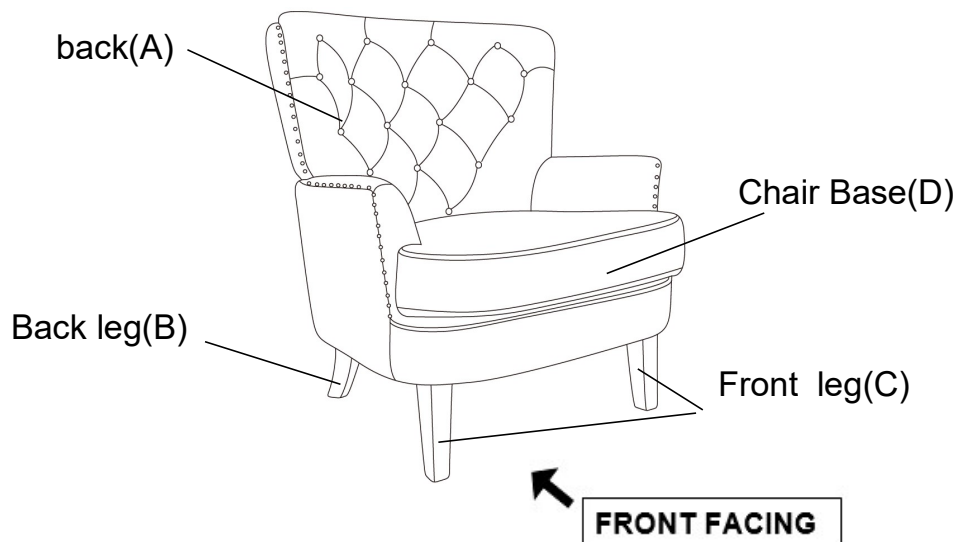

This Club chair may require up to some 30 minutes to assemble. To give you an overview of the product parts, the above picture is to help you put the various parts into perspective. Please read through the instructions below to familiarise yourself with the parts and steps before assembly.

Step 1

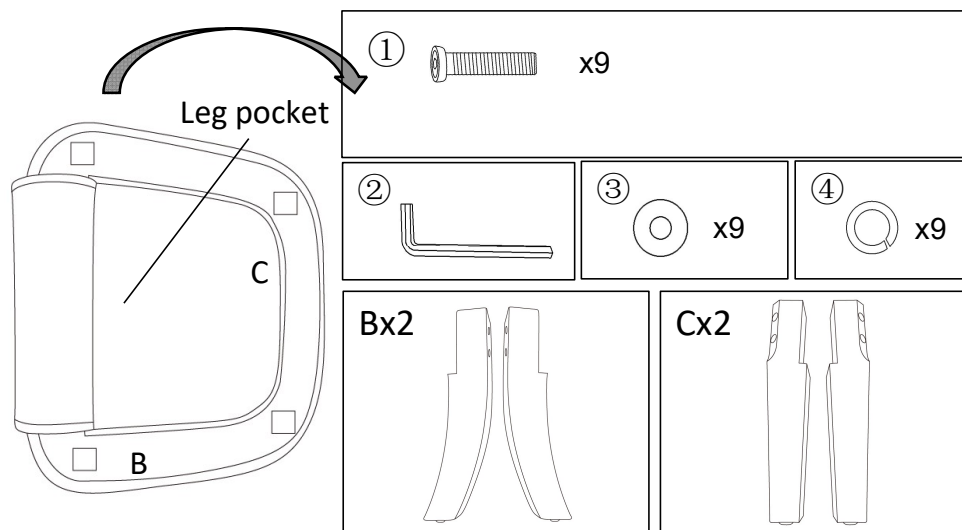

Take the Back Legs(B),Front leg (C),Bolt(①),Allen Wrench(②),Washer Rings(③) and Spring Washers(④) out from the leg pocket at the bottom of Chair base(D).

Step 2

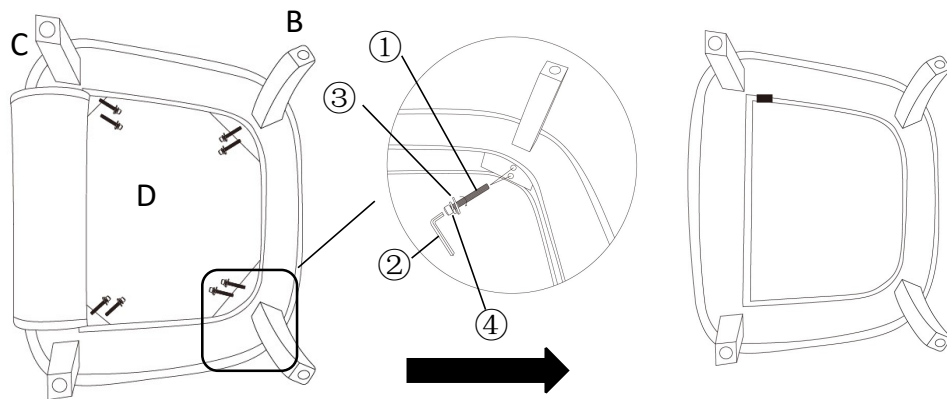

Install the Back Legs (B) at the bottom of the Chair Base(D).
using one Bolt(①) by placing one Washer Ring(③) and one Spring Washer(④)
on each one mountign position with Allen Wrench(②).
Repeat the same process to install the remaining three Legs.

Step 3

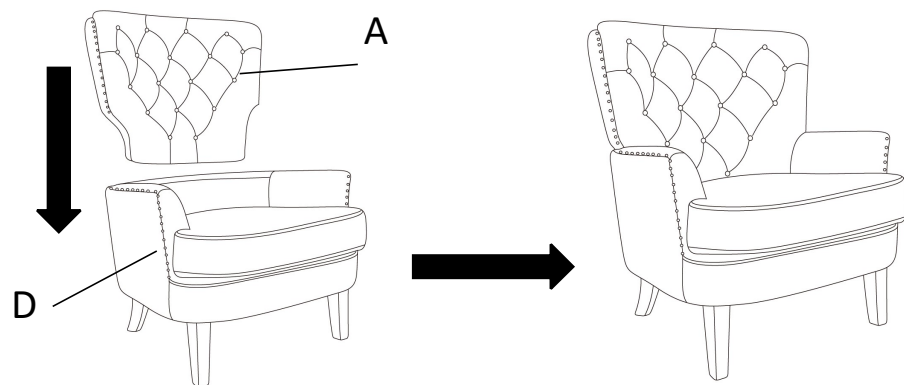

Pick up the Back(A) and then put the Back(A) on the seat of Chair Base(D)
until to the position.

Step 4

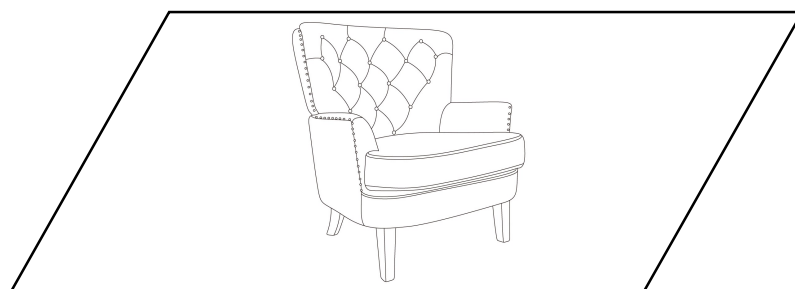

Your Club chair is ready for use.
This Club chair can only be used on a flat, level surface.