

# Assembly Instructions

**Caution : You must read this before you proceed**

**Please look in the Table Top for hardware packs**

## COFFEE TABLE

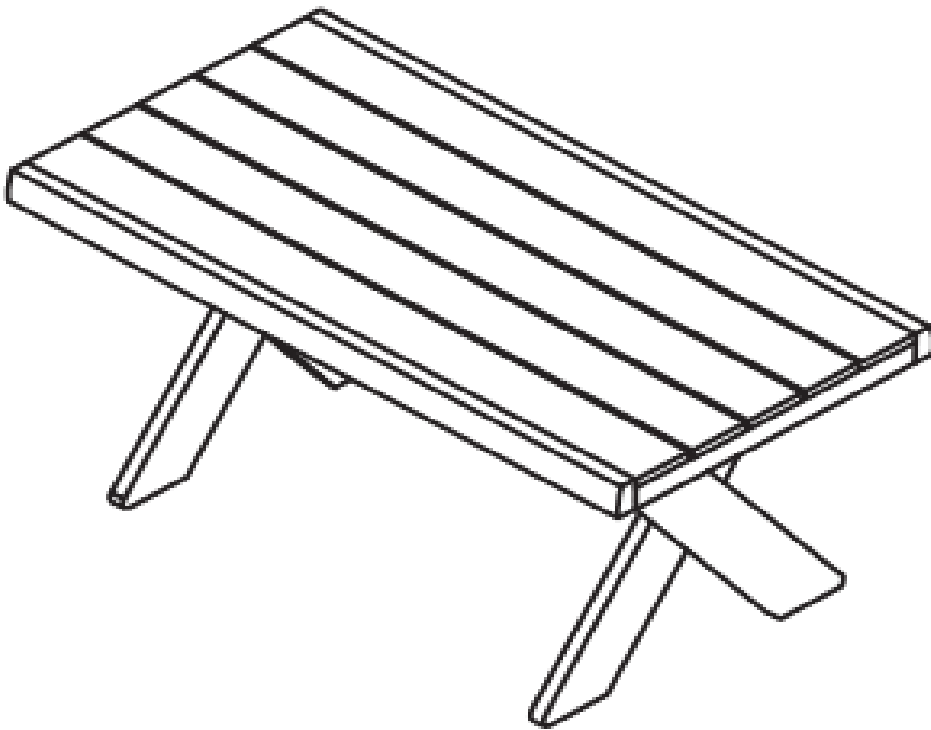

**CAUTION :** This Table is NOT a TOY.



Keep your child / children at bay during the assembly process.

For turning the Table and to prevent damage to the Table, 02 persons may be needed to execute this action.

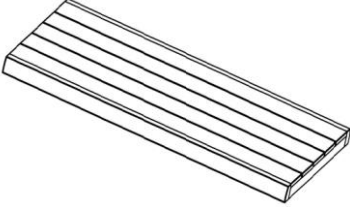
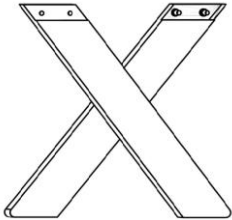
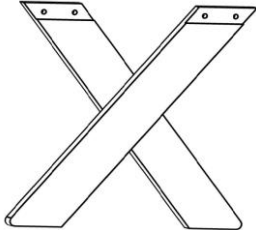
# Parts List

| Label | Picture   | Description | QTY |
|-------|---|-------------|-----|
| A     |    | Table Top   | 1   |
| B     |    | Right Leg   | 1   |
| C     |  | Left Leg    | 1   |

# Hardware

| Label | Picture   | Description    | QTY |
|-------|---|----------------|-----|
| ①     |  | Bolt (M8*30mm) | 9   |
| ②     |  | Allen Wrench   | 2   |

# Assembly Preparation

Before Beginning Assembly:

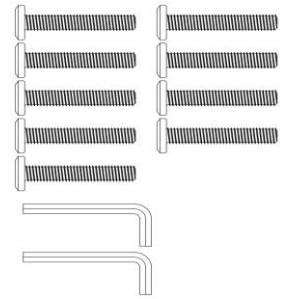
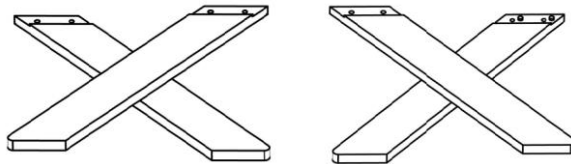
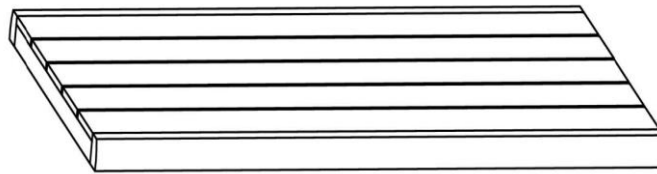

- Read instructions, cover to cover-



- Have 2 adults on hand for assembly-



- Do not assemble on flooring or carpet-



- Assemble on a clean non-marring surface (packing foam)-



- Save all packaging until finished-

## Assembly Steps

### Overview



This Table has multiple parts and may require up to 30 minutes to assemble. To give you an overview of the Table, the above picture is to help you put the various parts into perspective. Please read through the instructions below to familiarise yourself with the parts and steps before assembly.

## Step 1

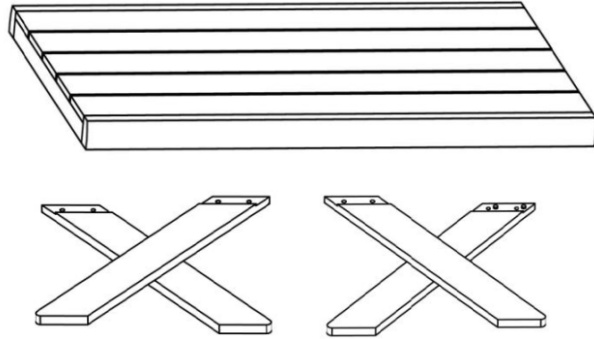

Unpack and place all parts on a clean, non-marring surface.

## Step 2

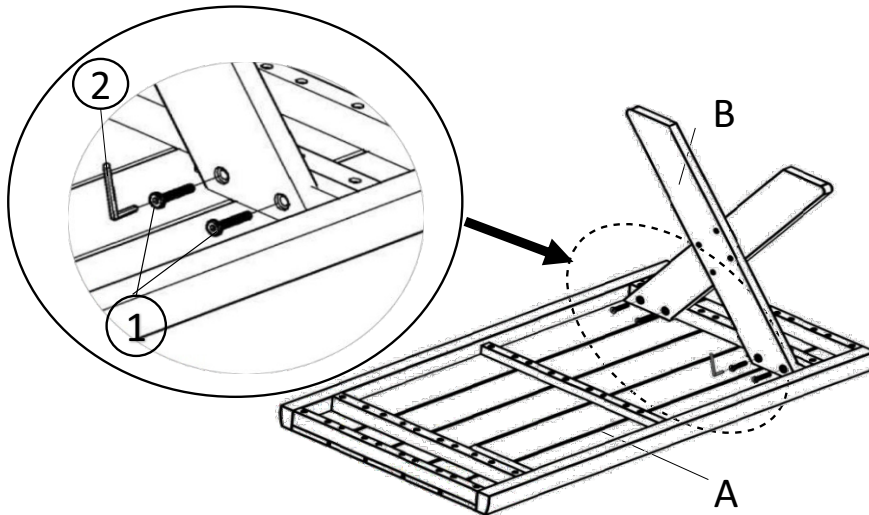

Attach Right Leg(B) to Table Top(A) by using 2 Bolts(1) with Allen Wrench(2) as shown above.

**Do not fully tighten the Bolts.**

## Step 3

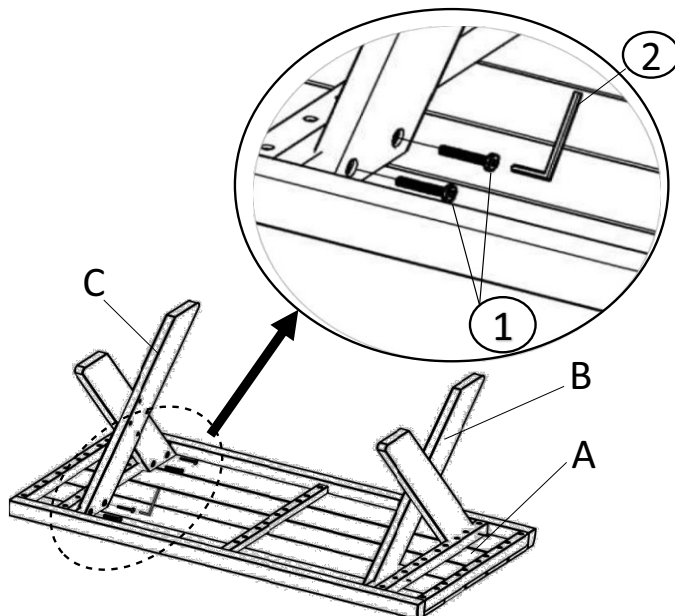

Attach Left Leg(C) to Table Top(A) by using 2 Bolts(1) with Allen Wrench(2) as indicated.  
**Do not fully tighten the Bolts.**

## Step 4



Place the Table onto a level surface, then EXERT pressure, floorwards, onto the Table. This pressure will help the Legs and Table Top reach full alignment at all joints.









**In a sequential manner, gradually tighten all Bolts until evenly secured.**

Inspect the Table and make sure all parts are adequately connected.

Your Table is ready for use.

**This Table can only be used on a flat, level surface.**

## Care & Maintenance

- ⊗  ● Do not put hot items directly on furniture surface.
- ⊗  ● Do not clean furniture with harsh cleansers or polish.
- ✓  ● To obtain the longest lifespan of your outdoor products, minimizing exposure to direct sunlight is recommended.
- ⊗  ● Children should not climb or jump on the furniture.
- ⊗  ● Do not write on furniture without a padded barrier to protect the surface.
- ✓  ● To obtain the longest lifespan of your outdoor products, avoid extended and lengthy exposure to rain, snow, and direct sunshine. Whenever possible cover the product and /or place under patio or awnings.
- ⊗  ● Not for commercial use. For residential use only.
- ⊗  ● Stains may be removed with mild soap solution and damp cloth.
- ✓  ● Dust and pick-up spills using a clean, non-colored, lint-free cloth .