

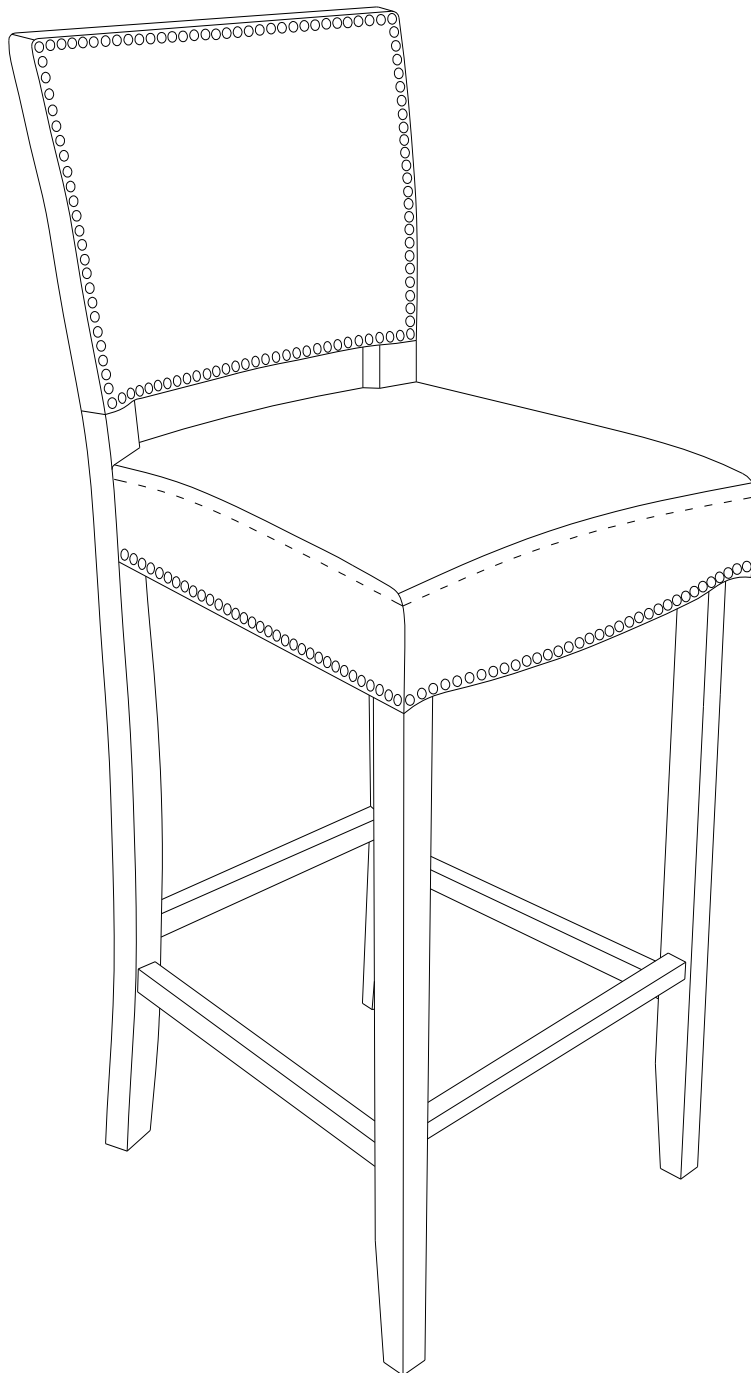



# Assembly Instructions

Caution: You must read this before you proceed.



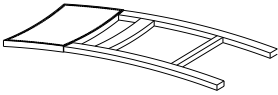

## Bar Chair

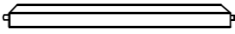
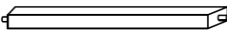
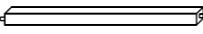



## Parts List

Part NO.	Picture	Description	QTY
A		Chair Back	1
B		Chair Seat	1
C		Left Front Leg	1
D		Right Front Leg	1
E		Left Side Rail	1
F		Right Side Rail	1
G		Front Rail	1

## Hardware

Label	Picture	Description	QTY
①		Bolt (M6x80mm)	4
②		Bolt (M6x50mm)	4
③		Bolt (M6x45mm)	2
④		Screw (M4x38mm)	6
⑤		Spring Washer	10

⑥		Washer	10
⑦		Allen Key	1
⑧		Screwdriver (Not provided)	1

## Assembly Preparation

### Before Beginning Assembly:

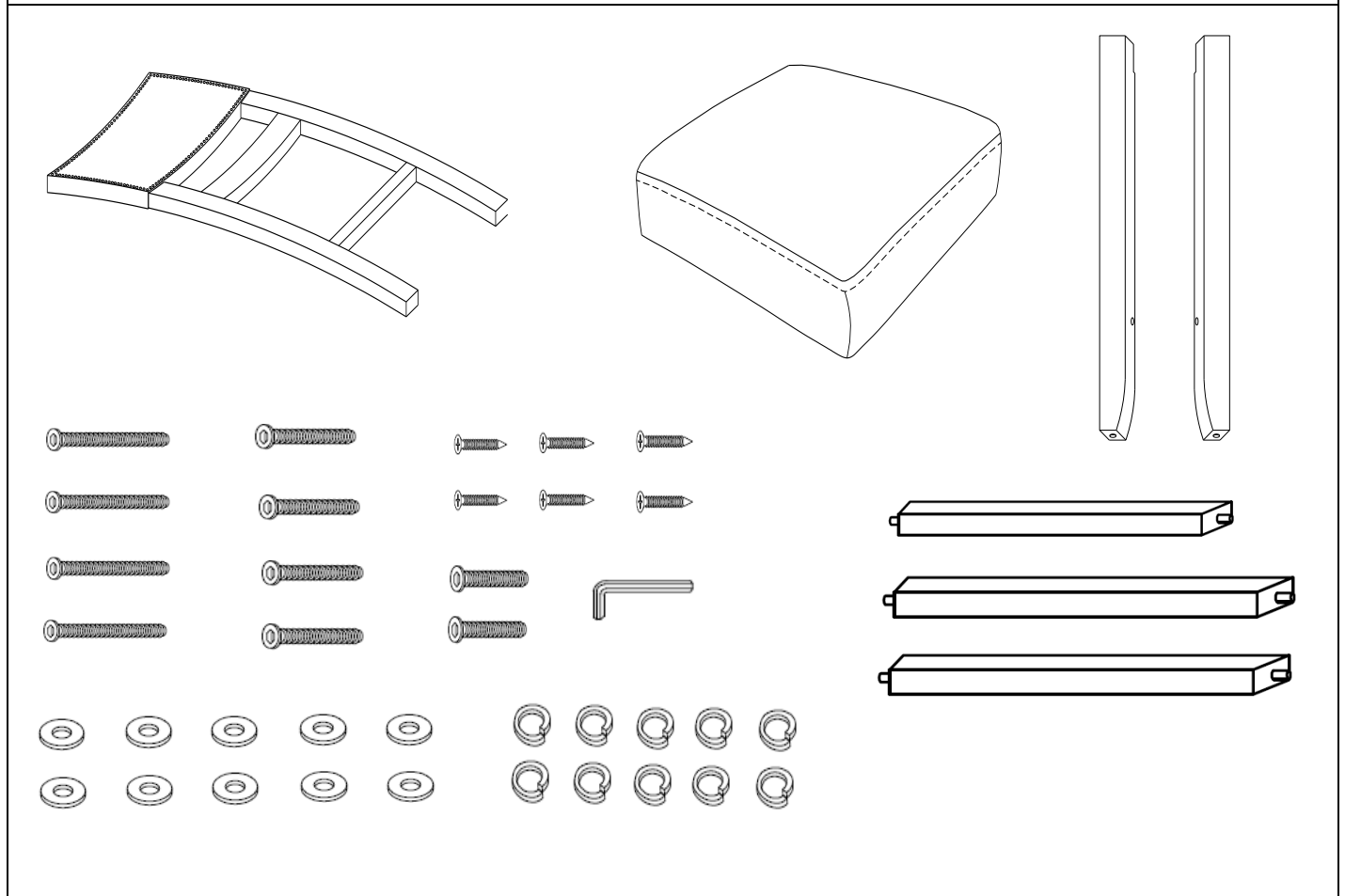

- Read instructions, cover to cover-



- Have 2 adults on hand for assembly-



- Do not assemble on flooring or carpet-



- Assemble on a clean non-marring surface (packing foam)-



- Save all packaging until finished-

# Assembly Steps

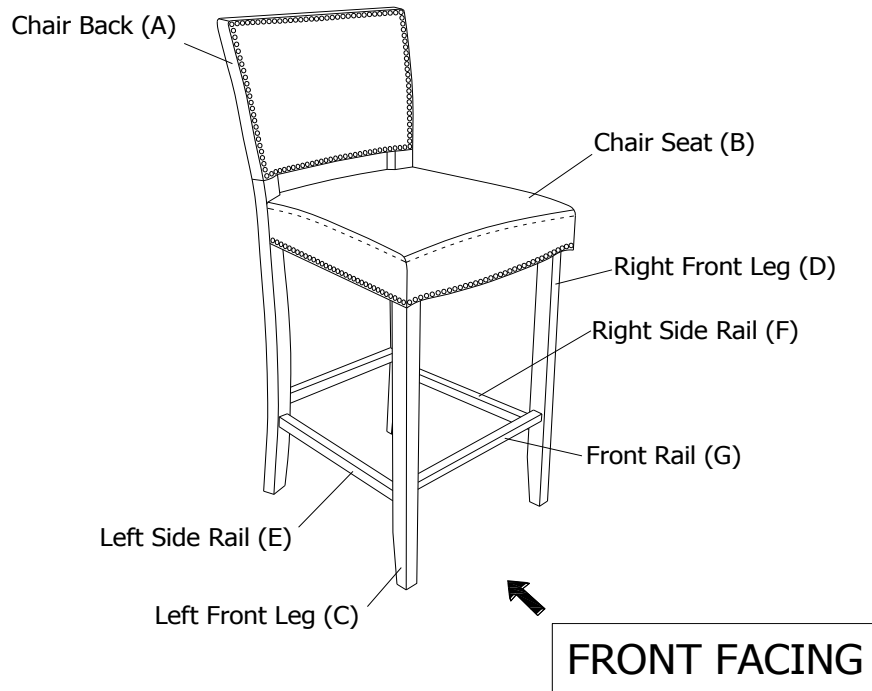

This Bar Chair has multiple parts and may require up to 30 minutes to assemble. To give you an overview of the Bar Chair parts, the above picture is to help you put the various parts into perspective. Please read through the instructions below to familiarise yourself with the parts and steps before assembly.

## Step 1

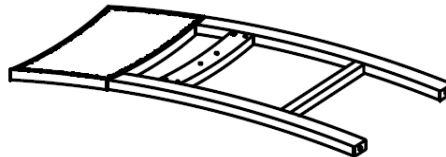

A. Chair Back

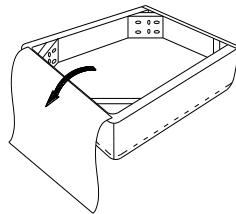

B. Chair Seat



C. Front Left Leg  
D. Front Right Leg

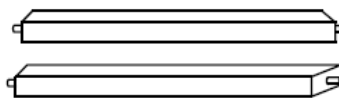

E. Left Side Rail  
F. Right Side Rail

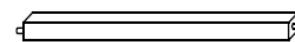

G. Front Rail

Place the Chair Back(A) and Chair Seat(B) on a clean, non-marring surface.  
Remove the Seat Base Cover from the underside of the Chair Seat(B) and take out all of the Parts and Hardware.

## Step 2

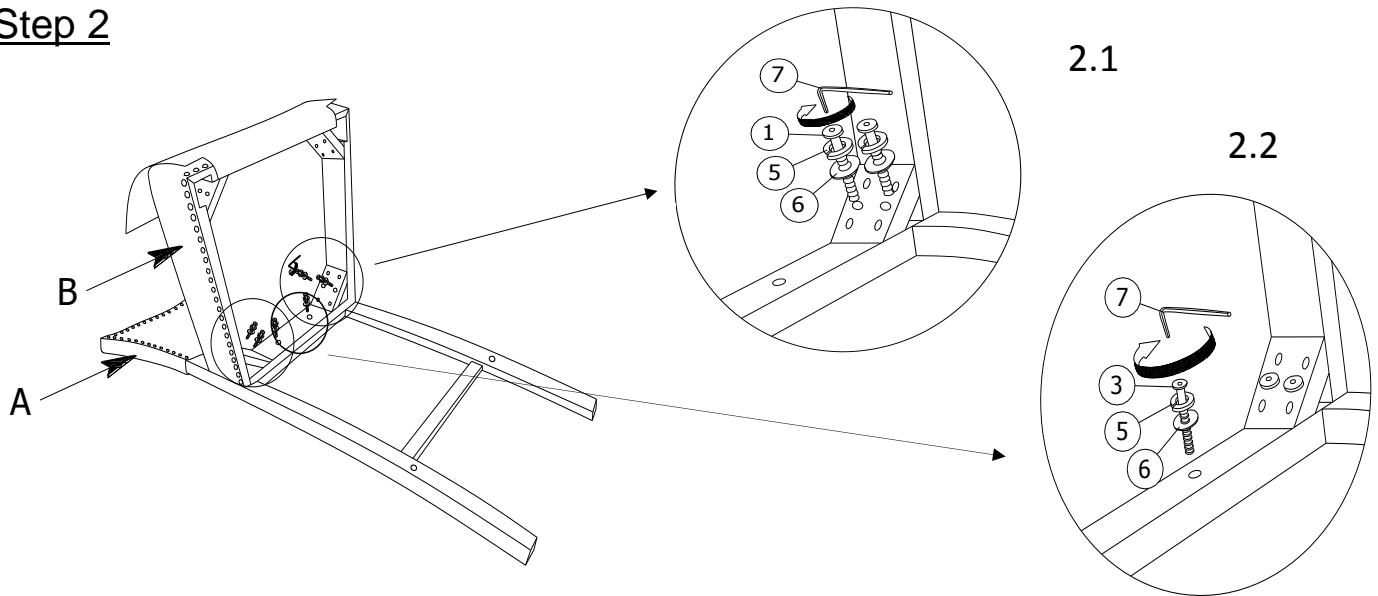

Align Chair Seat(B) to Chair Back(A) as shown above.

Use your hand to push the Chair Seat(B) firmly into Chair Back(A) to ensure there is no gap between them.  
Attach Chair Back(A) to Chair Seat(B) Step 2.1 using Bolts(①), Spring Washers(⑤), and Washers(⑥) with Allen Key(⑦). Step 2.2 using Bolts(③), Spring Washers(⑤), and Washers(⑥) with Allen Key(⑦).

**Do not fully tighten the Bolts.**

## Step 3

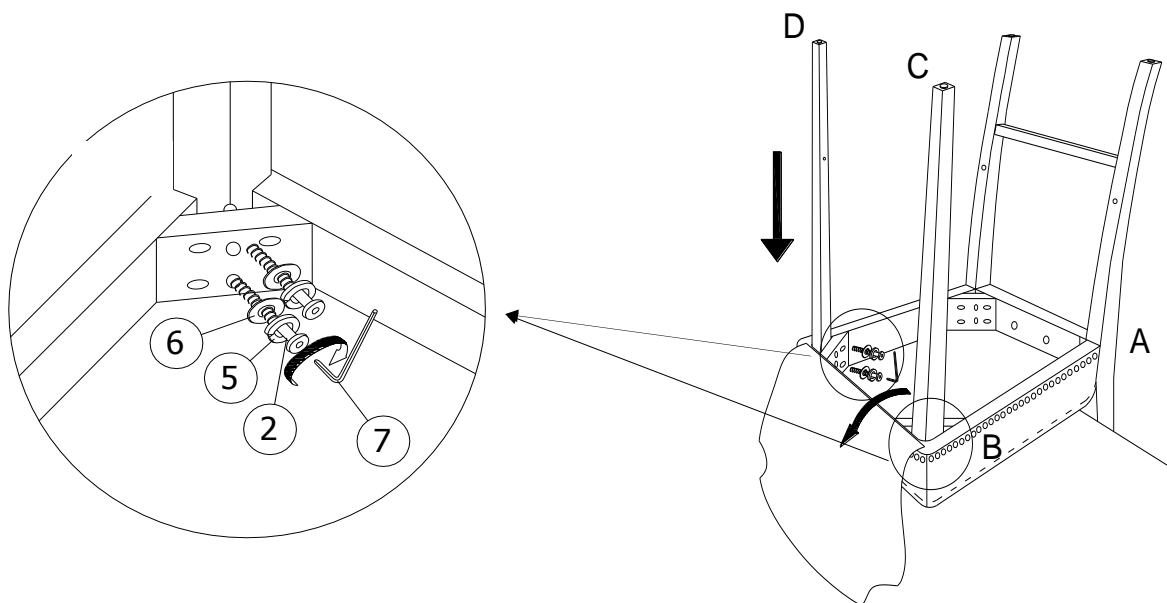

Insert the Front Left Leg(C) into the bottom of the Chair Seat(B).

Attach Front Left Leg(C) to Chair Seat(B) using Bolt(②), Spring Washer(⑤), Washer(⑥) and Allen Key(⑦).

**Do not fully tighten the Bolt.**

**Repeat the same process to assemble the Front Right Leg(D).**

## Step 4

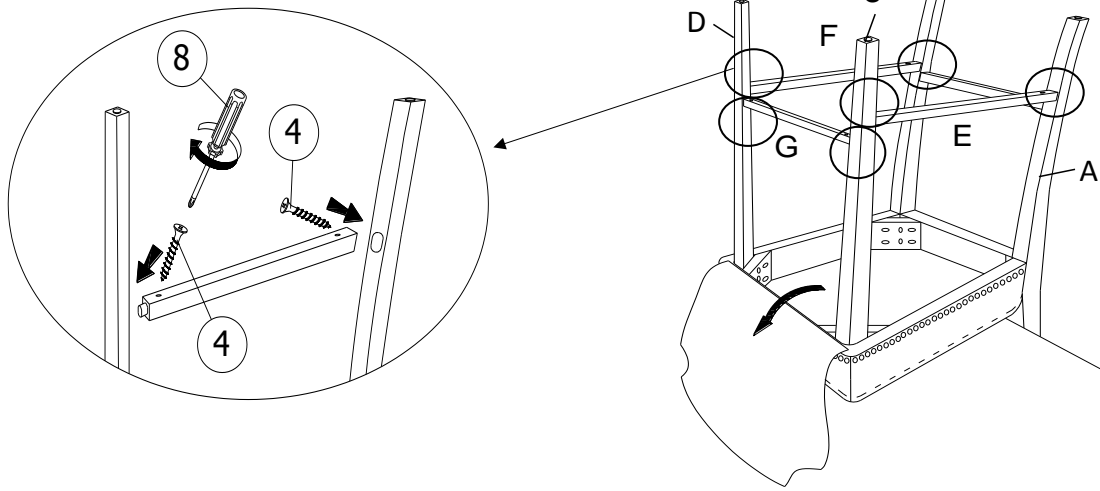

Insert Right Side Rail(F) into mounting positions between the Front Right Leg(D) and Chair back(A). Attach Right Side Rail(F) to Front Right Leg(D) and Chair back(A) using Screws(4) with Screwdriver(8). **Do not fully tighten the Screws.** Repeat the same process to assemble Front Rail(G) and Left Side Rail (E).

## Step 5

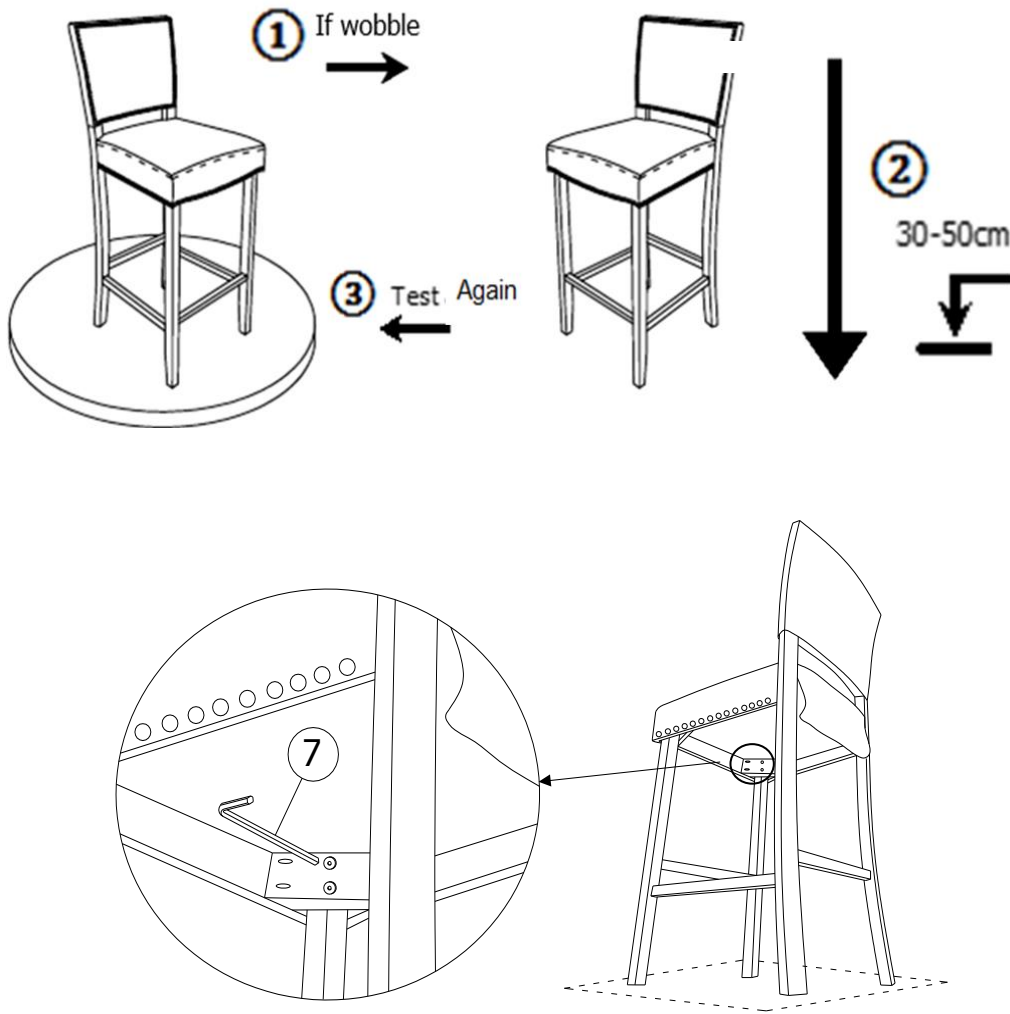

Place the Bar Chair on a LEVEL SURFACE to see if it wobbles.  
If it wobbles, lift the Bar Chair some 30cm to 50cm high from the ground.  
Keep your feet and toes well away from the drop zone.  
Drop the Bar Chair freely and vertically with all four legs, hitting the ground, at the same time.  
This Drop Test will help to ensure that all the Bolts and gaps to all reach full alignment status.  
Test again for evenness on a **LEVEL SURFACE**.  
If no wobbles found, proceed to tighten all the Bolts and Screws.  
**When tightening these Bolts, tighten sequentially.**  
**DO NOT tighten any Bolt fully and then move on towards the next one.**  
**This could cause the frame to warp.**  
If there is still wobbles, loosen the Bolts and execute this same drop test.

## Step 6

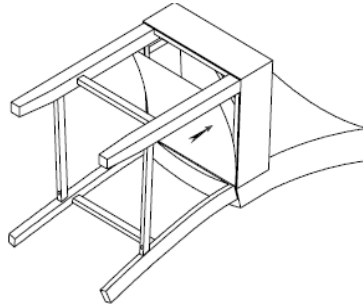









Place the Seat Base Cover back underneath the Chair Seat.  
Smooth down the Magic Tape by hand along all four sides at the edge of the Seat.

## Step 7



Stand the chair up. Your Bar Chair is ready for use.  
**This Bar Chair can only be used on a flat, level surface.**

## Care & Maintenance

-   ● Do not put hot items directly on furniture surface
  -   ● Do not clean furniture with harsh cleansers or polish.
  -   ● Do not place furniture under direct sunlight.
  -   ● Do not place furniture near heating or cooling vents.
  -   ● Do not write on furniture without a padded barrier to protect the surface.
  -   ● Do not place furniture outside . For indoor use only .
  -   ● Not for commercial use. For residential use only .
  -   ● Stains may be removed with mild soap solution and damp cloth.
  -   ● Children should not climb or jump on the furniture.
- 
-   ● Dust and pick-up spills using a clean, non-colored, lint-free cloth .

## Questions & Answers about Proposition 65

- What is Proposition 65?

Proposition 65 requires businesses to provide warnings to Californians about significant exposures to chemicals that cause cancer, birth defects or other reproductive harm. These chemicals can be in the products that Californians purchase, in their homes or workplaces, or that are released into the environment. By requiring that this information be provided, Proposition 65 enables Californians to make informed decisions about their exposures to these chemicals.

Proposition 65 also prohibits California businesses from knowingly discharging significant amounts of listed chemicals into sources of drinking water.

Proposition 65 requires California to publish a list of chemicals known to cause cancer, birth defects or other reproductive harm. This list, which must be updated at least once a year, has grown to include approximately 900 chemicals since it was first published in 1987.

- What types of chemicals are on the Proposition 65 list?

The list contains a wide range of naturally occurring and synthetic chemicals that include additives or ingredients in pesticides, common household products, food, drugs, dyes, or solvents. Listed chemicals may also be used in manufacturing and construction, or they may be byproducts of chemical processes, such as motor vehicle exhaust.

- What does a warning mean?

If a warning is placed on a product label or posted or distributed at a workplace, a business, or in rental housing, the business issuing the warning is aware or believes that it is exposing individuals to one or more listed chemicals.

By law, a warning must be given for listed chemicals unless the exposure is low enough to pose no significant risk of cancer or is significantly below levels observed to cause birth defects or other reproductive harm.

- Where can I get more information on Proposition 65?

If you have specific questions on the administration or implementation of Proposition 65, you can contact OEHHA's Proposition 65 program at [P65.Questions@oehha.ca.gov](mailto:P65.Questions@oehha.ca.gov), or by phone at (916) 445-6900.













