

Assembly Instructions

Caution: You must read this before you proceed

Please look underneath the Table Top for hardware packs

Table



Parts List

Label	Picture	Description	QTY
A		Table Top	1
B		Leg Panel	2
C		Leg Support Panel	2

Hardware

Label	Picture	Description	QTY
①		Allen Key	1
②		Washer	13
③		Bolt M6*20mm	13

Assembly Preparation

Before Beginning Assembly: Unpack all the parts for a clear overview.

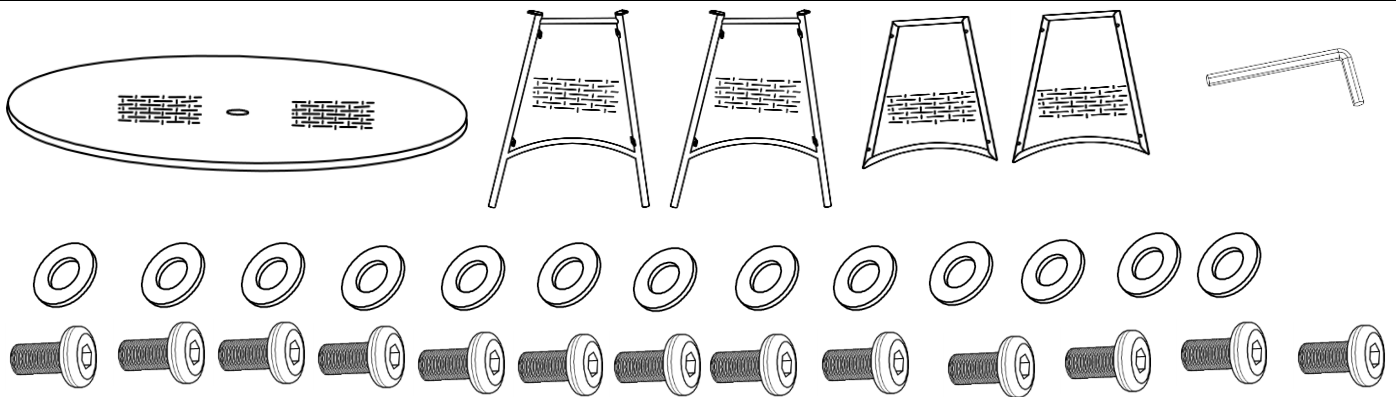

- Read instructions, cover to cover-



- Have 2 adults on hand for assembly-



- Do not assemble on flooring or carpet-



- Assemble on a clean non-marring surface (packing foam)-



- Save all packaging until finished-

Assembly Steps

Overview

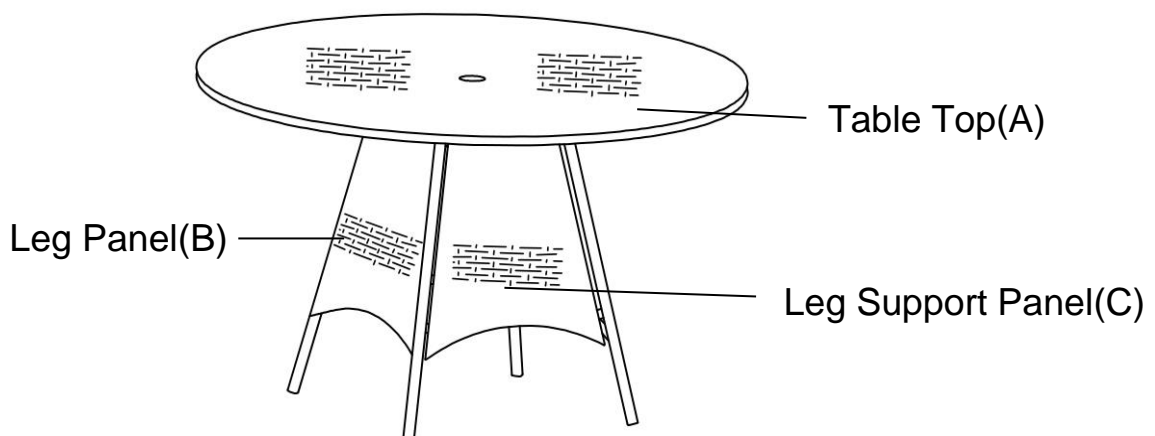

This Table has multiple parts and may require up to some 30 minutes to assemble. To give you an overview of the Table parts, the above picture is to help you put the various parts into perspective. Please read through the instructions below to familiarise yourself with the parts and steps before assembly.

Step 1

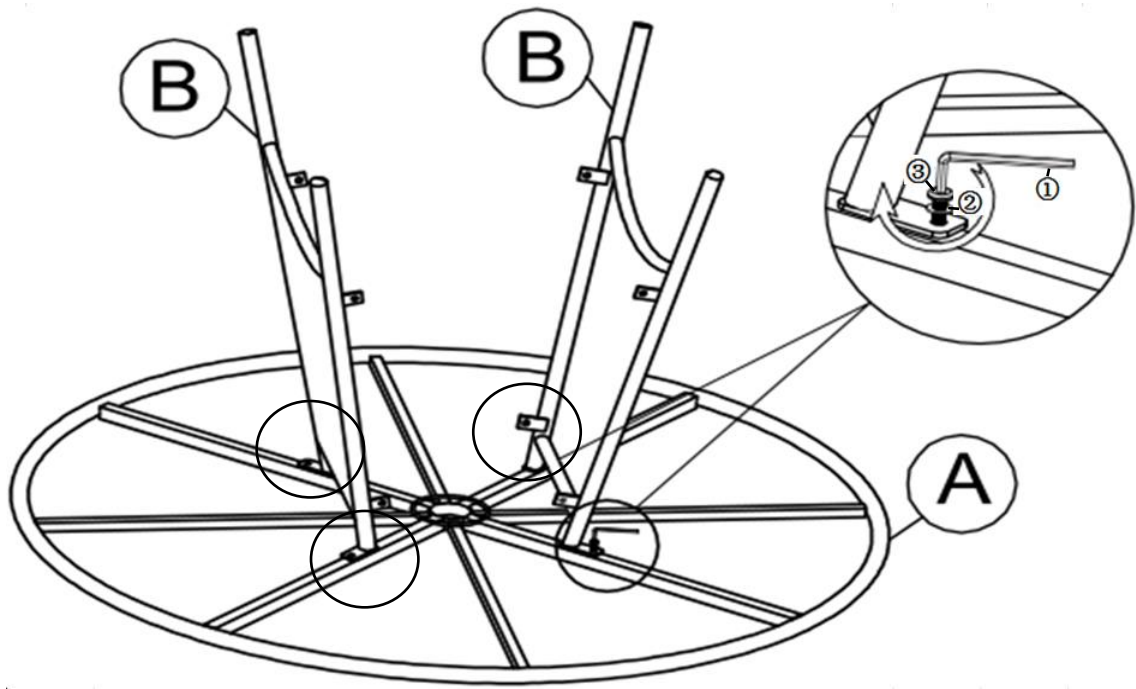

Open the carton and place all the parts on a clean, non-marring surface.
Turn table top upside down, then attach Leg Panel(B) to the Table Top(A) using Bolts(③) and Washers(②) with Allen Key(①) as shown in the picture above.
Repeat this process with the other Leg Panel (B)
Do not fully tighten the Bolts.

Step 2

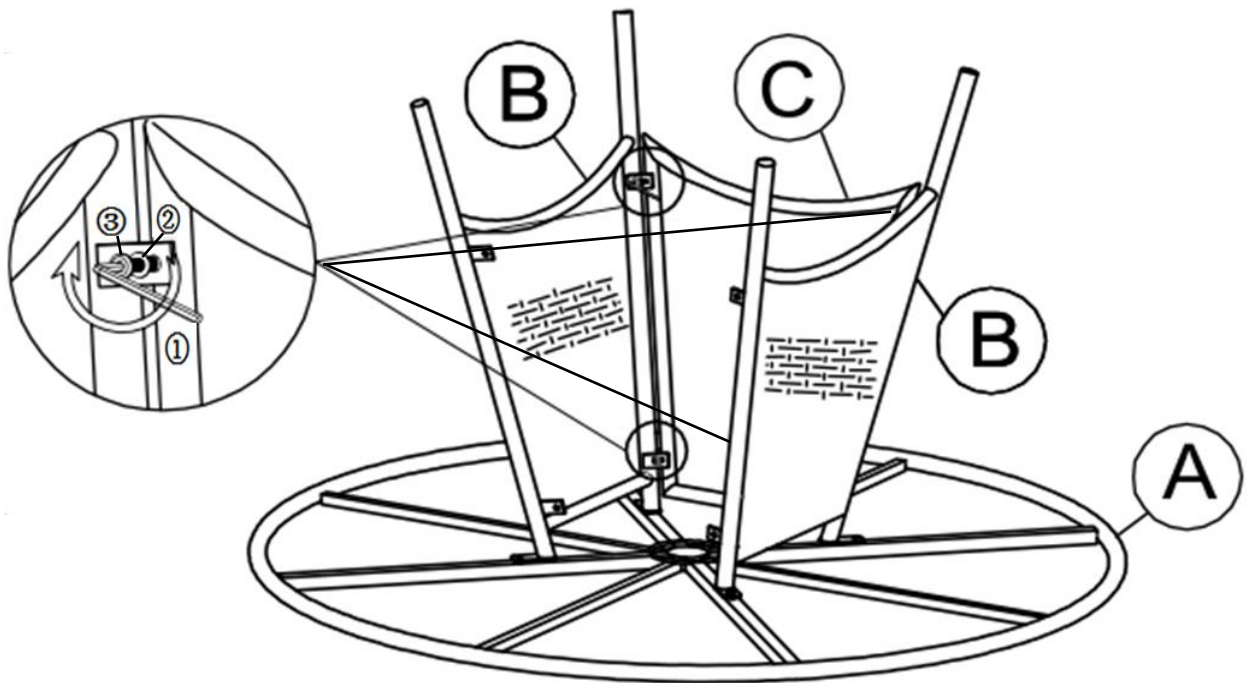

Attach Leg Support Panel(C) between Leg Panels(B) using Bolts(③) and Washers(②) with Allen Key(①) as shown in the picture above.
Repeat the same process to affix the another Leg Support Panel(C)
Do not fully tighten the bolts.

Step 3



Place the Table on a **LEVEL SURFACE** to check for wobbles.
If it wobbles, apply steady and even pressure down on the Table with the help of an adult partner.
Adjust the Legs Pre-installed Levellers until the Tables level with the ground. Adjust the levellers to the desired height to avoid wobbles.
When the Table is level proceed to tighten all Bolts at all joints.





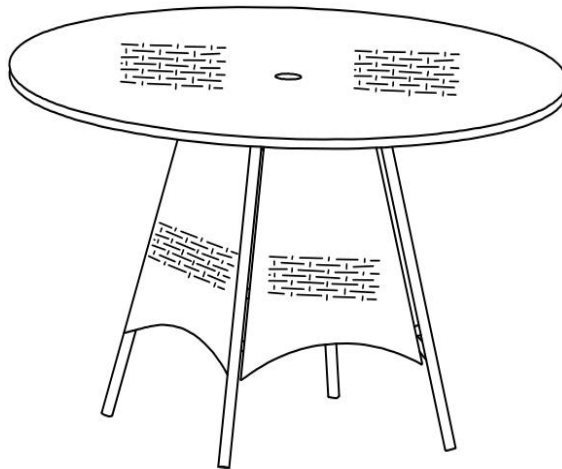















CAUTION : When tightening these bolts, tighten sequentially. DO NOT tighten any bolt fully and then towards the next one. This would cause the frame to warp.
If there is still wobbles, loosen the bolts and execute this same drop tests.
WARNING!! IF table IS NOT STABLE , IT COULD LEAD TO DAMAGING THE PRODUCT.

Step 4



Your Table is ready for use.
This Table can only be used on a flat, level surface.

Care & Maintenance

-   ● Do not put hot items directly on furniture surface
 -   ● Do not clean furniture with harsh cleansers or polish.
 -   ● To obtain the longest lifespan of your outdoor products, minimizing exposure to direct sunlight is recommended.
 -   ● Children should not climb or jump on the furniture.
 -   ● Do not write on furniture without a padded barrier to protect the surface.
 -   ● To obtain the longest lifespan of your outdoor products, avoid extended and lengthy exposure to rain, snow, and direct sunshine. Whenever possible cover the product and /or place under patio or awnings.
 -   ● Not for commercial use. For residential use only .
 -   ● Stains may be removed with mild soap solution and damp cloth.
 -   ● Keep away from sources of ignition.
-
-   ● Dust and pick-up spills using a clean, non-colored, lint-free cloth.