

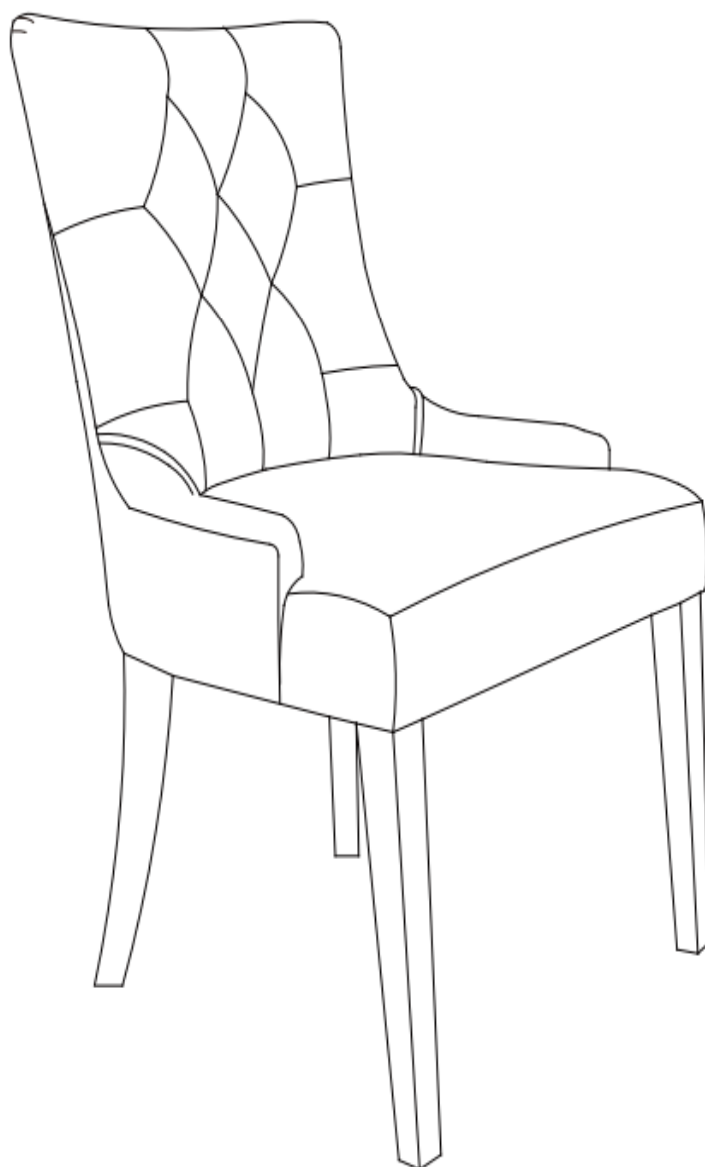



Assembly Instructions

Caution : You must read this before you proceed.





Dining Chair

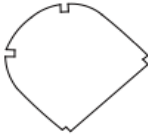

Parts List

Label	Picture	Description	Qty
A		Chair Seat	1
B		Back Wooden Leg	2
C		Front Wooden Leg	2
D		Seat Base Cover	1

Hardware

Label	Picture	Description	Qty
a		Bolt Dia.M8X60mm(L)	9
b		Spring Washer Ring	9
c		Flat Washer Ring	9
d		Allen Key	1

Assembly Preparation

Before Beginning Assembly:

Unpack all the parts for a clear overview

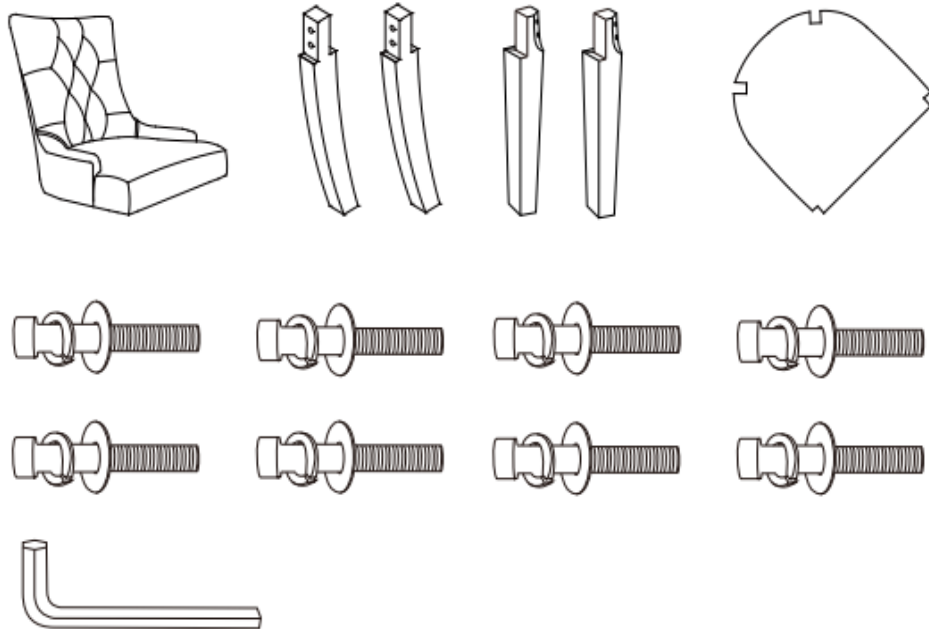

- Read instructions, cover to cover-



- Have 2 adults on hand for assembly-



- Do not assemble on flooring or carpet-



- Assemble on a clean non-marring surface (packing foam)-



- Save all packaging until finished-

Assembly Steps

Step 1

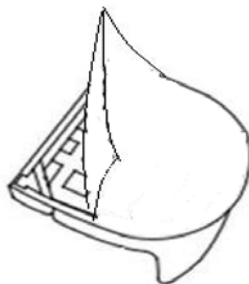

Position the Chair on its back, as shown.

Preferrably on a surface that will not scratch the upholstery.

Take out the 4 wooden legs and the package of hardware accessories under the chair seat.

Step 2

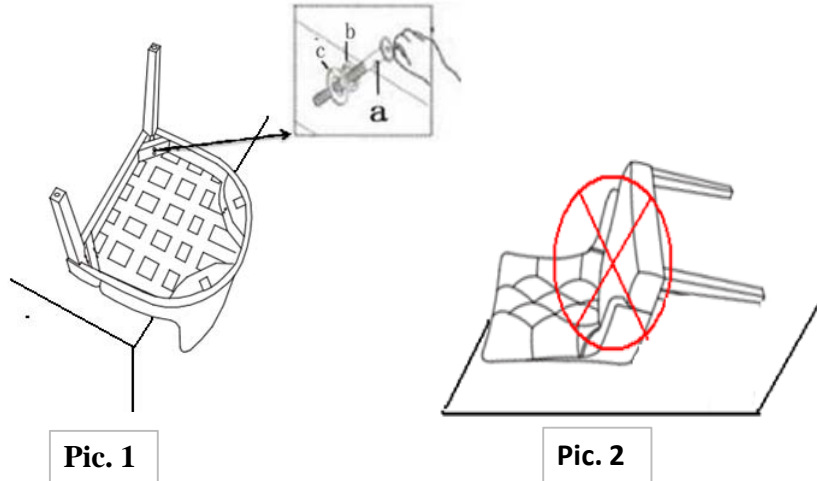

Place the chair onto the side of a table as seen in Picture(1) .
You will now have the chair bottom facing skywards.
Insert each Front Leg completely and vertically into each Front seat frame corner.
PRESS FIRMLY DOWNWARDS with your hand until there is no gap.

Affix the front legs with 4 Bolts (a) and 4 Spring Washers (b) and 4 Flat Washers (c) using the Allen key(d).

DO NOT overtighten the bolts.

WARNING!! DO NOT OVER TIGHTEN.
OVER TIGHTENING COULD LEAD TO DAMAGE OF THE PRODUCT.
TIGHTEN ONLY UNTIL SECURE AND STABLE.

WARNING!! DO NOT POSITION THE FRONT LEG AS SHOWN IN **PIC.2**
THIS PICTURE SHOWS THE CHAIR BACK FLAT ON THE GROUND and THE FRONT LEGS HORIZONTAL IN MIDAIR.

Step 3

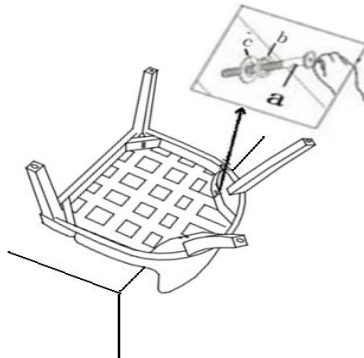

Insert each hind leg completely vertically into each back seat frame corner.
PRESS FIRMLY DOWNWARDS with your hand until there is no gap.
Using the Allen key(d), fix the hind legs with 4 Bolts (a) and 4 Spring Washers (b) and 4 Flat Washers (c) .
At this point of assembly, **DO NOT** overtighten the bolts.

WARNING!! DO NOT OVER TIGHTEN.
OVER TIGHTENING COULD LEAD TO DAMAGE OF THE PRODUCT.
TIGHTEN ONLY UNTIL SECURE AND STABLE.

Step 4 DROP TEST

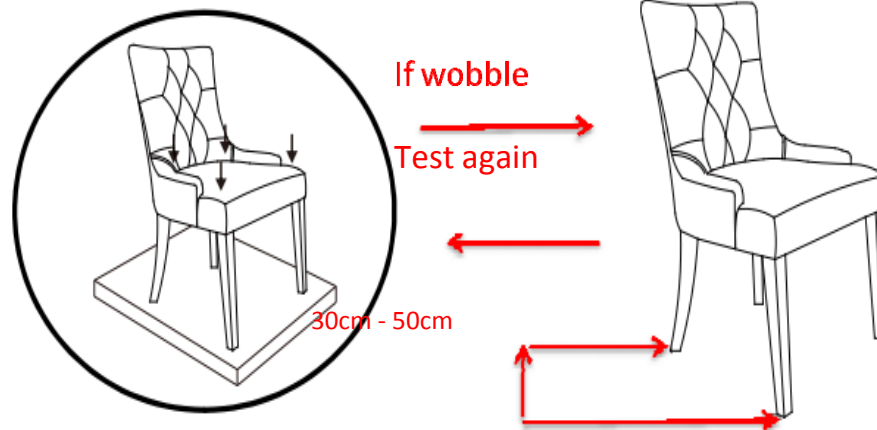

Place the chair on a **LEVEL SURFACE** to see if it wobbles.
If it wobbles, lift the chair to some **30cm to 50cm** height from the ground.
Keep your feet and toes well away from the drop zone.
Drop the chair freely and vertically with the four legs, hitting the ground, at the same time.
This "drop" helps to ensure that all the bolts and gaps to all reach full alignment status.
Test again for evenness on a **LEVEL SURFACE**.
If no wobbles found, proceed to fully tighten all the bolts.
CAUTION : When tightening these bolts, tighten sequentially.
DO NOT tighten any screw fully and then towards the next one.
This would cause the frame to warp.
If there is still wobbles, loosen the bolts and execute this same drop tests.





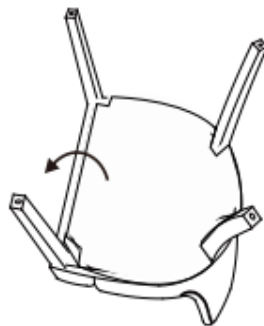



WARNING!! IF, THE CHAIR IS NOT STABLE , IT COULD LEAD TO DAMAGES IN THE PRODUCT

Step 5



Finally, seal the Seat Base Cover back on to the underside of the chair seat .
Turn it the right side up.
The chair is ready for use.

Care & Maintenance

-  ● Do not put **HOT** items directly on furniture surface.
 -  ● Do not clean furniture with **HARSH** cleansers or polish.
 -  ● Do not place furniture under **DIRECT** sunlight.
 -  ● Do not place furniture near **heating or cooling** vents.
 -  ● Do not write on furniture without a padded barrier to protect the surface.
 -  ● For indoor use only. Do not place furniture outside.
 -  ● For residential use only. Not for commercial use.
 -  ● Stains may be removed with mild soap solution and damp cloth.
-
-  ● Dust and pick-up spills using a clean, non-colored, lint-free cloth.