

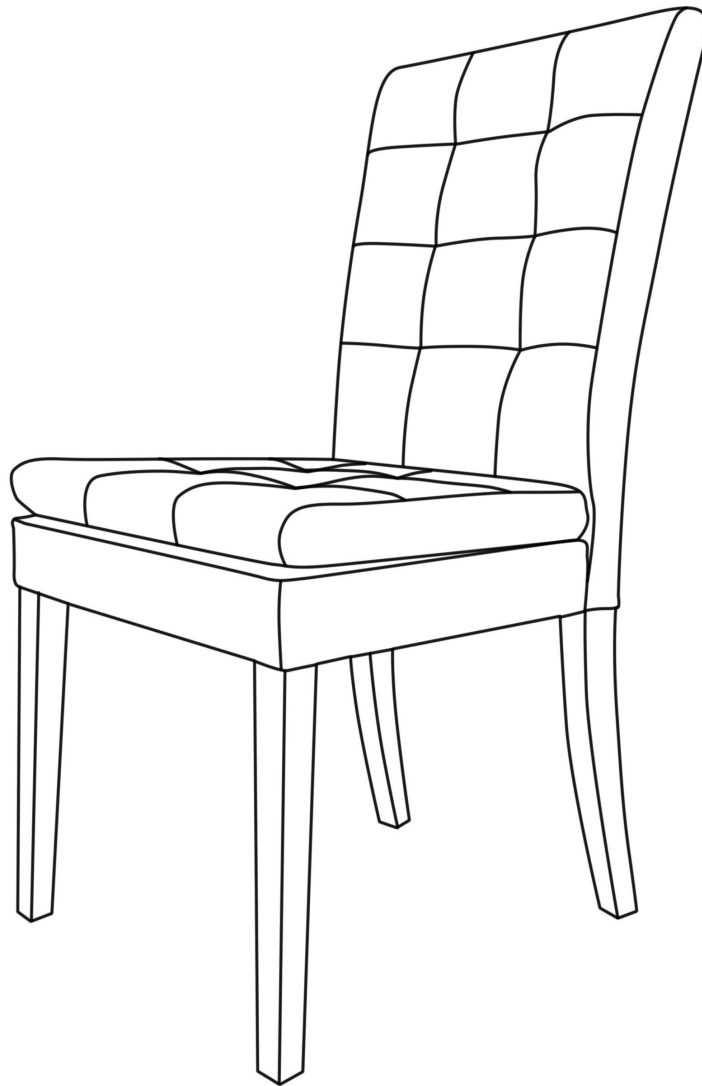

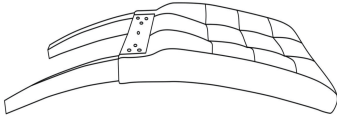

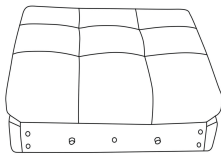

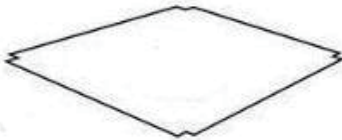

# Assembly Instructions

Caution : You must read this before you proceed

## Dining Chair

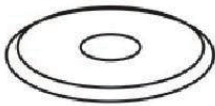

<u>Parts List</u>			
Label	Picture	Description	Qty
A		Chair Back	1
B		Chair Seat	1
C		Frongt Wooden Leg	2
D		Seat Base Cover	1

<u>Hardware</u>			
Label	Picture	Description	Qty
①		Bolt Dia.M8X55mm(L)	6
②		Flat Washer Ring	10
③		Spring Washer Ring	10
④		Allen Key	1
⑤		Bolt Dia.M8X75mm(L)	5

# Assembly Preparation

Before Beginning Assembly:

Unpack all the parts for a clear overview.

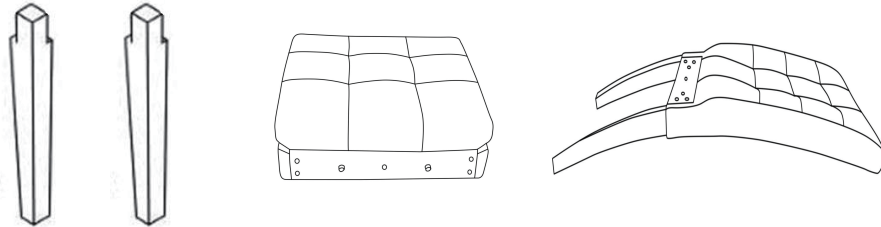

**Pack A** for Locking the front legs to the front corner blocks of the seat:

Four Dia.M8 Bolt:55mm(L)+four flat washer ring+four spring washer ring

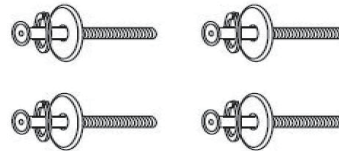

**Pack B** for locking the back panel of the seat to the horizontal panel of the backrest:

Four Dia.M8 Bolt:75mm(L)+four flat washers+four spring washers  
One Dia.M8 Bolts:55mm(L)+one flat washers +one spring washers

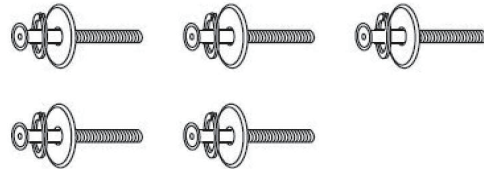

**Allen Key**



- Read instructions, cover to cover-



- Have 2 adults on hand for assembly-



- Do not assemble on flooring or carpet-



- Assemble on a clean non-marring surface (packing foam)-



- Save all packaging until finished-

## Assembly Steps

### Step 1

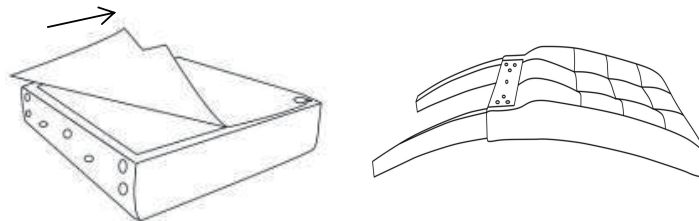

Place the chair back (A) on a soft surface to avoid any scratches on the products.

Take out the 2 wooden legs and the package of hardware accessories.

### Step 2

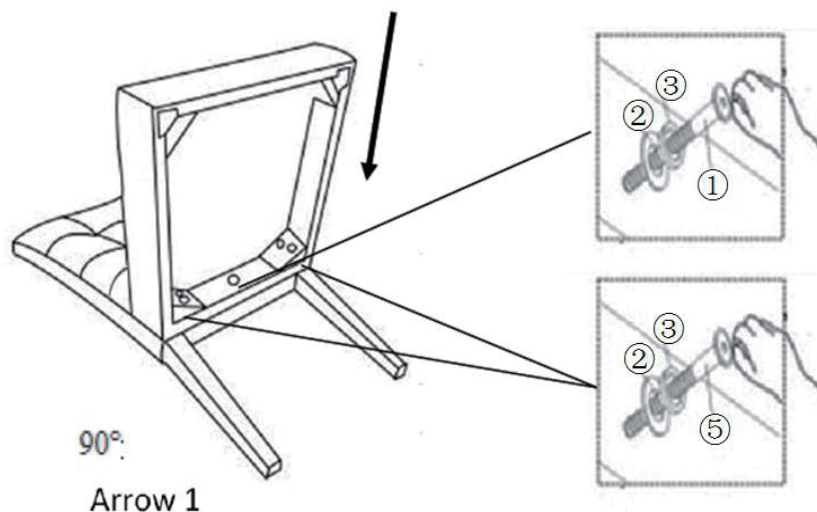

Put the chair back(A) onto a flat table or panel.  
Align the holes on chair back(A) to the holes on chair seat frame.  
Use your left hand to push the seat frame floorwards, depicted by Arrow 1.

This action helps to ensure the chair seat(B) is pressed towards to the chair back(A) with no gap between these.

Then, lock the middle hole and the corner holes.

The hardware for these are : use 4 Bolts (⑤)+ +1 Bolts (①)+5 Flat Washer Rings (②) + 5 Spring Washer Rings (③) with the Allen key(④).

At this point of assembly, DO NOT overfasten the connections.



### Step 3

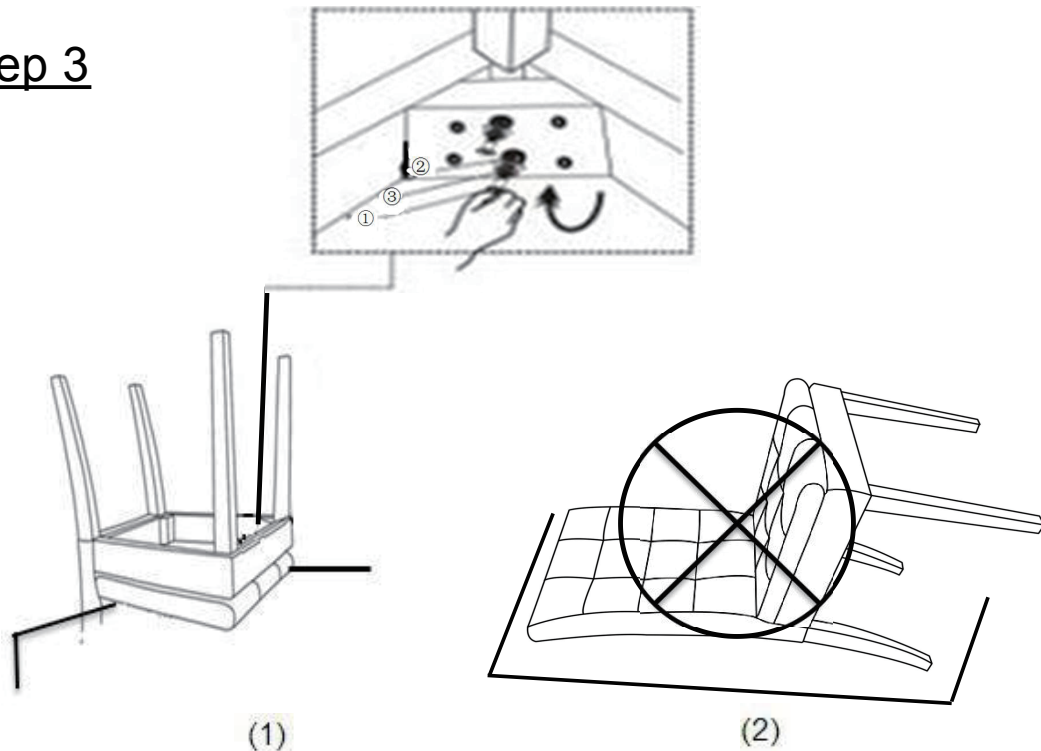

Next, place the chair onto the side of a table as seen in Picture 1. You will now have the chair bottom and all 4-legs facing skywards.

Insert each front leg completely vertically into each seat frame corner.

**PRESS FIRMLY DOWN** with your hand until there is no gap.

**WARNING!! DO NOT POSITION THE FRONT WOODEN LEG AS SHOWN IN PICTURE 2 .**

**THIS PICTURE SHOWS THE CHAIR BACK STAYS AGAINST THE GROUND and THE FRONT LEGS HORIZONTAL IN MIDAIR.**

Now tighten the bottom bolt at first, then the blot on the top by using 4 Bolts(①)+4 Flat washer Rings(②)+4 Spring washer Rings (③) with your hands.

**DOT NOT** tighten the top bolt first.

**WARNING!! DO NOT OVER TIGHTEN. OVER TIGHTENING COULD LEAD TO DAMAGING THE PRODUCT. TIGHTEN ONLY UNTIL SECURE AND STABLE.**

## DROP TEST

### Step 4

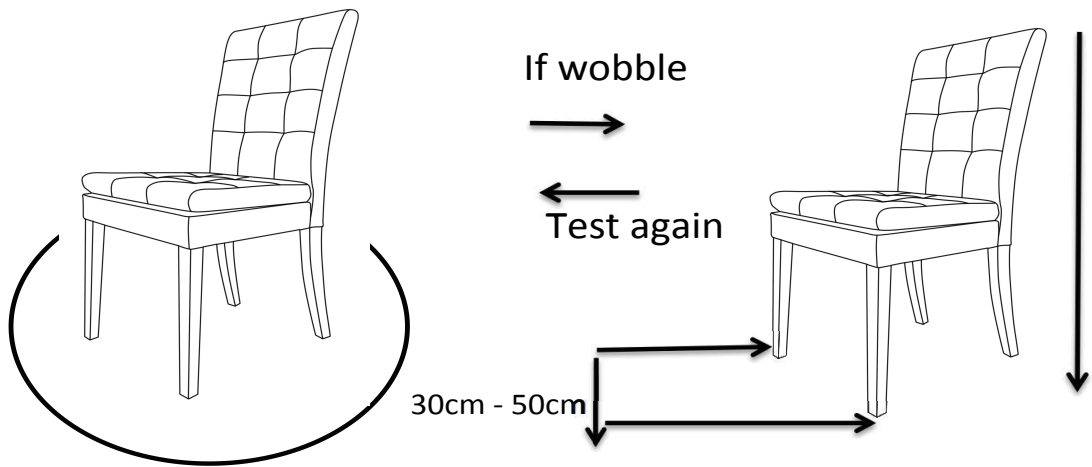

Place the chair on a **LEVEL SURFACE** to see if it wobbles. If it wobbles, lift the chair to some 30cm to 50cm height from the ground.

Keep your feet and toes well away from the drop zone.

Drop the chair freely and vertically with the four legs, hitting the ground, at the same time.

This Drop Test will help to ensure that all the bolts and gaps to all reach full alignment status.

Test again for evenness on a **LEVEL SURFACE**.

If no wobbles found, proceed to tighten all the bolts.

**CAUTION** : When tightening these bolts, tighten sequentially.

**DO NOT** tighten any screw fully and then towards the next one.

This would cause the frame to warp.

If there is still wobbles, loosen the bolts and execute this same drop tests.





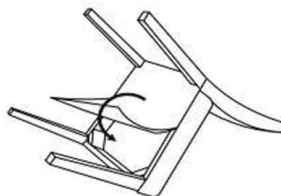















**WARNING!! IF CHAIR IS NOT STABLE , IT COULD LEAD TO DAMAGING THE PRODUCT.**

### Step 5



Finally, seal the Seat Base Cover back on to the underside of the chair seat . Turn it the right side up. The chair is ready for use.

## Care & Maintenance

-   • Do not put hot items directly on furniture surface
  -   • Do not clean furniture with harsh cleansers or polish.
  -   • Do not place furniture under direct sunlight.
  -   • Do not place furniture near heating or cooling vents.
  -   • Do not write on furniture without a padded barrier to protect the surface.
  -   • Do not place furniture outside . For indoor use only .
  -   • Not for commercial use. For residential use only .
  -   • Stains may be removed with mild soap solution and damp cloth.
  -   • Children should not climb or jump on the furniture.
- 
-   • Dust and pick-up spills using a clean, non-colored, lint-free cloth .