

# Assembly Instructions

**Caution : You must read this before you proceed**

Sets often ship in multiple boxes and may arrive a day or two apart.

## Care & Maintenance



- Not for commercial use. For residential use only.



- Prolonged exposure to rain may cause rusting which can stain floors.



- Do not put hot items directly on furniture surface.



- Do not clean furniture with harsh cleansers or polish.



- To obtain the longest lifespan of your outdoor products, minimizing exposure to direct sunlight is recommended.



- Children should not climb or jump on the furniture.



- Do not write on furniture without a padded barrier to protect the surface.



- To obtain the longest lifespan of your outdoor products, avoid extended and lengthy exposure to rain, snow, and direct sunshine. Whenever possible cover the product and /or place under patio or awnings.



- Stains may be removed with mild soap solution and damp cloth.



- Keep away from sources of ignition.





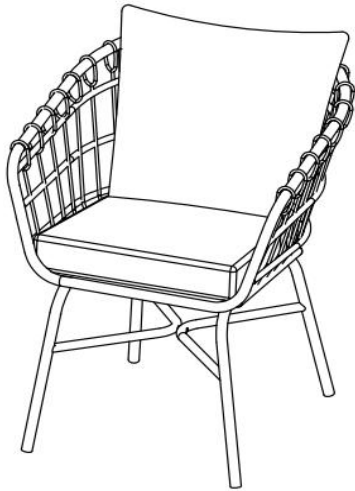

- Dust and pick-up spills using a clean, non-colored, lint-free cloth.

# Chair



## Part List

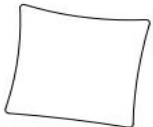



Label	Picture	Description	QTY
A		Seat	1
B		Left Leg	1
C		Right Leg	1
D		Seat Cushion	1
E		Back Cushion	1

## Hardware

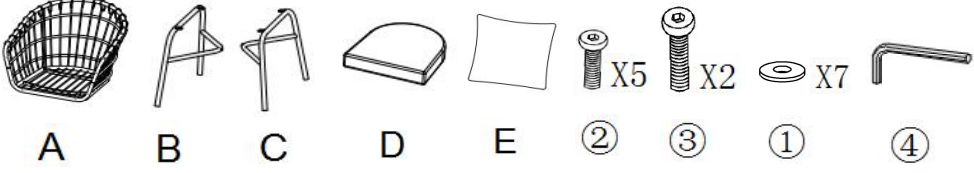
Label	Picture	Description	QTY
①		Washer	7
②		Bolt (M6*20mm)	5
③		Bolt (M6*30mm)	2
④		Alley Wrench	1

## Assembly Preparation

<p>Before Beginning Assembly:</p>	
-----------------------------------	--

-  • Read instructions, cover to cover-
-  • Have 2 adults on hand for assembly-
-  • Do not assemble on flooring or carpet-
-  • Assemble on a clean non-marring surface (packing foam)-
-  • Save all packaging until finished-

## Assembly Steps

### Overview

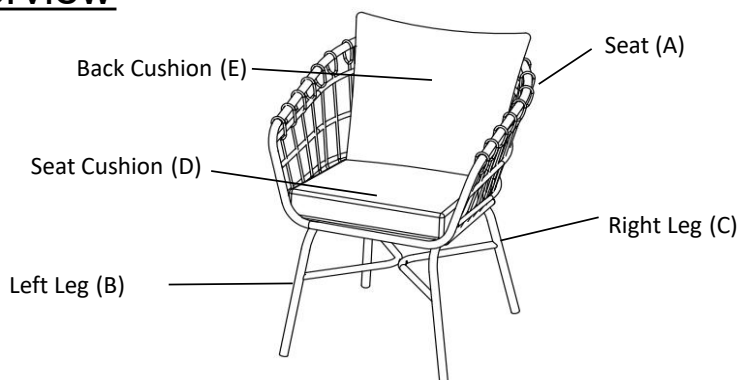

This Chair has multiple parts and may require up to 30 minutes to assemble. To give you an overview of the Chair parts, the above picture is to help you put the various parts into perspective. Please read through the instructions below to familiarise yourself with the parts and steps before assembly.

## Step 1

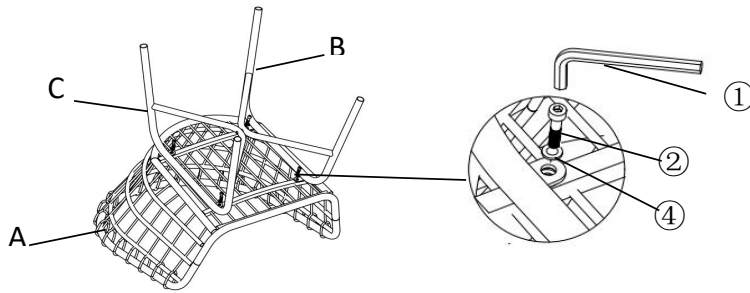

Open the carton, and place all parts onto a clean, non-marring surface.

Attach the Left Leg (B) to Seat (A) using Bolts (2) and Washers (1) with Allen Wrench (4) as shown above.

Attach the Right Leg (C) to Seat (A) using Bolts (2) and Washers (1) with Allen Wrench (4) as shown above.

**Do not fully tighten the Bolts.**

## Step 2

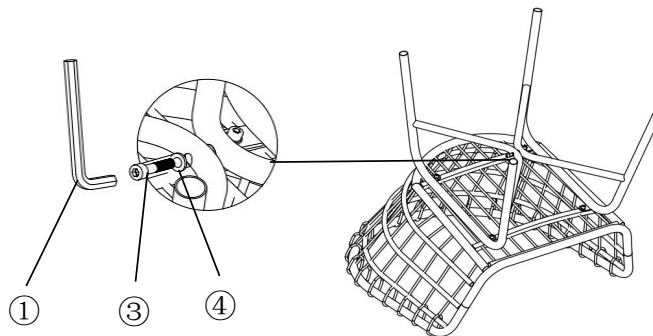

Attach the Right Leg (C) to Left Leg (B) using Bolts (3) and Washers (1) with Allen Wrench (4) as shown above.

**Tighten Bolts fully in a sequential manner after all Bolts are in place.**

## Step 3

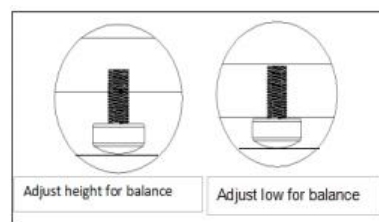
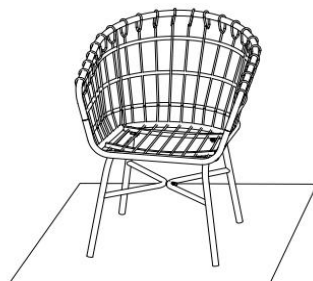

Stand the Chair up.

Place the Chair on a level surface to check for wobbles.

If the Chair wobbles, adjust the Levelers on the bottom of the Legs to make it level.

## Step 4

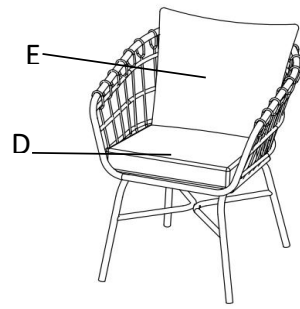

Stand the Chair up.

Place the Seat cushion (D) and Back Cushion (E) on the Chair.

The Chair is ready for use.

The Chair can only be used on a flat, level surface.

Your Chair is ready for use.

**The Chair can be only used on a flat, level surface.**