

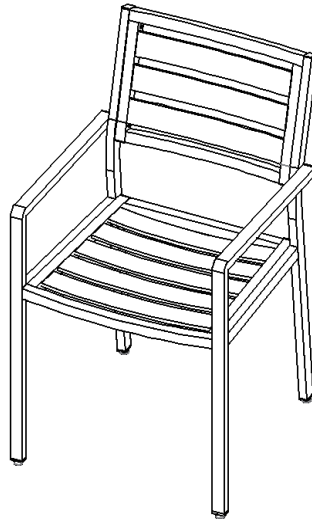



Assembly Instructions

Caution : You must read this before you proceed

Single Chair





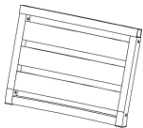



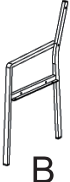

Parts List

Label	Picture	Description	QTY
A		Right Armrest/Leg	1
B		Left Armrest/Leg	1
C		Seat	1
D		Backrest	1

Hardware

Label	Picture	Description	QTY
①		Bolt (M6*15MM)	5
②		Bolt (M6*35MM)	9
③		Gasket	9
④		Allen Wrench	1
⑤		Plastic stopper	1

Assembly Preparation

<p>Before Beginning Assembly :</p>	   	 ① x 5  ② x 9  ③ x 9  ④  ⑤
---	---	--



- Read instructions, cover to cover-



- Have 2 adults on hand for assembly-



- Do not assemble on flooring or carpet-



- Assemble on a clean non-marring surface (packing foam)-



- Save all packaging until finished-

Assembly Steps

Overview

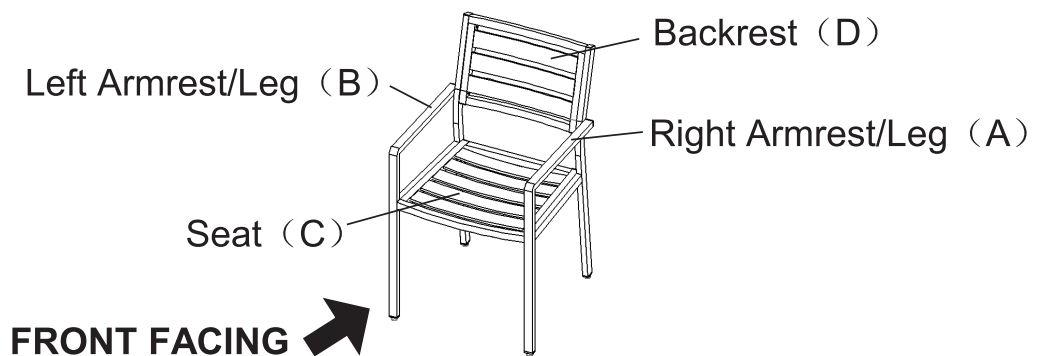

This Single Chair has multiple parts and may require up to 30 minutes to assemble. To give you an overview of the Single Chair parts, the above picture is to help you put the various parts into perspective. Please read through the instructions below to familiarise yourself with the parts and steps before assembly.

Step 1

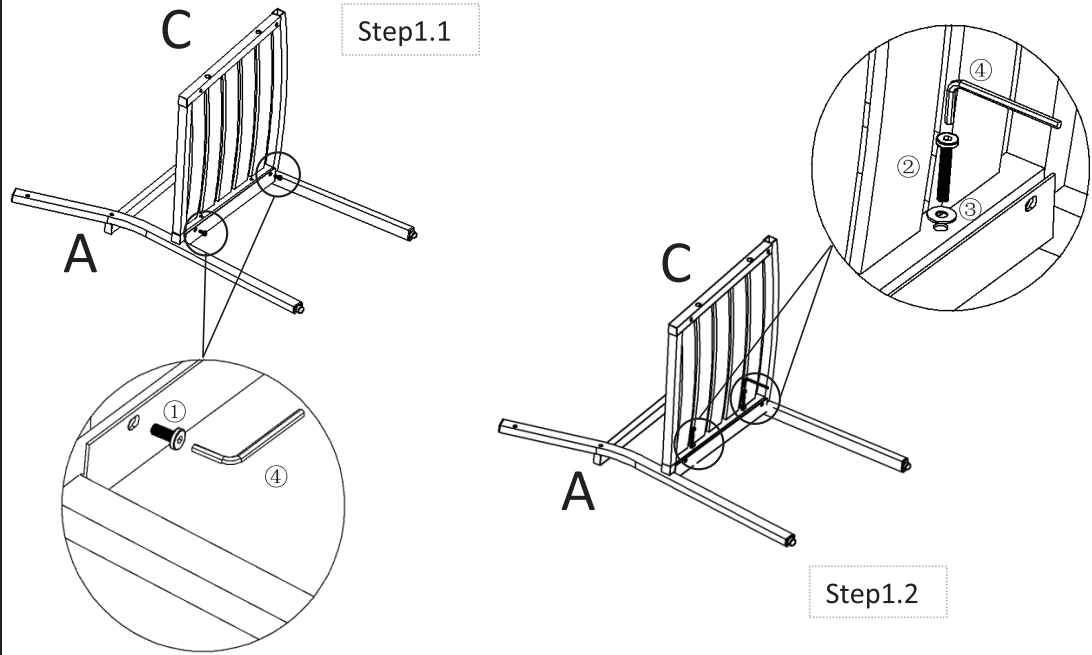

Open the carton and place all the parts onto a clean, non-marring surface.

1.1) Attach the Seat (C) to the Right Armrest/Leg (A) using Bolts (1) with the Allen Wrench (4) as shown above.

1.2) As shown above in figure 1.2, further attach the seat (C) to the right armrest/seat leg (A) using bolts (2) and gaskets (3) with the Allen Wrench (4).

Do not fully tighten the Bolts.

Step 2

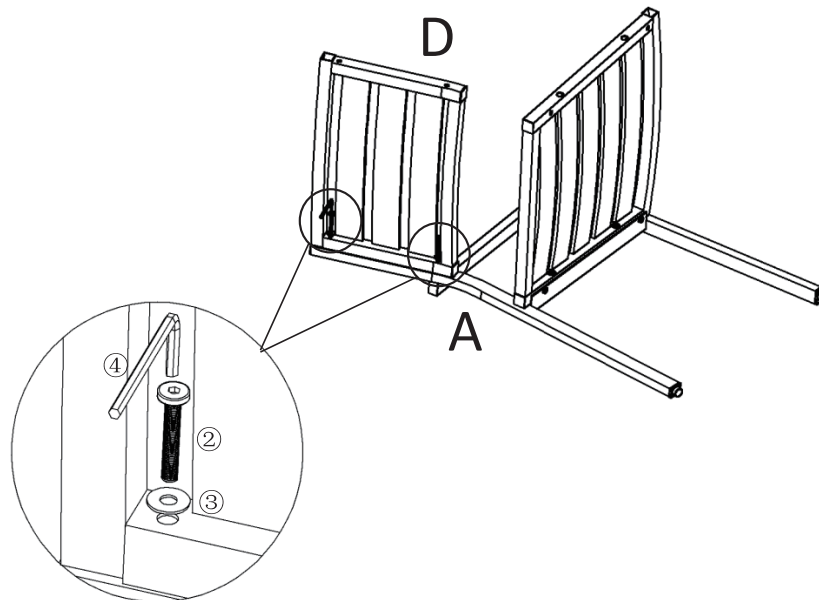

Attach the backrest (D) to the right handrail and the leg (A) using bolts (2) and gaskets (3) with the Allen Wrench (4) as shown above.

Do not fully tighten the Bolts.

Step 3

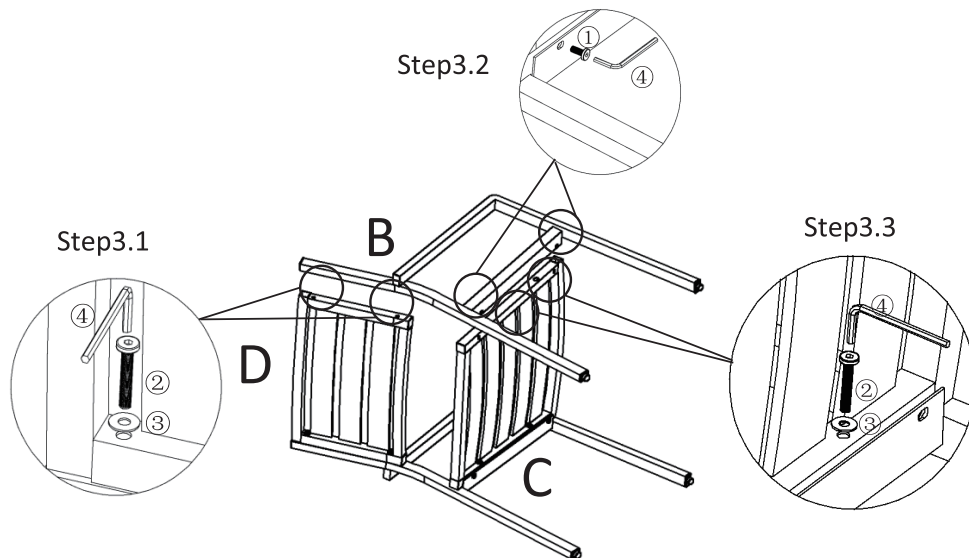

3.1) Use bolts (②) and gaskets (③) with the Allen Wrench (④) to attach the left armrest/leg (B) to the backrest on the chair (D) as shown above in figure 3.1.

3.2) Further Attach the Left Armrest/Leg(B) to the Seat(C) using Bolts(①) with the Allen Wrench(④) as shown above in figure 3.2.

3.3) To complete the attachment of the left armrest/leg (B) to the seat (C) use bolts (②) and gaskets (③) with the Allen Wrench (④) as shown above in figure 3.3

Do not fully tighten the Bolts.

Step 4

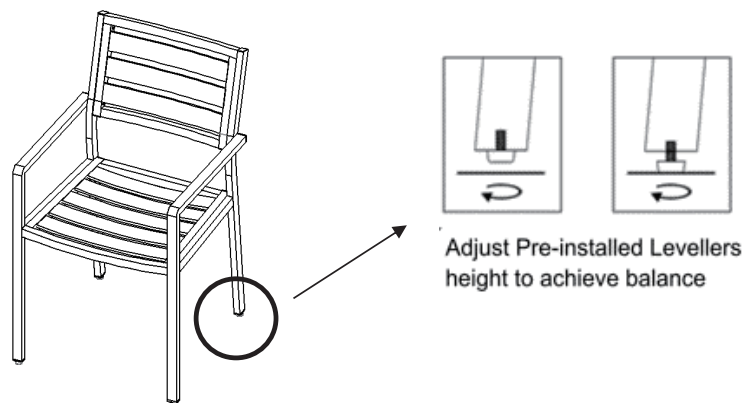

Stand the Chair up. Place the Chair on a LEVEL SURFACE.

Inspect it and make sure all parts are adequately connected. Gently and carefully, sit onto the Chair. This will help to align all parts at all joints. Then get off the Chair, and in a sequential manner, proceed to tighten all Bolts.

When tightening the Bolts, tighten sequentially.





















DO NOT tighten any Bolt fully and then move on to the next one. This may cause the frame to warp. If there are any wobbles after tightening, loosen the Bolts and execute the same process.

If the Chair is not stable it could lead to damage of the product.

Your Chair is ready for use.

This Chair can only be used on a flat and level surface.

Care & Maintenance

-   ● Do not put hot items directly on furniture surface
 -   ● Do not clean furniture with harsh cleansers or polish.
 -   ● To obtain the longest lifespan of your outdoor products, minimizing exposure to direct sunlight is recommended.
 -   ● Children should not climb or jump on the furniture.
 -   ● Do not write on furniture without a padded barrier to protect the surface.
 -   ● To obtain the longest lifespan of your outdoor products, avoid extended and lengthy exposure to rain, snow, and direct sunshine. Whenever possible cover the product and /or place under patio or awnings.
 -   ● Not for commercial use. For residential use only .
 -   ● Stains may be removed with mild soap solution and damp cloth.
 -   ● Keep away from sources of ignition.
-
-   ● Dust and pick-up spills using a clean, non-colored, lint-free cloth.