

# Assembly Instructions

Caution: You must read this before you proceed



## Dining Table



### Part List

Label	Picture	Description	QTY
A	A line drawing of the table top, showing its rectangular shape and slightly beveled edges.	Table Top	1
B	A line drawing of a single table leg, showing its tapered shape and a small notch at the bottom.	Table Leg	4

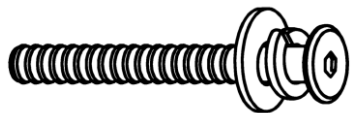
# Hardware

Label	Picture	Description	QTY
①		JCBB Bolt Set (M8x80mm)	9
②		Allen Key	1

# Assembly Preparation

Before Beginning Assembly:

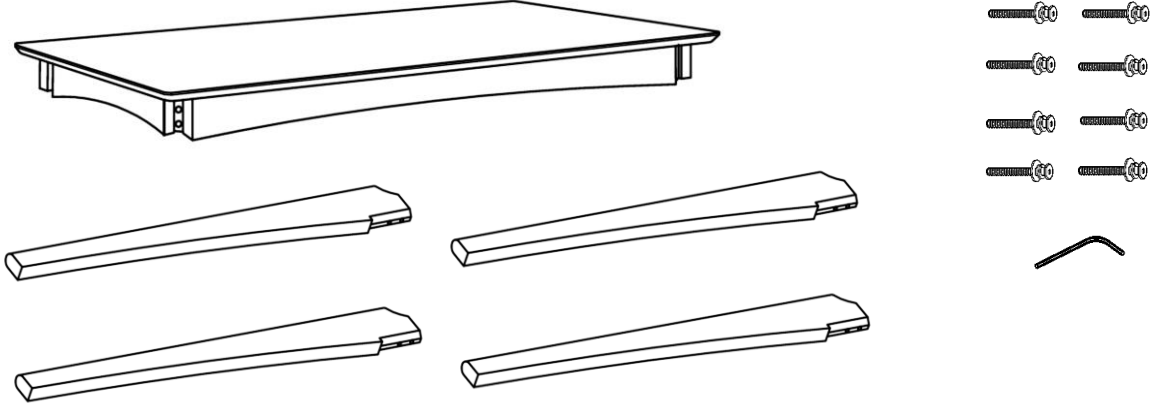

- Read instructions, cover to cover-



- Have 2 adults on hand for assembly-



- Do not assemble on flooring or carpet-



- Assemble on a clean non-marring surface (packing foam)-



- Save all packaging until finished-

# Assembly Steps

## Overview

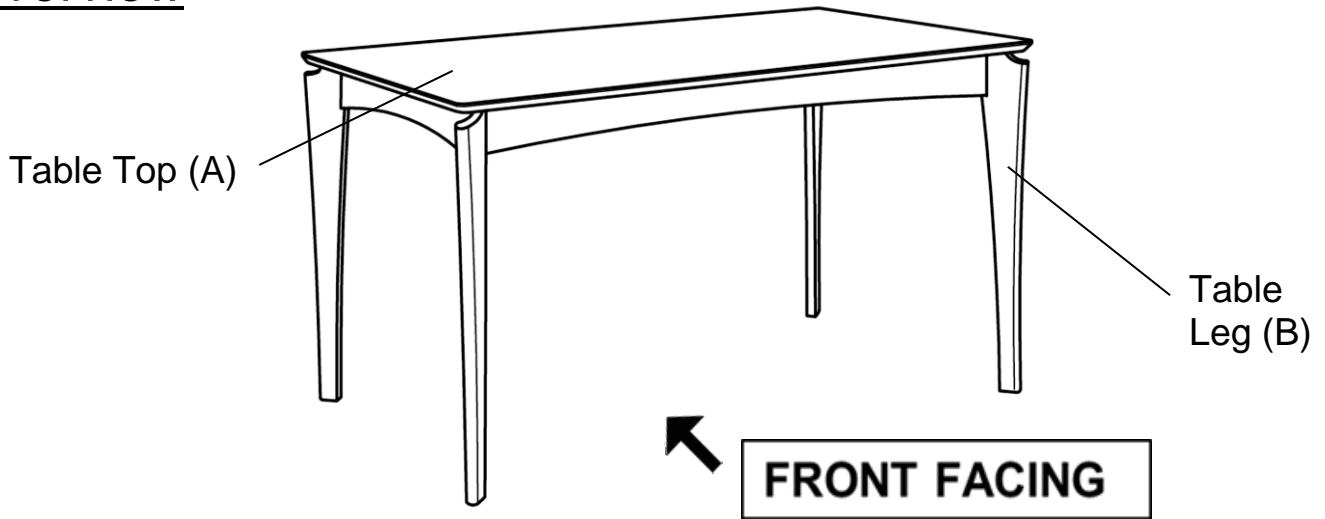

This Dining Table has multiple parts and may require up to 30 minutes to assemble. To give you an overview of the Dining Table parts, the above picture is to help you put the various parts into perspective. Please read through the instructions below to familiarise yourself with the parts and steps before assembly.

## Step 1

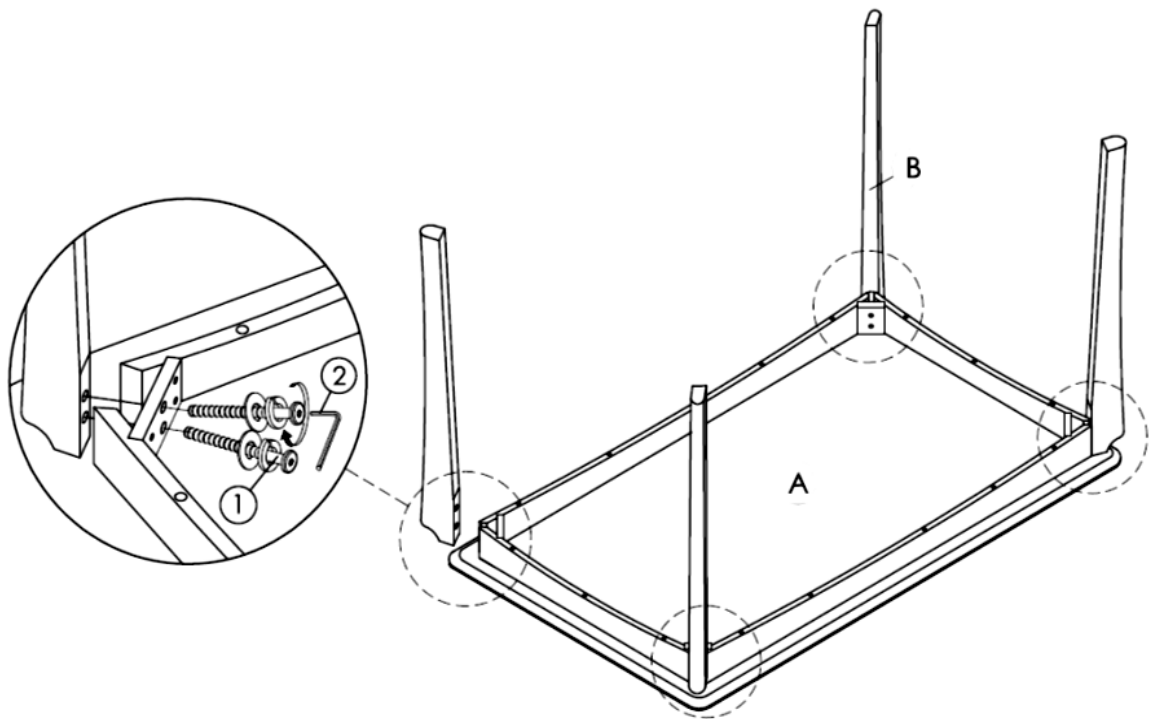

**Note: The Table and its parts are heavy, two adults are required whenever lifting and moving them.**

Place the Table Top(A) facedown onto a clean, non-marring surface.

Align the Table Legs(B) to Table Top(A).

Attach Table Legs(B) to Table Top(A) using JCBB Bolt Sets(①) with Allen Key(②).

**Do not fully tighten the Bolts.**

## Step 2

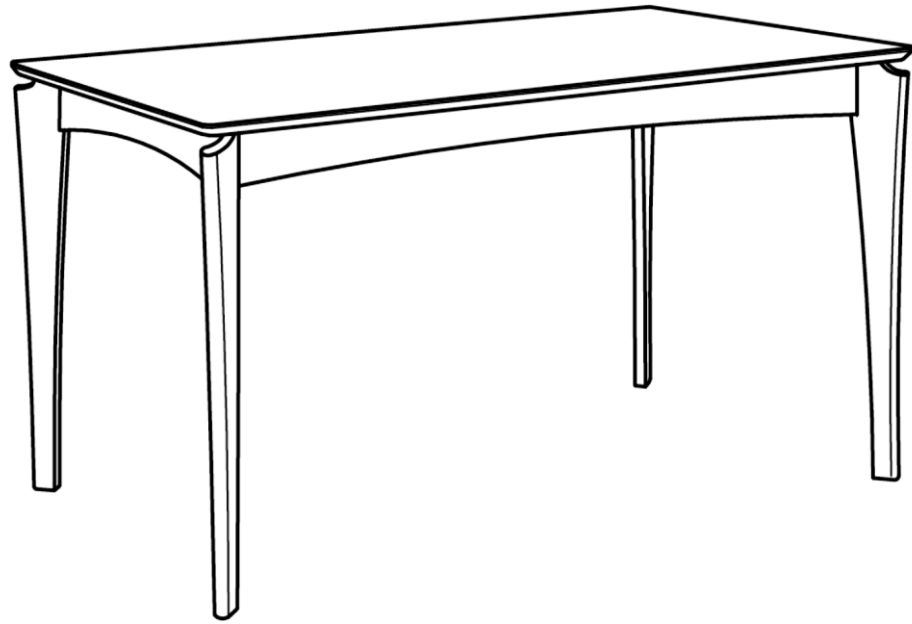

Stand the Table up, with assistance from your adult partner.

Exert pressure floorwards, onto the Table with both your hands.

This pressure will help the Legs and Table Top reach full alignment status.

Check for wobbles on a LEVEL surface.

If no wobbles are found proceed to tighten the Bolts in a sequential manner, until evenly secured.

**When tightening the Bolts tighten sequentially.**



















**Do not tighten any Bolt fully and then move on towards the next one.**



**If there are still wobbles, loosen the Bolts and excute the same above process.**

Your Dining Table is now ready for use.

**This Dining Table can only used on a flat, level surface.**

# Care & Maintenance

-   ● Do not put hot items directly on furniture surface
-   ● Do not clean furniture with harsh cleansers or polish.
-   ● Do not place furniture under direct sunlight.
-   ● Do not place furniture near heating or cooling vents.
-   ● Do not write on furniture without a padded barrier to protect the surface.
-   ● Do not place furniture outside . For indoor use only .
-   ● Not for commercial use. For residential use only .
-   ● Stains may be removed with mild soap solution and damp cloth.
-   ● Children should not climb or jump on the furniture.

- 
-   ● Dust and pick-up spills using a clean, non-colored, lint-free cloth .