

Assembly Instructions

Caution : You must read this before you proceed

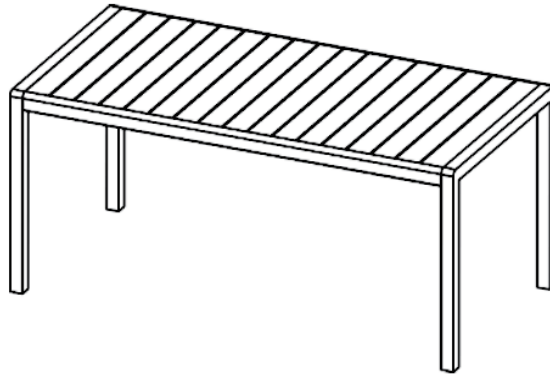



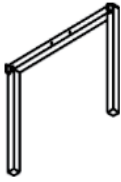
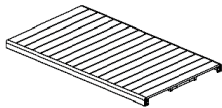

Table



Parts List

Label	Picture	Description	QTY
A		Leg	2
B		Table Top	1

Hardware

Label	Picture	Description	QTY
①		Bolt(M6*20MM) Flat Head	5
②		Bolt(M6*25MM) Flat Head	5
③		Bolt(M6*20MM) Round Head	9
④		Washer	9
⑤		Allen Wrench(4MM)	1
⑥		Allen Wrench(5MM)	1

Assembly Preparation

Before Beginning Assembly :

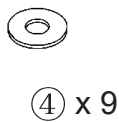
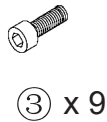
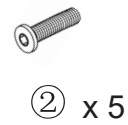
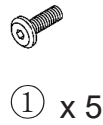
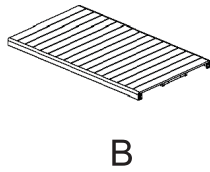
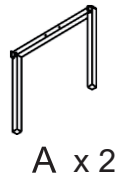

- Read instructions, cover to cover-



- Have 2 adults on hand for assembly-



- Do not assemble on flooring or carpet-



- Assemble on a clean non-marring surface (packing foam)-



- Save all packaging until finished-

Assembly Steps

Overview

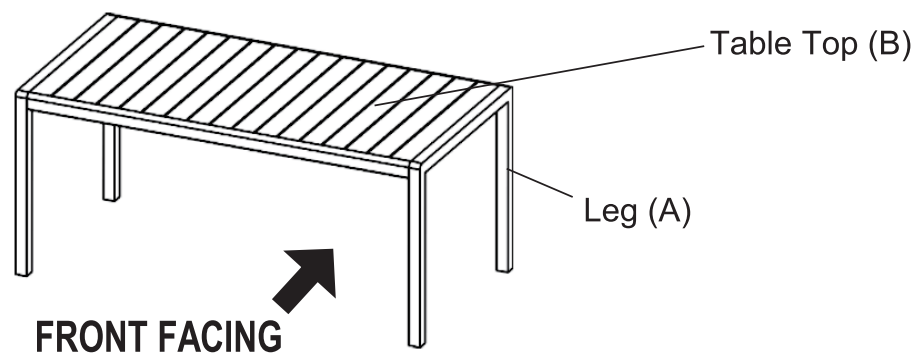

This Table has multiple parts and may require up to 30 minutes to assemble. To give you an overview of the Table parts, the above picture is to help you put the various parts into perspective. Please read through the instructions below to familiarise yourself with the parts and steps before assembly.

Step 1

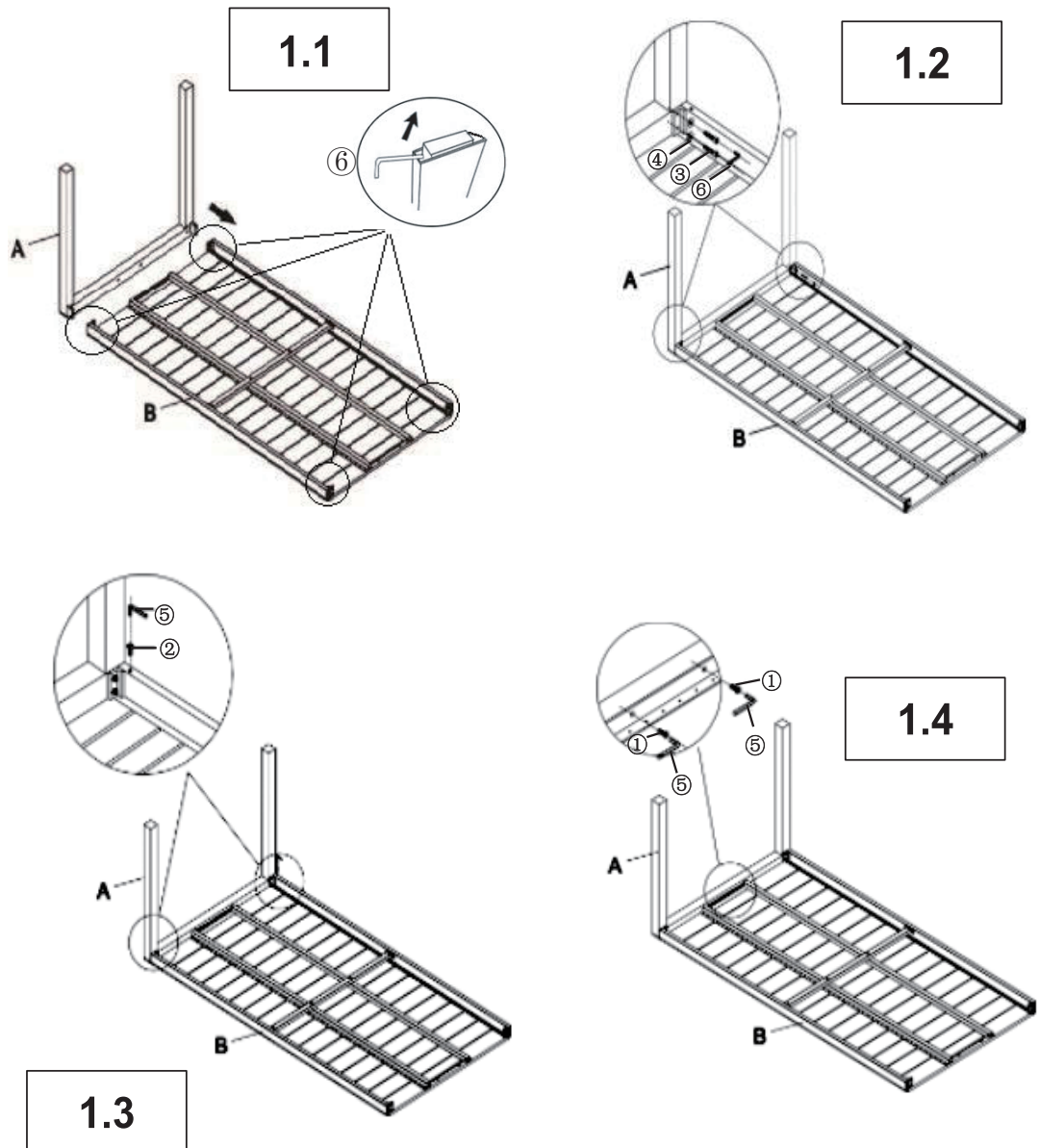

Open the carton and place all the parts onto a clean, non-marring surface.

1.1) As shown above, use an Allen wrench (6) to remove the four ends of the Table Top (B) plastic plug (to prevent the aluminum tube from being scratched). Insert Leg into Table Top (B).

1.2) Attach Leg (A) to Table Top (B) using Bolts (3) and Washers (4) with Allen wrench (6) as shown above.

1.3) Attach Leg (A) to Table Top (B) using Bolts (2) with Allen wrench (5) as pictured.

1.4) Attach Leg (A) to Table Top (B) using Bolts (1) with Allen wrench (5) as shown above.

Do not fully tighten the Bolts.

Step 2

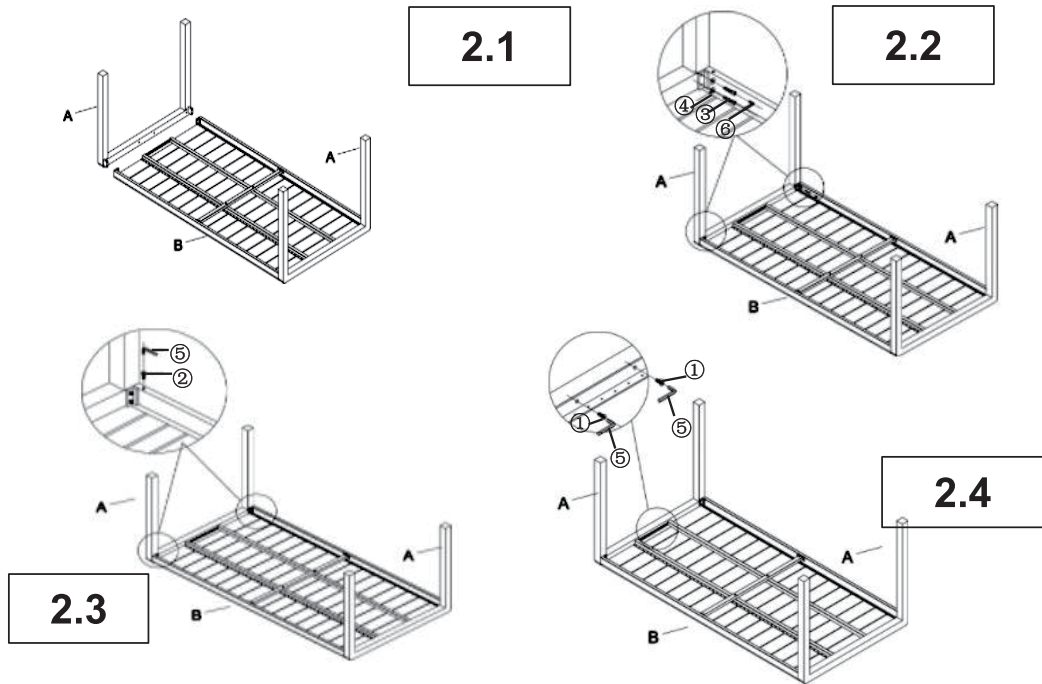

2.1) Insert Leg into Table Top(B).

2.2) Attach Leg(A) to Table Top(B) using Bolts(③) and Washers(④) with Allen wrench(⑥) as shown above.

2.3) Attach Leg(A) to Table Top(B) using Bolts(②) with Allen wrench(⑤) as pictured.

2.4) Attach Leg(A) to Table Top(B) using Bolts(①) with Allen wrench(⑤) as shown above.

Do not fully tighten the Bolts.

Step 3

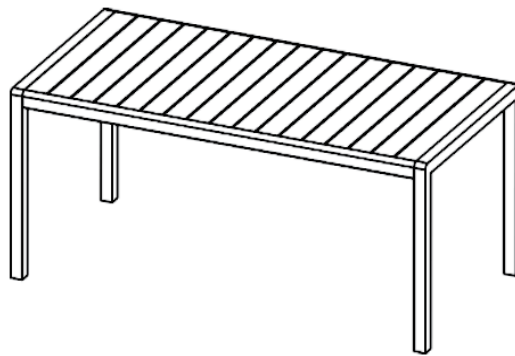

Stand the Table up, with assistance from your adult partner.

Exert pressure floorwards, onto the Table with both your hands.

This pressure will help the Legs and Table Top reach full alignment status.

Check for wobbles on a LEVEL surface.

If no wobbles are found proceed to tighten the Bolts in a sequential manner, until evenly secured.

When tightening the Bolts tighten sequentially.

Do not tighten any Bolt fully and then move on towards the next one.





















If there are still wobbles, loosen the Bolts and execute the same above process.

If the Table is not Stable it could lead to damage to the product.

Your Table is ready for use.

This Table can only be used on a flat, level surface.

Care & Maintenance

-   ● Do not put hot items directly on furniture surface
 -   ● Do not clean furniture with harsh cleansers or polish.
 -   ● To obtain the longest lifespan of your outdoor products, minimizing exposure to direct sunlight is recommended.
 -   ● Children should not climb or jump on the furniture.
 -   ● Do not write on furniture without a padded barrier to protect the surface.
 -   ● To obtain the longest lifespan of your outdoor products, avoid extended and lengthy exposure to rain, snow, and direct sunshine. Whenever possible cover the product and /or place under patio or awnings.
 -   ● Not for commercial use. For residential use only .
 -   ● Stains may be removed with mild soap solution and damp cloth.
 -   ● Keep away from sources of ignition.
-
-   ● Dust and pick-up spills using a clean, non-colored, lint-free cloth.