

# Assembly Instructions

**Caution: You must read this before you proceed**

## Chair

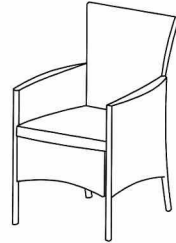

### Parts List

Label	Picture	Description	QTY
A	A line drawing of the backrest part of the chair, showing its curved shape and a small rectangular cutout at the bottom.	Backrest	1
B	A line drawing of the seat part of the chair, showing its rectangular shape and a small rectangular cutout at the bottom.	Seat	1
C	A line drawing of the left armrest and leg part of the chair, showing its curved shape and a small rectangular cutout at the bottom.	Left Armrest/Leg	1
D	A line drawing of the right armrest and leg part of the chair, showing its curved shape and a small rectangular cutout at the bottom.	Right Armrest/Leg	1
E	A line drawing of the seat cushion part of the chair, showing its rectangular shape.	Seat Cushion	1

### Hardware

Label	Picture	Description	QTY
①	A line drawing of a bolt, showing its hexagonal head and threaded shaft.	Bolt (M6*35mm)	11
②	A line drawing of a washer, showing its circular shape and a central hole.	Washer	11
③	A line drawing of an Allen wrench, showing its L-shaped profile.	Allen wrench	1

# Assembly Preparation

Before Beginning Assembly:

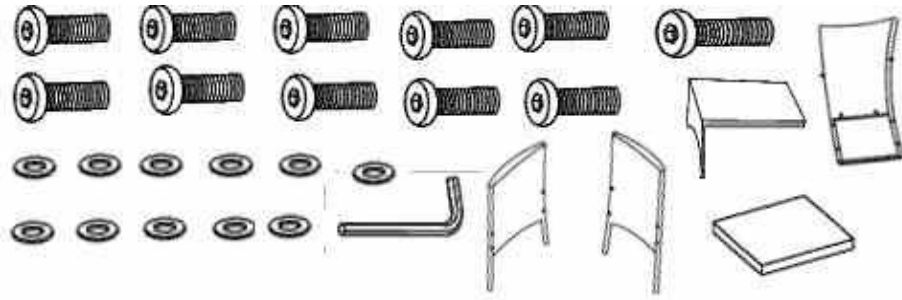

- Read instructions, cover to cover-



- Have 2 adults on hand for assembly-



- Do not assemble on flooring or carpet-



- Assemble on a clean non-marring surface (packing foam)-



- Save all packaging until finished-

# Assembly Steps

## Overview

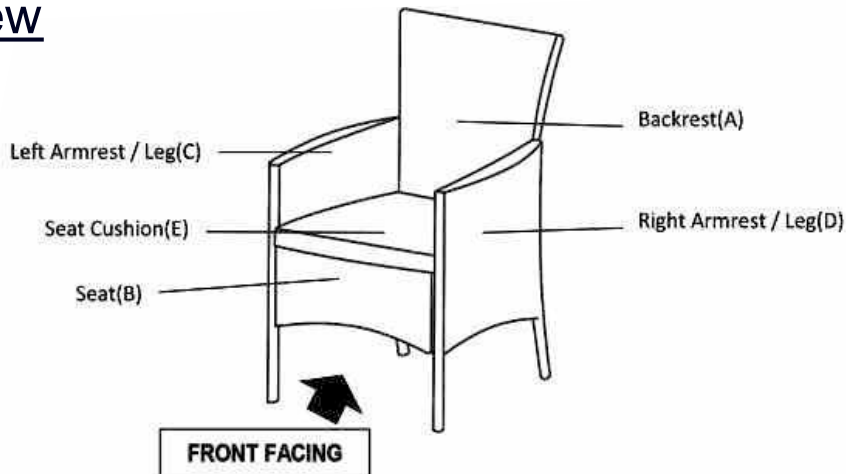

This Chair has multiple parts and may require up to some 30 minutes to assemble. To give you an overview of the Chair parts, the above picture is to help you put the various parts into perspective. Please read through the instructions here below to familiarise yourself with the parts and steps before assembly.

## Step 1

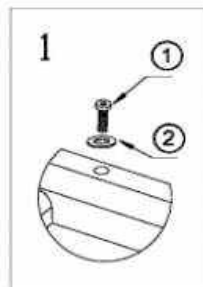
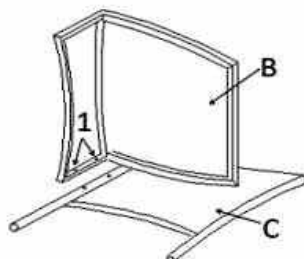

Open the carton and place all the parts onto a clean and soft surface.  
 Unpack all packages of hardware.  
 Attach Seat (B) to Left Armrest/Leg(C) using Bolts (①) and Washers (②) with **Allen wrench** (③) as shown in Picture.  
**DO NOT FULLY TIGHTEN THE BOLTS.**  
**ATTENTION: Occasionally some of the PE Wicker shifts and covers the mounting position preventing easy assembly.**  
**The PE wicker should never be cut, but moved away from the mounting positions.**

### Step 2

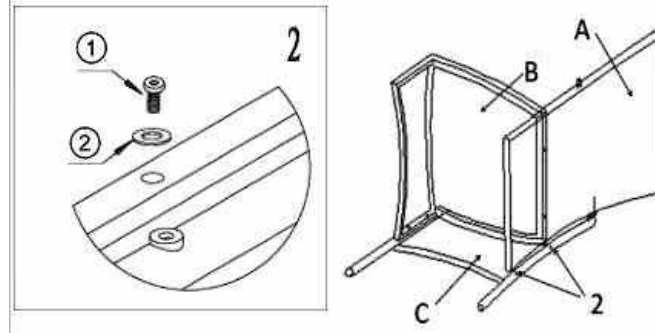

Attach the Backrest (A) and Left Armrest/Leg (C) together using Bolts (①) and Washers (②) with **Allen wrench** (③) as shown in Picture.

**DO NOT FULLY TIGHTEN THE BOLTS.**

### Step 3

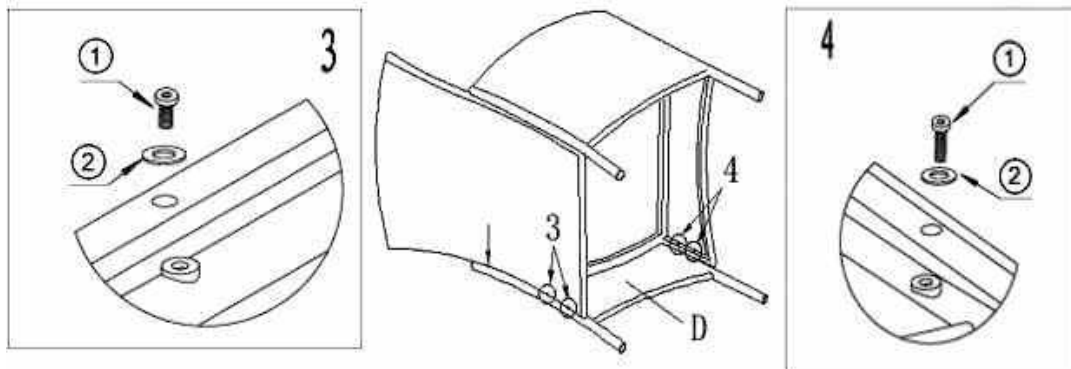

Place the Right Armrest/Leg (D) as pictured above and affix to the Backrest (A) and Seat (B) using Hardware (①&②) with **Allen wrench** (③) as shown in picture 3 and 4

**DO NOT FULLY TIGHTEN THE BOLTS.**

### Step 4

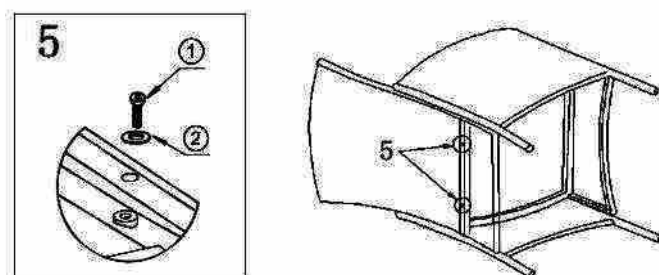

Align the mounting positions of the Seat (B) onto Backrest (A)  
If the mounting position not line up enough,can slightly shake the Seat up and down.  
Attach the Backrest (A) to Seat (B) using Hardware ((1)&(2)) with Allen wrench ((3)) as shown above.  
**DO NOT FULLY TIGHTEN THE BOLTS.**

## Step 5

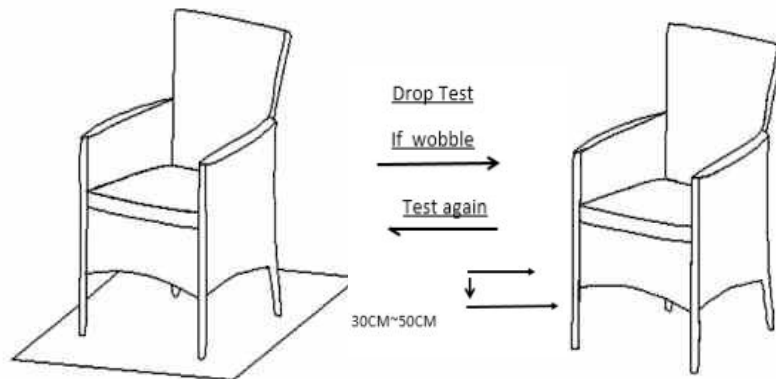





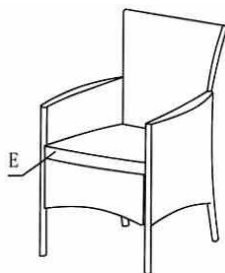





Stand CHAIR right side up.  
Check stability and then tighten the bolts.  
If it wobbles,lift the chair some 30cm to 50cm high from the ground.  
Keep your feet and toes well away from the drop zone.  
Drop the chair freely and vertically with all four legs,htting the ground,all at the same time.  
Test again for evenness on a LEVEL SURFACE.  
If no wobbles are found,slowly and steadily,place the chair facedown.  
Then, proceed to tighten all bolts in a sequential manner.  
When tightening any bolt, tighten sequentially.  
**Note:DO NOT fully tighten a BOLT in one go and then move on to the next.Rather,in a sequential manner,gradually tighten each Bolt until all bolts are evenly secured.This methodology will ensure maximum evenness once all Bolts are fully tightened.**

## Step 6



Put the Seat Cushion (E) on the Seat.  
Your Chair is ready for use.  
**The Chair can only be used on the flat and level surface.**

## Care & Maintenance

- ⊘  • Prolonged exposure to rain may cause rusting which can stain floors.
  - ⊘  • Do not put hot items directly on furniture surface.
  - ⊘  • Do not clean furniture with harsh cleansers or polish.
  - ✓  • To obtain the longest lifespan of your outdoor products, minimizing exposure to direct sunlight is recommended.
  - ⊘  • Children should not climb or jump on the furniture.
  - ⊘  • Do not write on furniture without a padded barrier to protect the surface.
  - ✓  • To obtain the longest lifespan of your outdoor products, avoid extended and lengthy exposure to rain, snow, and direct sunshine. Whenever possible cover the product and /or place under patio or awnings.
  - ⊘  • Not for commercial use. For residential use only.
  - ⊘  • Stains may be removed with mild soap solution and damp cloth.
  - ✓  • Keep away from sources of ignition.
- 
- ✓  • Dust and pick-up spills using a clean, non-colored, lint-free cloth.