

# Assembly Instructions



**Caution: You must read this before you proceed**

## Chaise

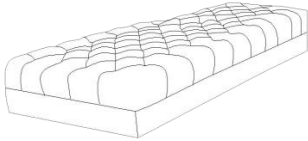
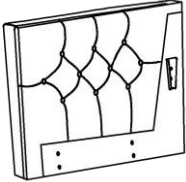

### Parts List

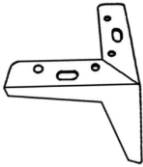
Label	Picture	Description	QTY(pc)
A		Chaise Back	1
B		Chaise Seat Base	1
C		Left Arm	1

D		Metal Leg	4
E		Middle Leg with 1 Plastic Gasket	2

## Hardware List

Label	Picture	Description	QTY
①		Plastic Gasket	2
②		Allen Key	1
③		Spring Ring(Φ13mm)	17
④		Big Flat Washer(Φ30mm)	8
⑤		Small Flat Washer(Φ22mm)	9
⑥		Bolt(M8*70mm)	8
⑦		Bolt(M8*30mm)	9

## Assembly Preparation

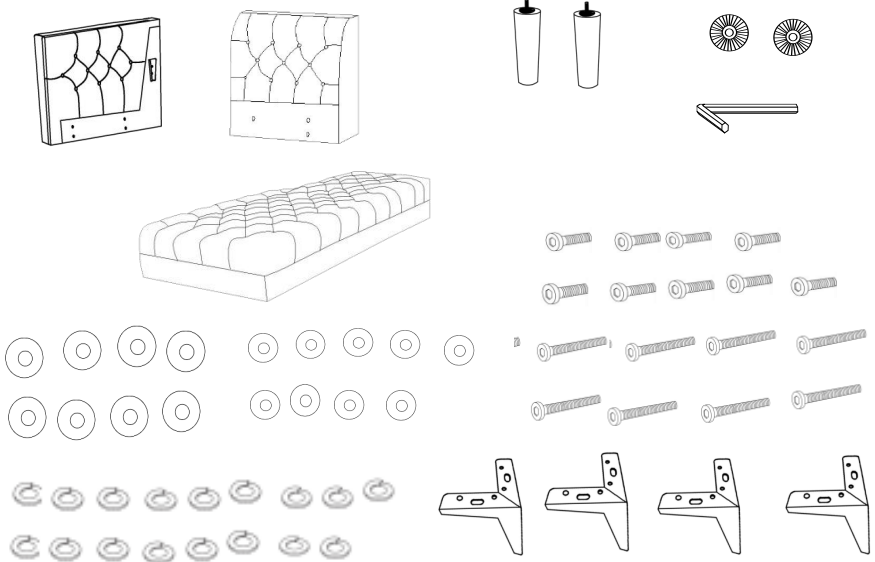
<p>Before Begining Assembly:</p>	
--	--



- Read instructions, cover to cover-



- Have 2 adults on hand for assembly-



- Do not assemble on flooring or carpet-



- Assemble on a clean non-marring surface (packing foam)-



- Save all packaging until finished-

## Assembly Steps

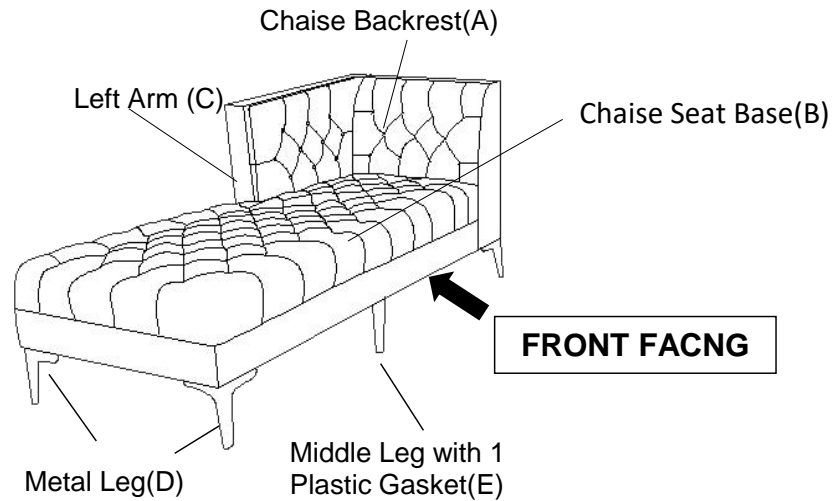

This Chaise has multiple parts and may require about 30 minutes to assemble. To give you an overview of the Sofa parts, the above picture is to help you put the various parts into perspective. Please read through the instructions below to familiarise yourself with the parts and steps before assembly.

### Step 1

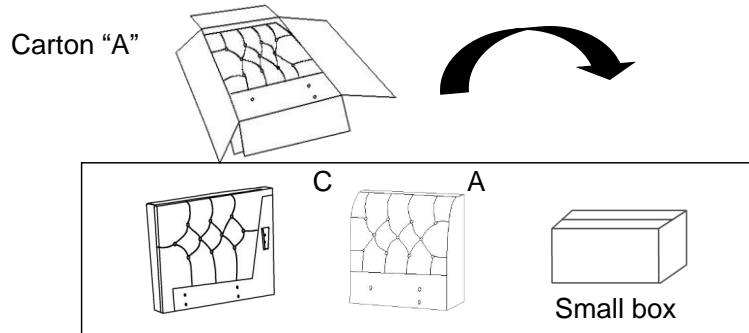

Take the Chaise Backrest(A), Left Arm(C) and Small Box out from carton "A" and place them on a clean, non-marring surface.

### Step 2

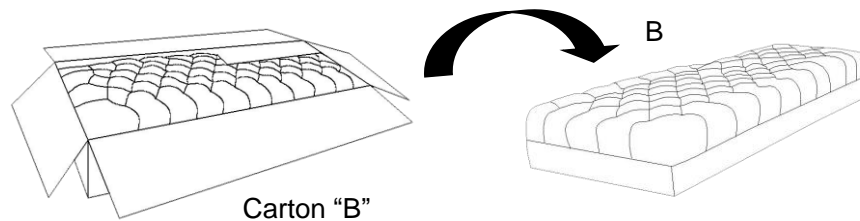

Take the Chaise Seat Base(B) from carton "B" and place it on a clean, non-marring surface.

**Step 3**

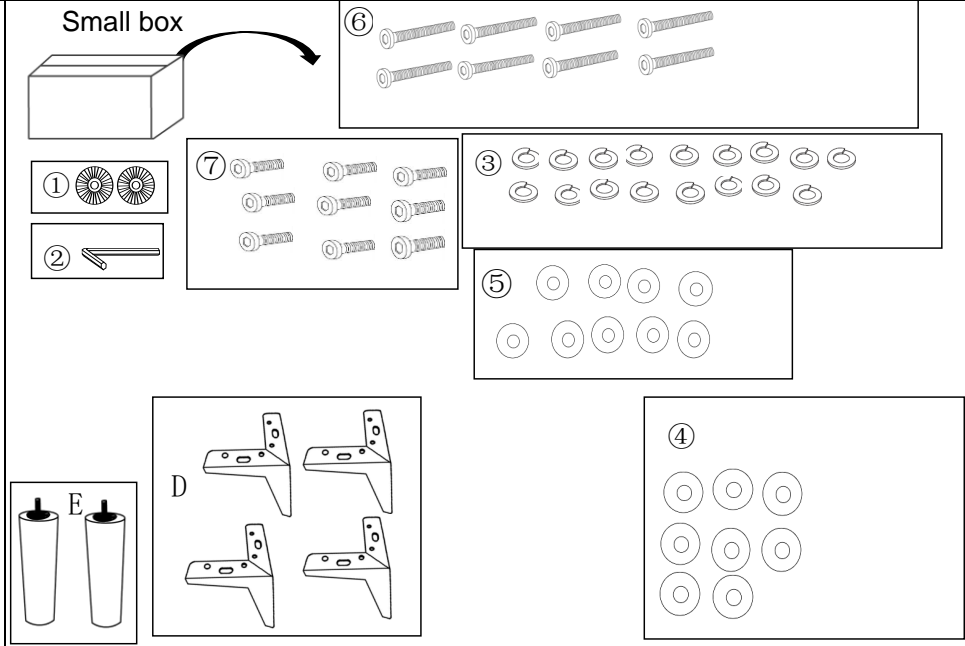

Open the Small Box to take out the Hardware and Legs as above.

**Step 4**

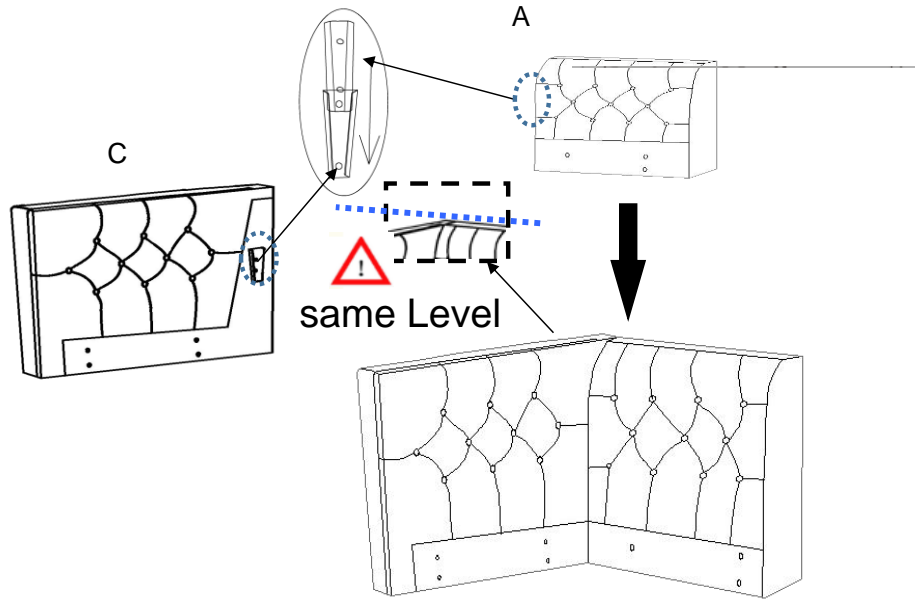

With assistance from your adult partner, align the mounting brackets on the Chaise Backrest(A) with those on the Left Arm(C). Then slide the Chaise Backrest(A) downwards to make sure it locks into place as pictured. Please squeeze the armrest properly against the backrest to ensure that the inserts can be assembled smoothly.

**Step 5**

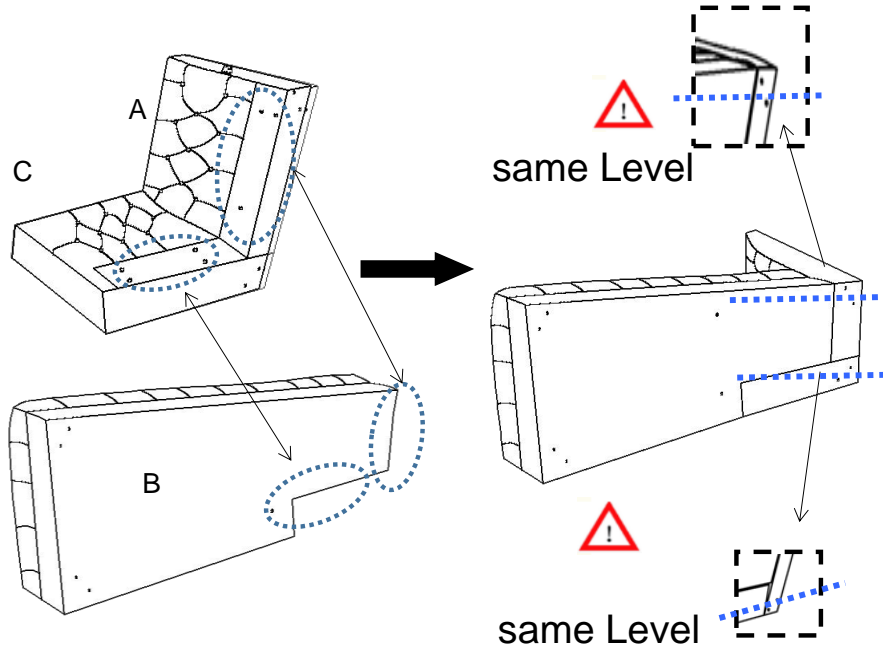

With assistance from your adult partner, align the mounting position on the back and Left side of the Chaise Seat Base(B) to the mounting position of the Chaise Backrest(A) and Left Arm(C) as pictured above, make sure the bottom of the Left Arm(C), Chaise Backrest(A) and Chaise Seat Base(B) are at the same level.

### Step 6

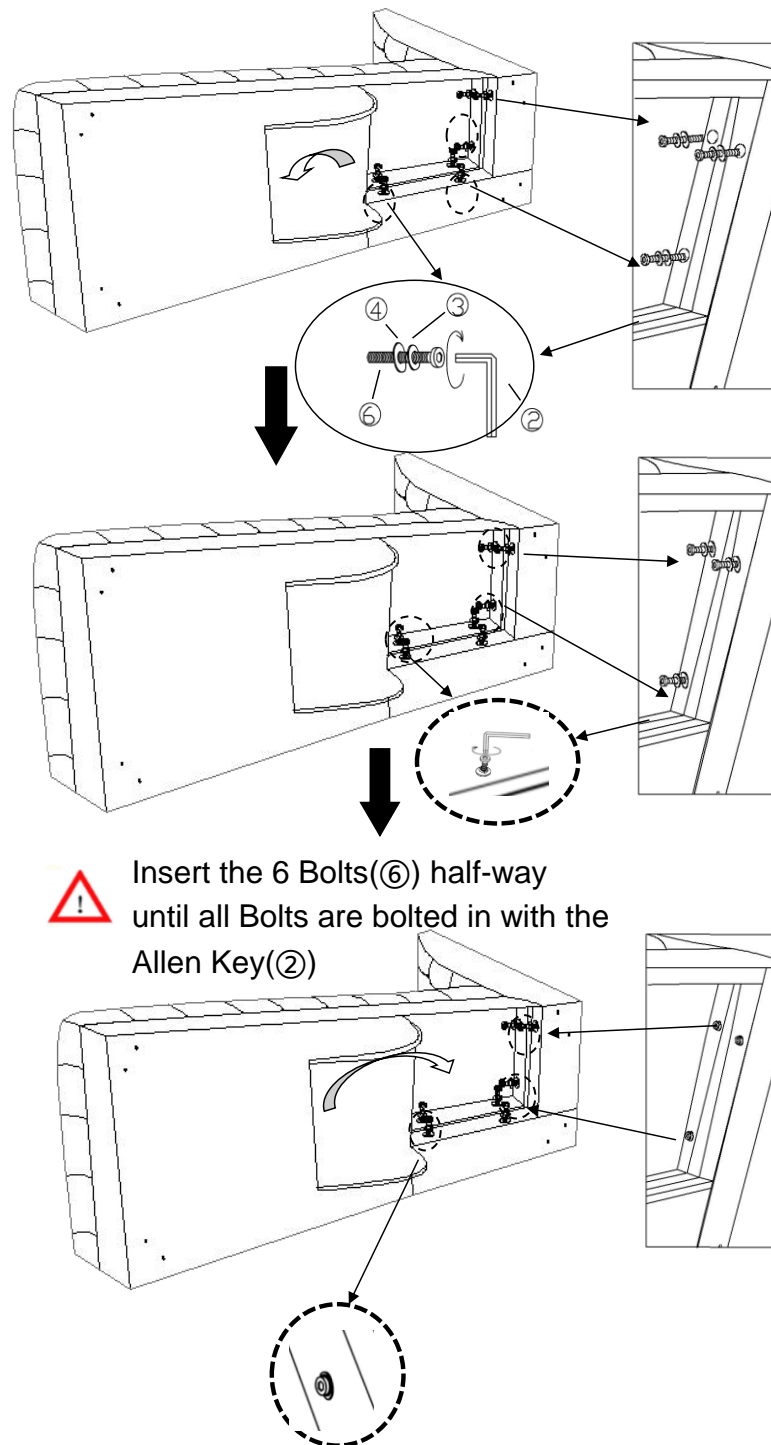

Open the Non-woven cover under the Chaise Seat Base(B).  
Using the Allen Key(②) secure the Chaise Seat Base(B) to the front-bottom of the Chaise Backrest(A) and the Left Arm(C) with Bolts(⑥), Spring Rings(③) and Big Flat Washers(④).  
Insert all the Bolts(⑥) half-way starting one by one as pictured.  
Then tighten the Bolts(⑥) with the Allen Key(②).  
Close the non-woven fabric under the Seat Base(B) with Velcro.

### Step 7

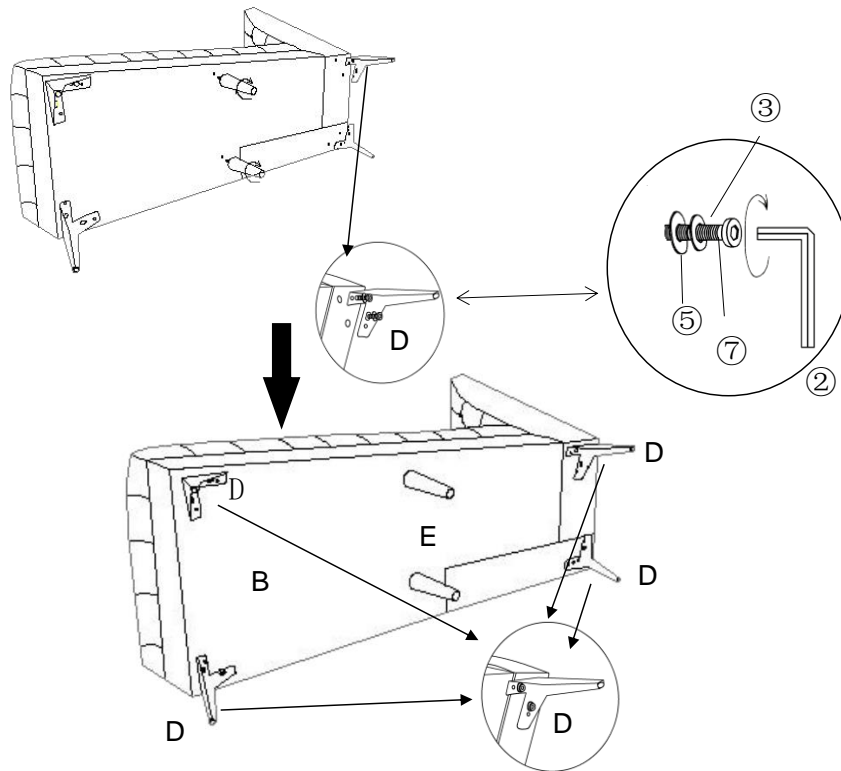























Carefully, Using the Allen Key(②), install the Metal Legs(D) at the bottom of Chaise Seat Base(B),Left Arm(C) and Chaise Backrest(A) with Spring Rings(③),Flat Small Washers(⑤) and Bolts(⑦), and then Install the Middle Leg with 1 Plastic Gasket(E) at the bottom of the Chaise Seat Base(B).

### Step 8



Now the Chaise is complete.  
Make sure all parts are connected and securely locked into position.  
Your Chaise is ready for use.  
This Chaise can only be used on a flat, level surface.

<b>Care &amp; Maintenance</b>	
 	• Furniture may scratch floors. We recommend using furniture pads to protect your floors.
 	• Do not put hot items directly on furniture surface.
 	• Do not clean furniture with harsh cleansers or polish.
 	• Do not place furniture under direct sunlight.
 	• Do not place furniture near heating or cooling vents.
 	• Do not write on furniture without a padded barrier to protect the surface.
 	• Do not place furniture outside . For indoor use only.
 	• Not for commercial use. For residential use only.
 	• Stains may be removed with mild soap solution and damp cloth.
 	• Children should not climb or jump on the furniture.
 	• Dust and pick-up spills using a clean, non-colored, lint-free cloth.

Questions & Answers about Proposition 65

- What is Proposition 65?  
 Proposition 65 requires businesses to provide warnings to Californians about significant exposures to chemicals that cause cancer, birth defects or other reproductive harm. These chemicals can be in the products that Californians purchase, in their homes or workplaces, or that are released into the environment. By requiring that this information be provided, Proposition 65 enables Californians to make informed decisions about their exposures to these chemicals. Proposition 65 also prohibits California businesses from knowingly discharging significant amounts of listed chemicals into sources of drinking water. Proposition 65 requires California to publish a list of chemicals known to cause cancer, birth defects or other reproductive harm. This list, which must be updated at least once a year, has grown to include approximately 900 chemicals since it was first published in 1987.
- What types of chemicals are on the Proposition 65 list?  
 The list contains a wide range of naturally occurring and synthetic chemicals that include additives or ingredients in pesticides, common household products, food, drugs, dyes, or solvents. Listed chemicals may also be used in manufacturing and construction, or they may be byproducts of chemical processes, such as motor vehicle exhaust.
- What does a warning mean?  
 If a warning is placed on a product label or posted or distributed at a workplace, a business, or in rental housing, the business issuing the warning is aware or believes that it is exposing individuals to one or more listed chemicals. By law, a warning must be given for listed chemicals unless the exposure is low enough to pose no significant risk of cancer or is significantly below levels observed to cause birth defects or other reproductive harm.
- Where can I get more information on Proposition 65?  
 If you have specific questions on the administration or implementation of Proposition 65, you can contact OEHHA's Proposition 65 program at [P65.Questions@oehha.ca.gov](mailto:P65.Questions@oehha.ca.gov), or by phone at (916) 445-6900.