

# ASSEMBLY INSTRUCTIONS



## Patio Table





SCAN FOR ASSEMBLY VIDEO AND ONLINE  
INSTRUCTION MANUAL

# This Patio Table includes the following:

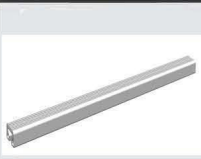

## Patio Table Assembly Parts

PART	DESCRIPTION	IMAGE	QUANTITY
TP	Table Top		1
SP	Side Panel		4
TB	Table Bottom		1
CNT	Connector		4

# Assembly

1

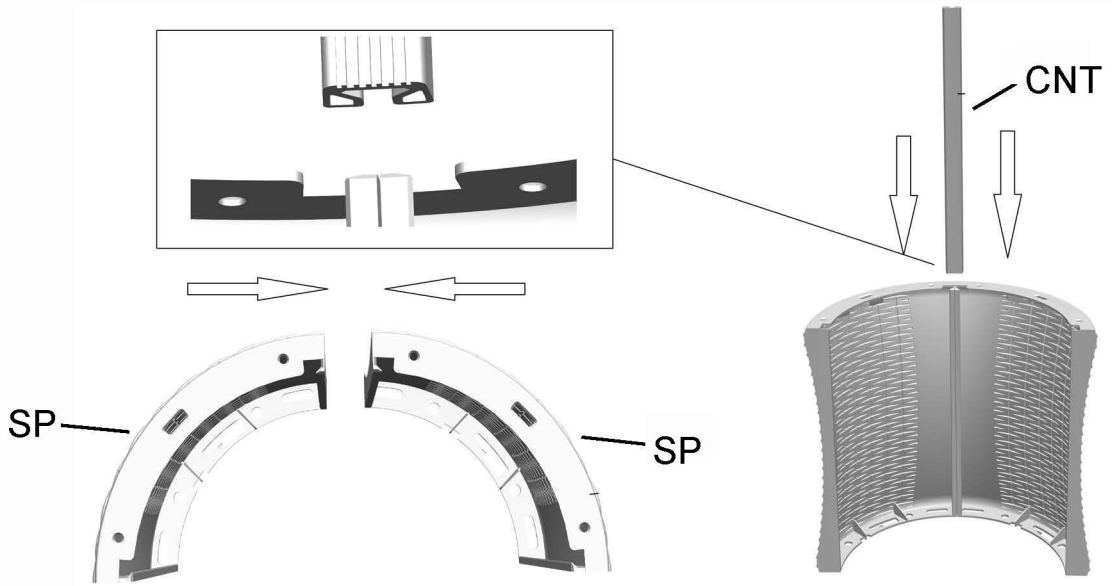

2

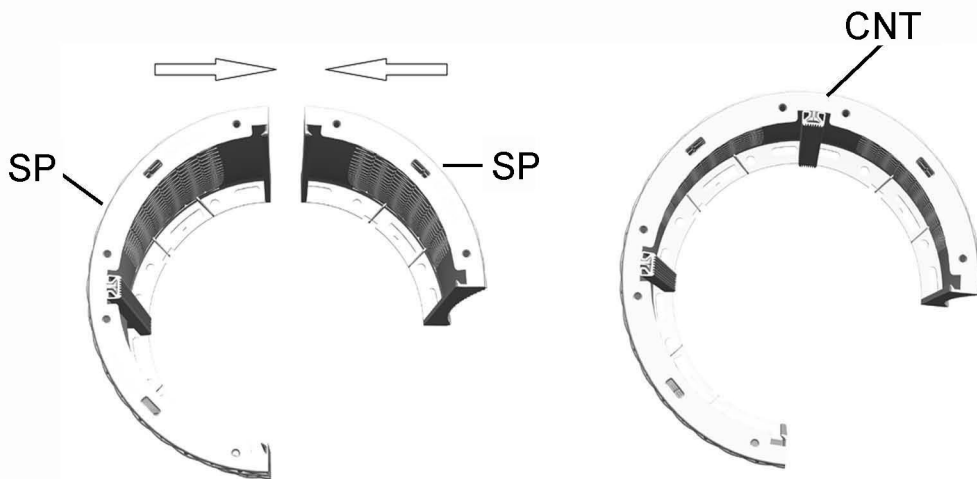

3

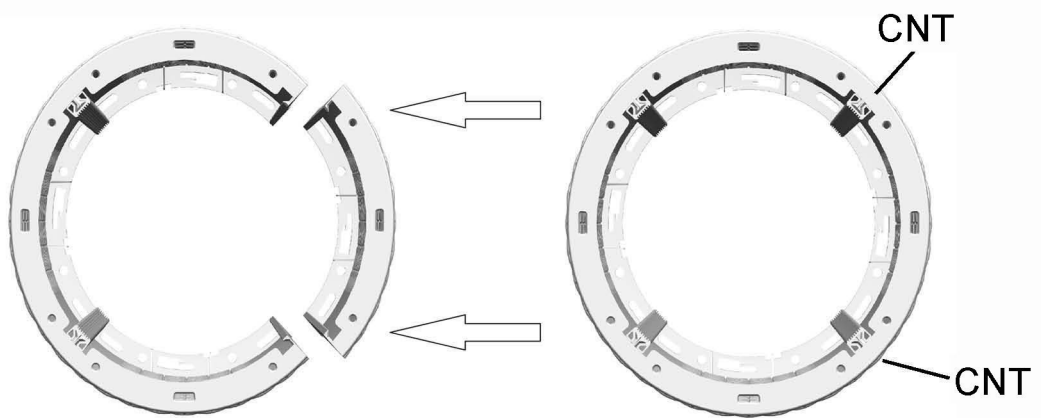

Step 2&3, repeat step 1 for rest 3 connectors.

4

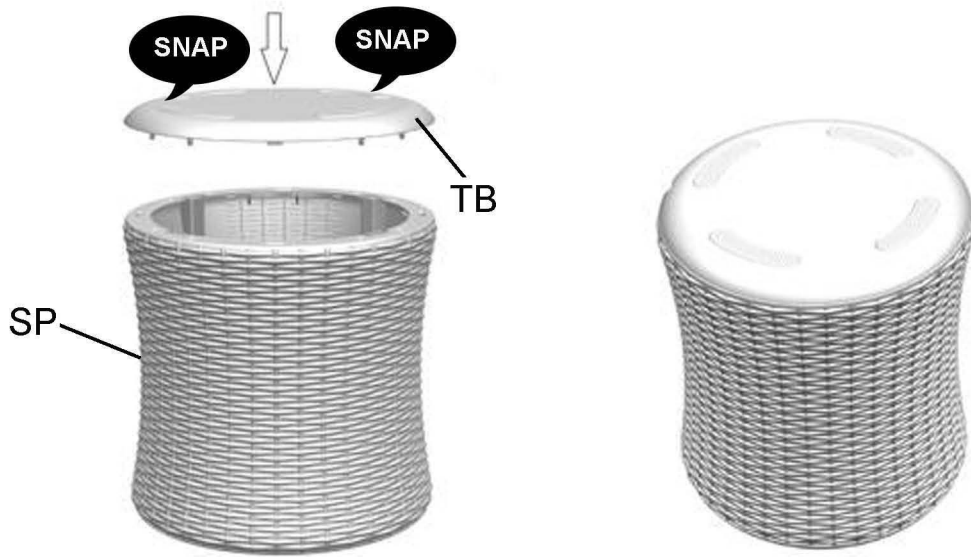

5

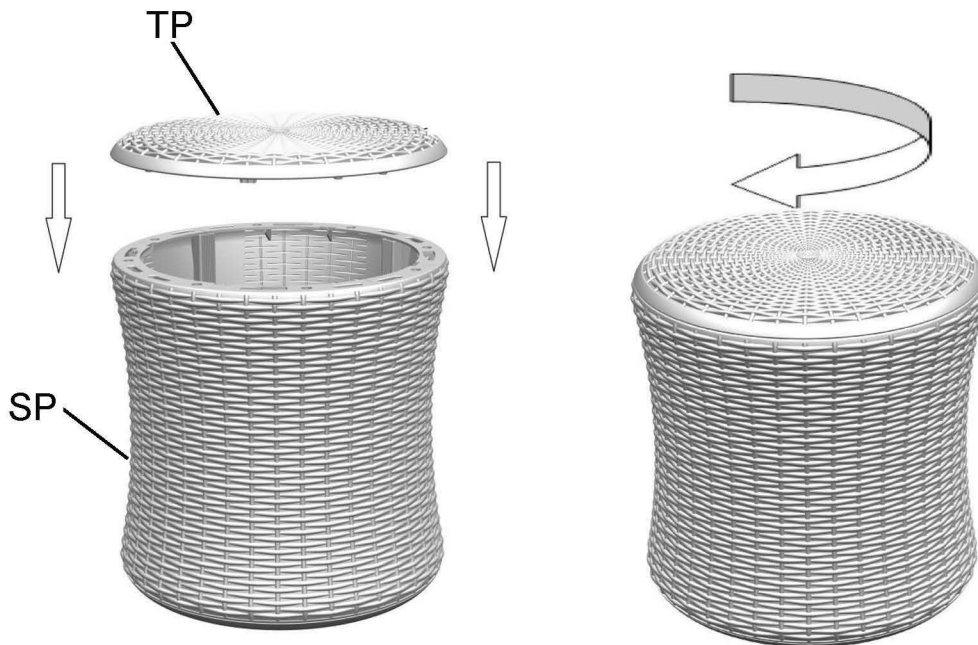

Close: According to the arrow direction to close the table top(TP).



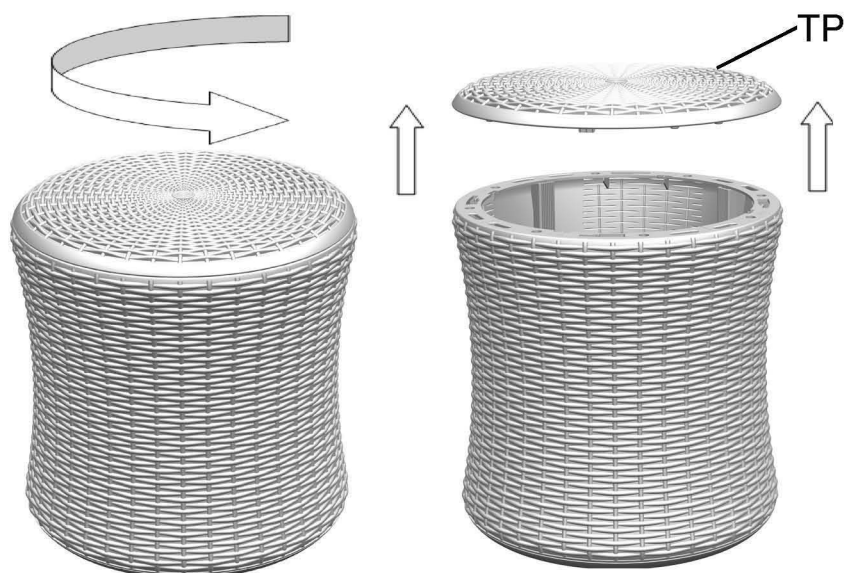







**6**



Open: According to the arrow direction to open the table top(TP).



## Care & Maintenance

- ⊘  ● Do not put hot items directly on furniture surface.
- ⊘  ● Do not clean furniture with harsh cleansers or polish.
- ✓  ● To obtain the longest lifespan of your outdoor products, minimizing exposure to direct sunlight is recommended.
- ⊘  ● Children should not climb or jump on the furniture.
- ⊘  ● Do not write on furniture without a padded barrier to protect the surface.
- ✓  ● To obtain the longest lifespan of your outdoor products, avoid extended and lengthy exposure to rain, snow, and direct sunshine. Whenever possible cover the product and /or place under patio or awnings.
- ⊘  ● Not for commercial use. For residential use only.
- ⊘  ● Stains may be removed with mild soap solution and damp cloth.
- ✓  ● Keep away from sources of ignition.
- ✓  ● Dust and pick-up spills using a clean, non-colored, lint-free cloth.