

# ASSEMBLY INSTRUCTIONS

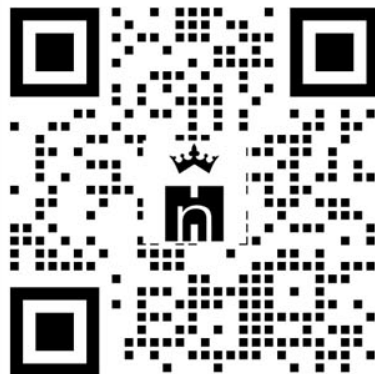

## ACCENT TABLE



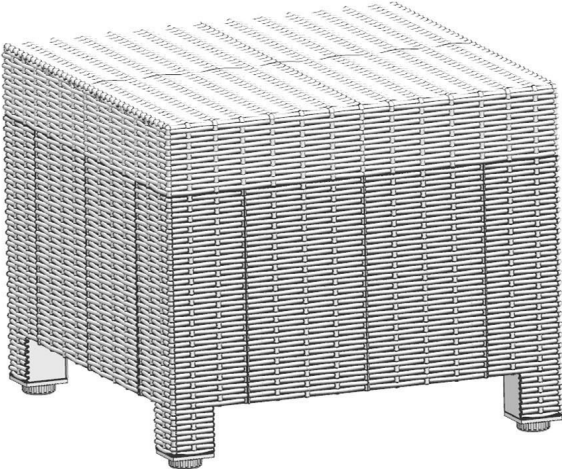

**SCAN FOR ASSEMBLY VIDEO AND ONLINE  
INSTRUCTION MANUAL**

# This Accent Table includes the following:

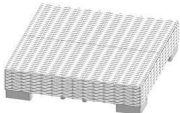

## ACCENT TABLE ASSEMBLE PARTS

PART	DESCRIPTION	IMAGE	QUANTITY
AT-TT	Accent Table Top		1
RC-SP	Short Side Panel		4
CTR-LG	Coffee Table Legs		4

\*Patent pending

# ASSEMBLY

1

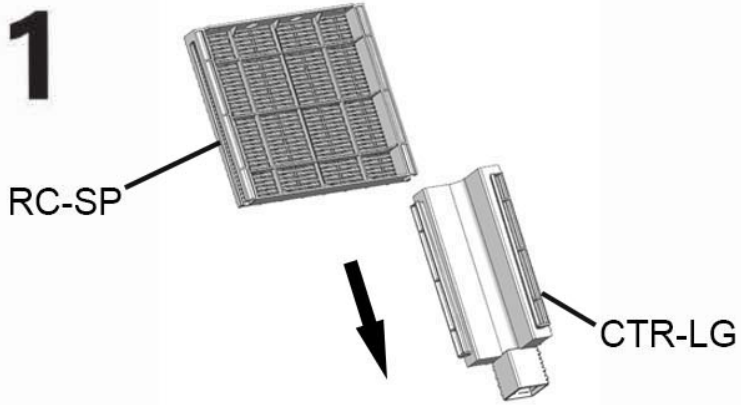

2

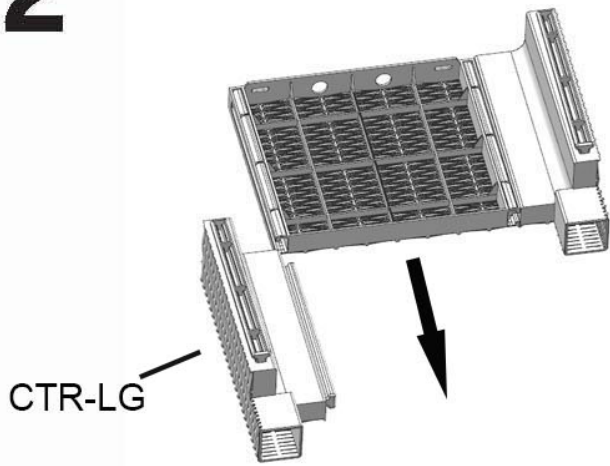

3

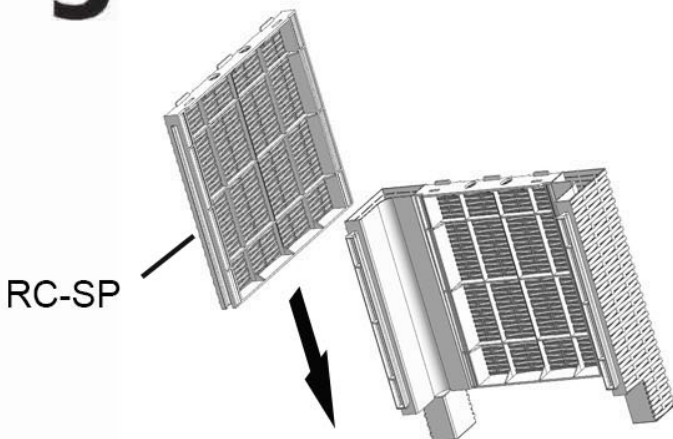

4

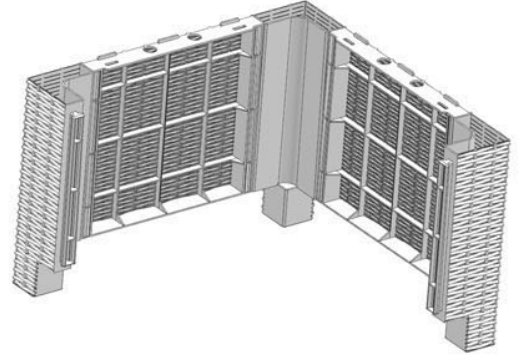
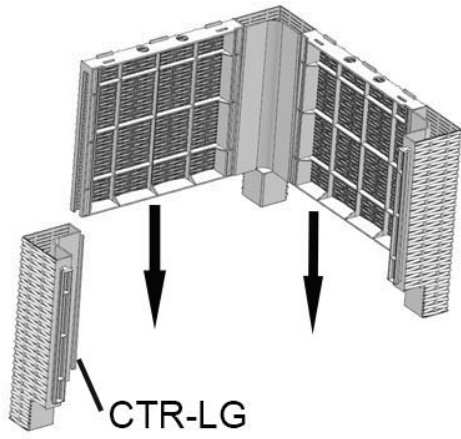

5

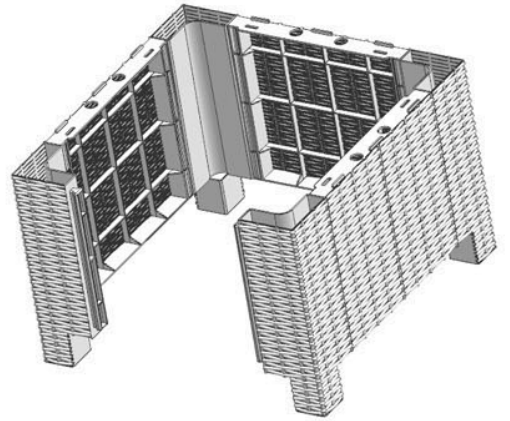
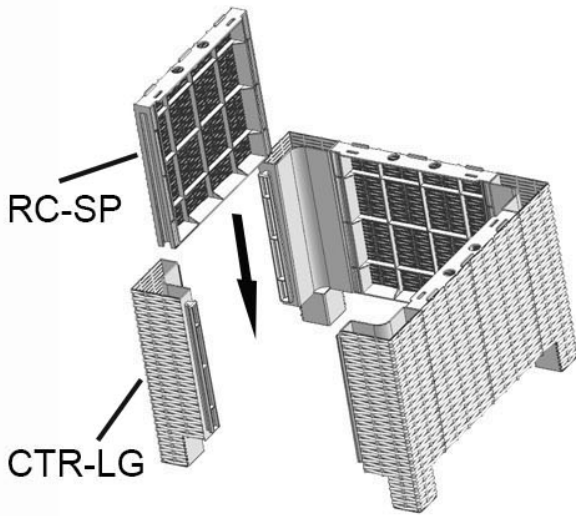

6

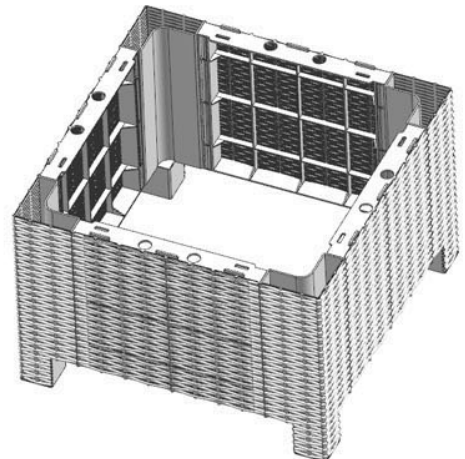
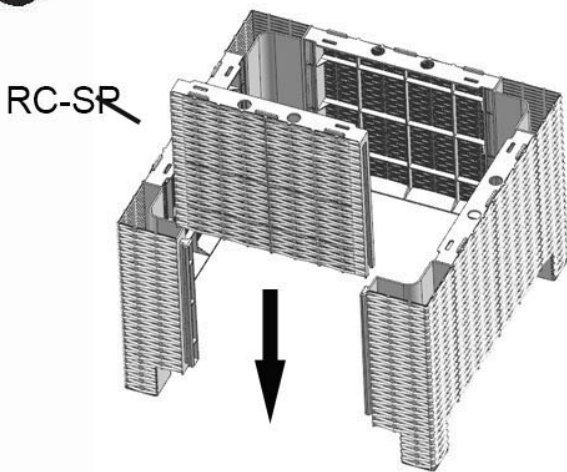

\*patent pending







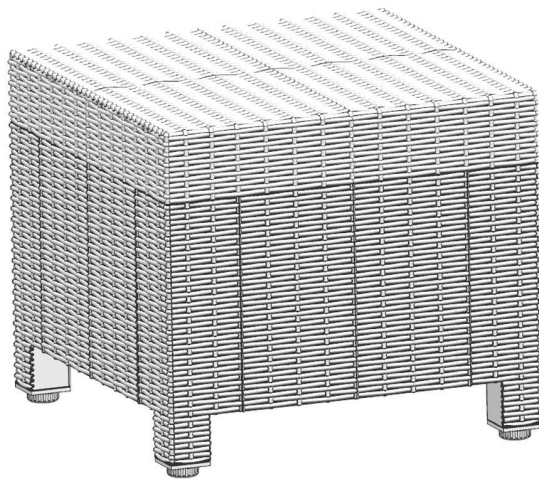
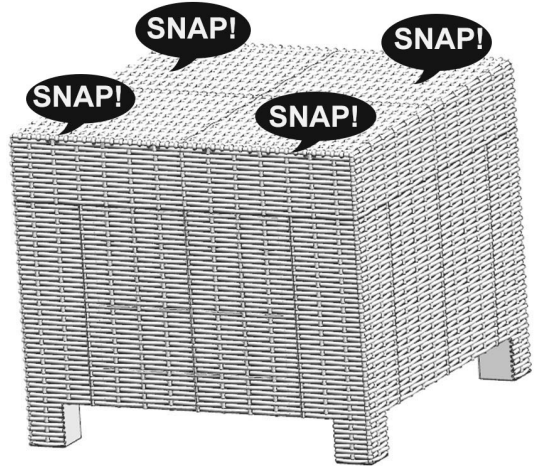
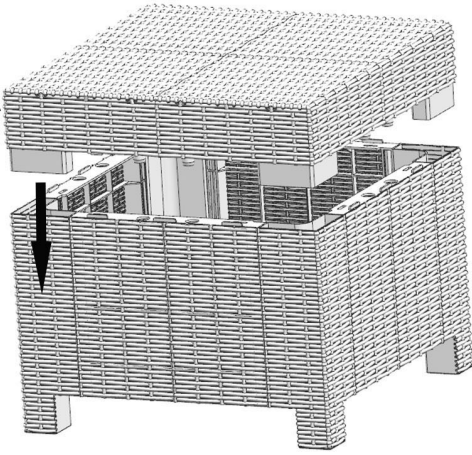





7

AT-TT



\*patent pending

## Care & Maintenance

- ⊘  ● Do not put hot items directly on furniture surface.
  - ⊘  ● Do not clean furniture with harsh cleansers or polish.
  - ✓  ● To obtain the longest lifespan of your outdoor products, minimizing exposure to direct sunlight is recommended.
  - ⊘  ● Children should not climb or jump on the furniture.
  - ⊘  ● Do not write on furniture without a padded barrier to protect the surface.
  - ✓  ● To obtain the longest lifespan of your outdoor products, avoid extended and lengthy exposure to rain, snow, and direct sunshine. Whenever possible cover the product and /or place under patio or awnings.
  - ⊘  ● Not for commercial use. For residential use only.
  - ⊘  ● Stains may be removed with mild soap solution and damp cloth.
  - ✓  ● Keep away from sources of ignition.
- 
- ✓  ● Dust and pick-up spills using a clean, non-colored, lint-free cloth.