

# Assembly Instructions

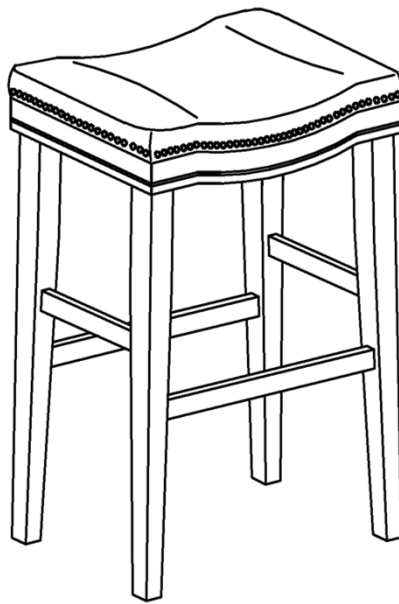

**Caution : You must read this before you proceed**

**Please look in the velcro pouch for hardware packs and legs.**

## **Bar Stool**



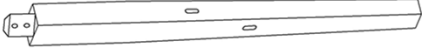



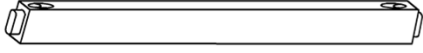
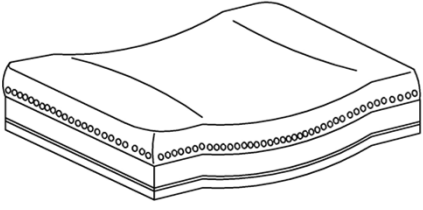

### Parts List

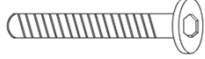
Label	Picture	Description	QTY
A		Leg	2
B		Leg	2
C		Upper Stretcher	2

D		Lower Stretcher	2
E		Cushion Seat	1





## Hardware

Label	Picture	Description	QTY
①		Bolt ( M6 x 45mm )	8
②		Spring Washer	8
③		Washer	8
④		Wood Screw ( M4 x 38mm )	8
⑤		Allen Key	1
⑥		Screwdriver (Not provided)	1

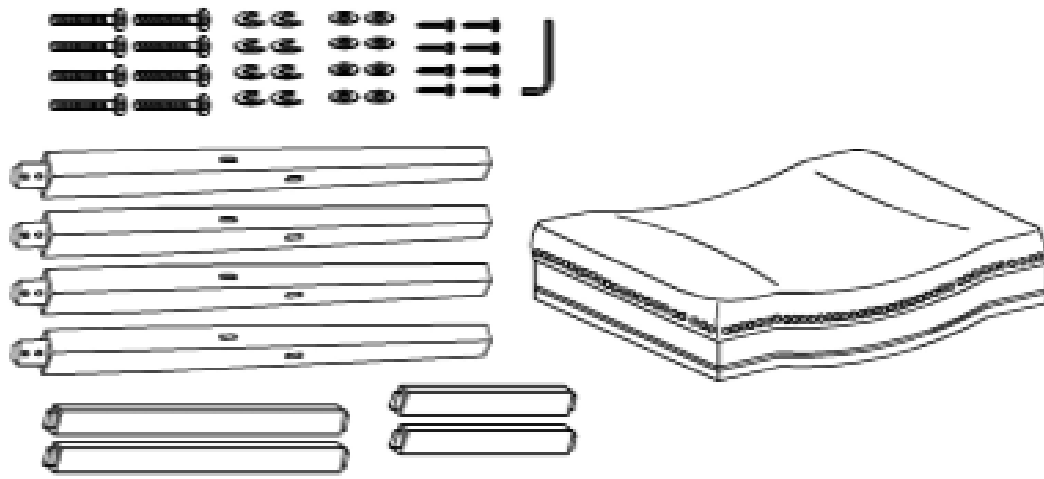
## Assembly Preparation

Before Beginning Assembly:  
Unpack and place all parts for clear visibility



-  • Read instructions, cover to cover-
-  • Have 2 adults on hand for assembly-
-  • Do not assemble on flooring or carpet-
-  • Assemble on a clean non-marring surface (packing foam)-
-  • Save all packaging until finished-

## Assembly Steps

### OVERVIEW

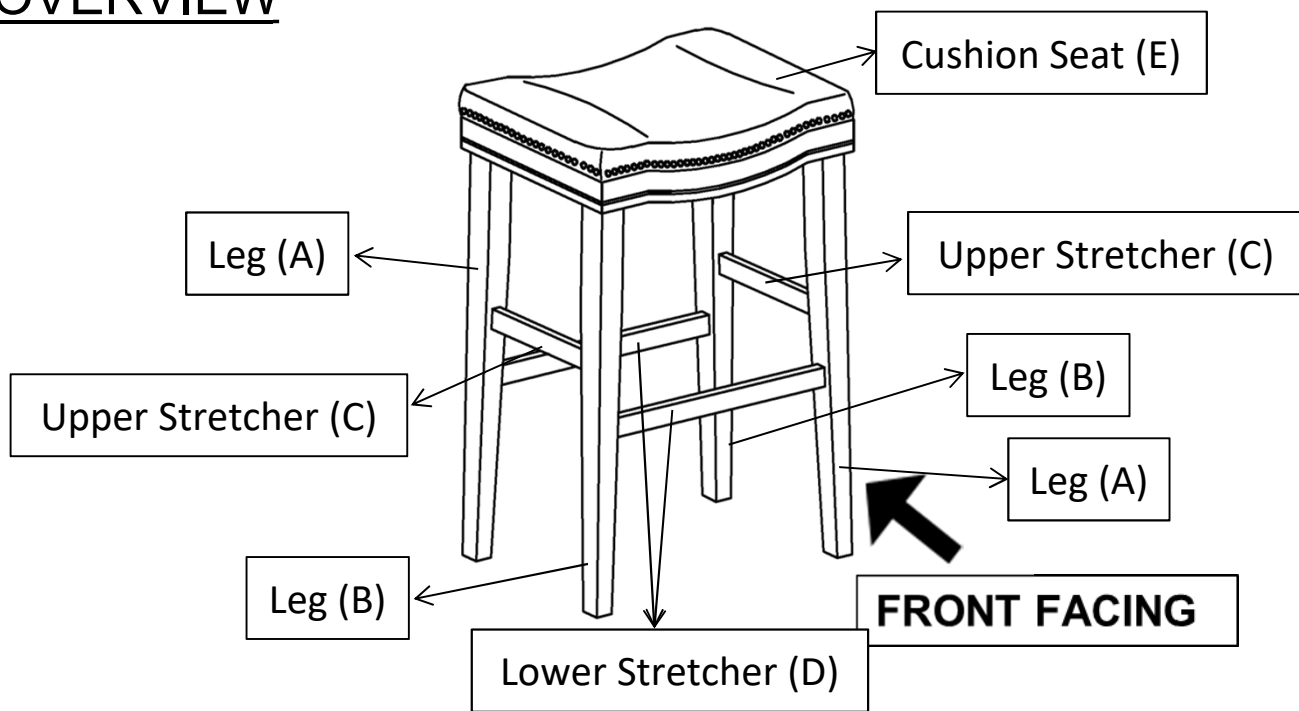

This Bar Stool has multiple parts and may require up to 30 minutes to assemble. To give you an overview of the Bar Stool parts, the above picture is to help you put the various parts into perspective. Please read through the instructions below to familiarise yourself with the parts and steps before assembly.

## Step 1

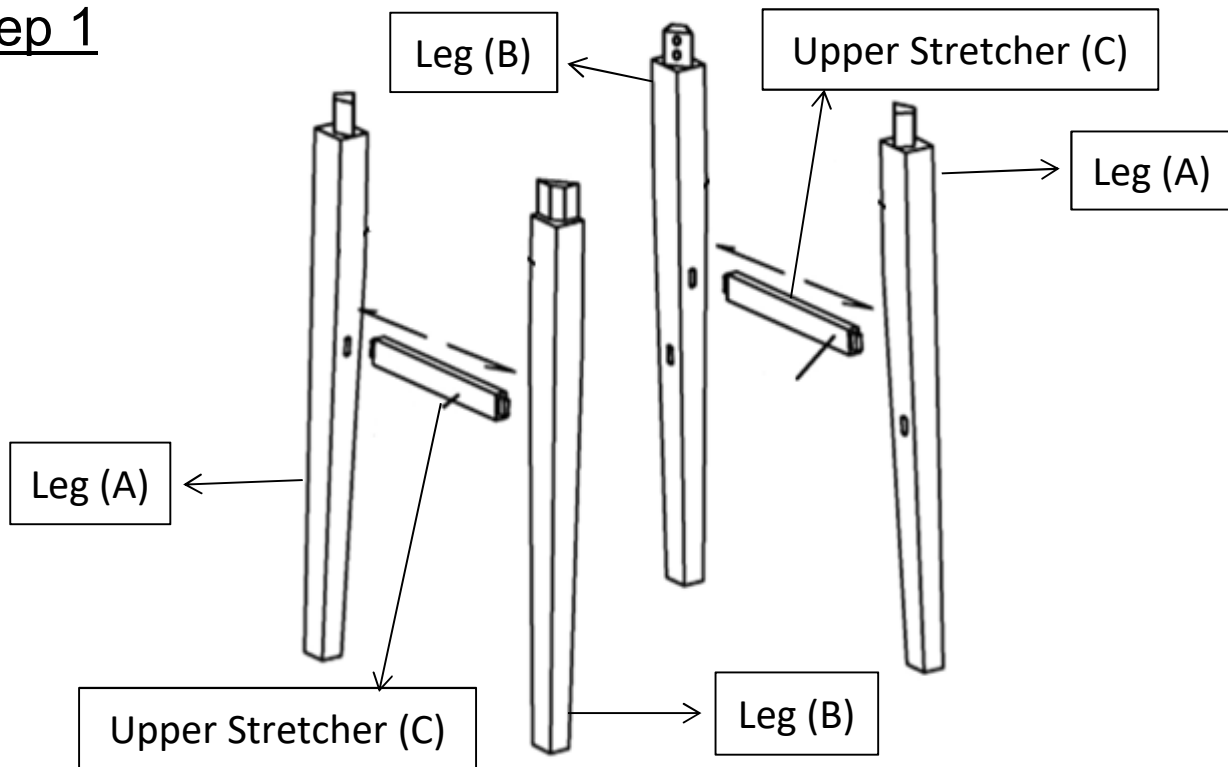

Place all the parts onto a clean, non-marring surface.

Insert a Upper Stretcher (C) between two Legs (A) & (B) as pictured.

Repeat the same process with another Upper Stretcher (C) and the other pair of Legs (A) & (B).

**Ensure that the mounting positions on Stretchers (C) are facing downwards; and the mounting positions on the Legs (A) & (B) all face inwards.**

## Step 2

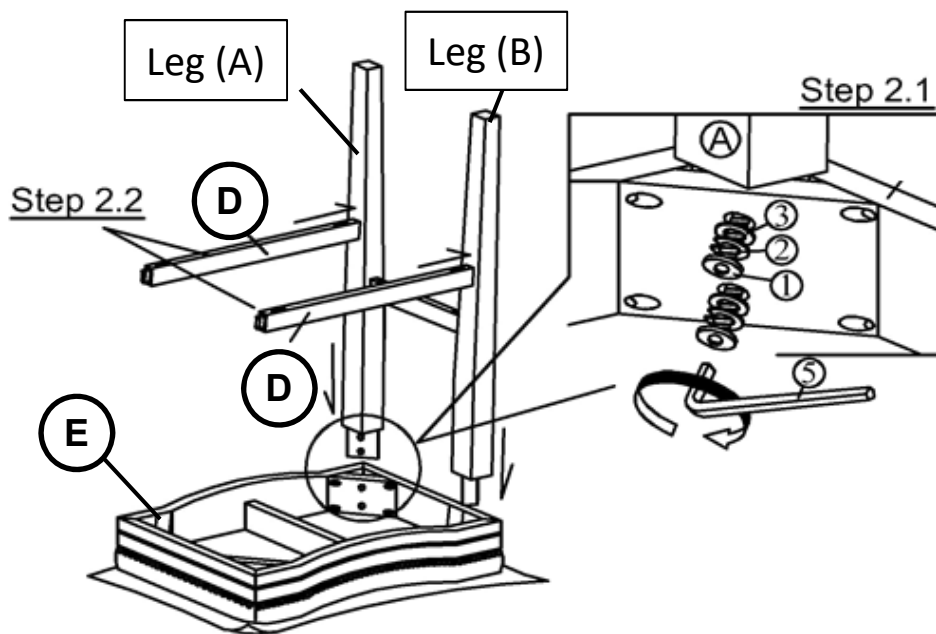

Place the Cushion Seat (E) facedown onto a clean, non-marring surface and carefully remove the Seat Cover.

**2.1)** Insert the first pair of Legs (A) & (B) into the Cushion Seat (E). Attach Legs (A) & (B) to the Cushion Seat (E) using Bolts (①), Spring Washers (②), and Washers (③) with Allen Key (⑤) as shown above.

**Do not fully tighten the Bolts.**

**2.2)** Insert the Lower Stretchers (D) into the Legs (A) & (B) as pictured.

## Step 3

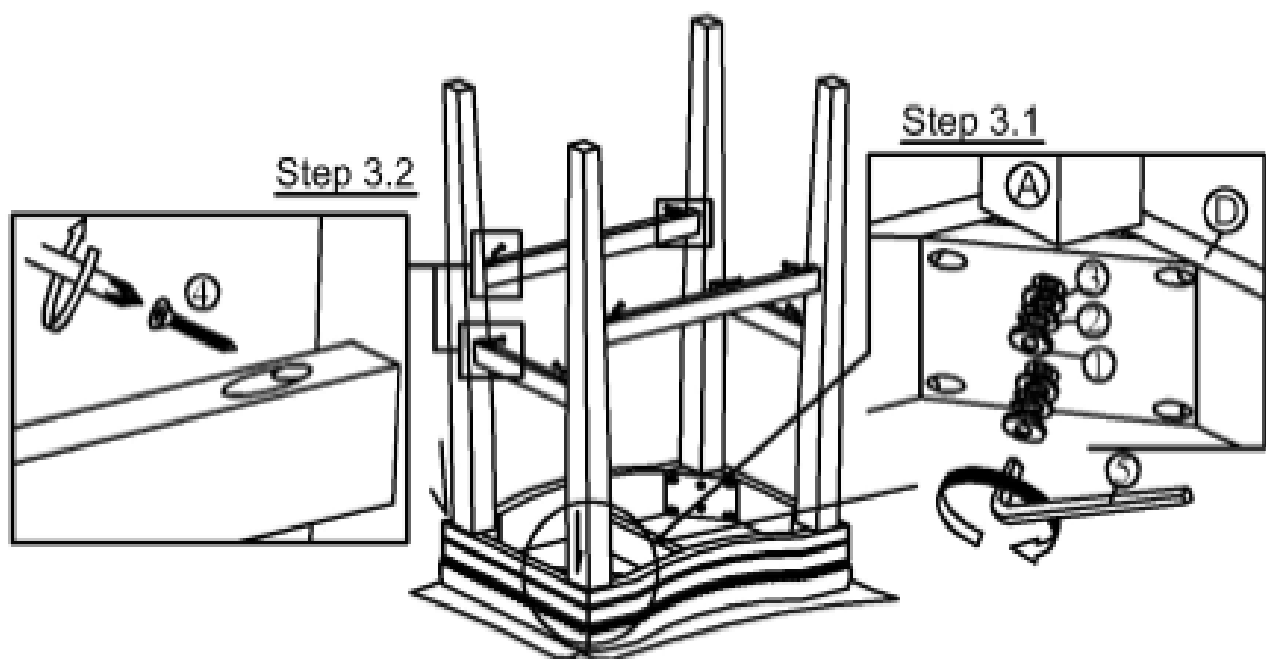

**3.1)** Insert the other pair of Legs (A) & (B) into the Stretchers (D) and Cushion Seat (E).

Then attach using Bolts (①), Spring Washers (②), and Washers (③) with Allen Key (⑤) as shown above.

**Do not fully tighten the Bolts.**

**3.2)** Attach Stretchers (C) to Legs (A) & (B) using the Wood Screws (④) with Screw Driver (⑥) as shown above.

**Do not fully tighten the Screws.**

#### Step 4

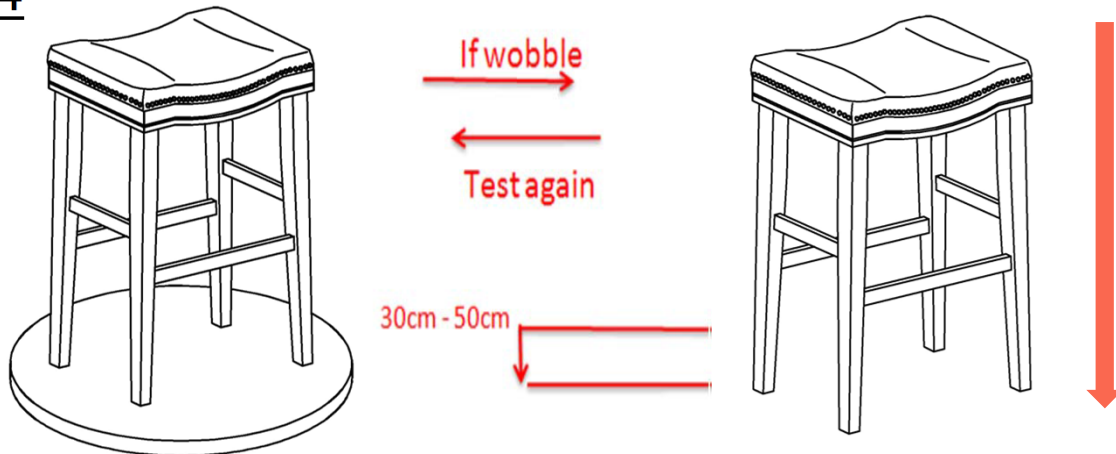

Place the Bar Stool on a **LEVEL SURFACE** to see if it wobbles.

If it wobbles, lift the Bar Stool some 30cm to 50cm high from the ground.

Keep your feet and toes well away from the drop zone.

Drop the Bar Stool freely and vertically with the four legs, hitting the ground, at the same time.

This Drop Test will help to ensure that all the Bolts, Screws, and gaps reach full alignment status.

Test again for evenness on a **LEVEL SURFACE**.

If no wobbles found, proceed to tighten all Bolts and Screws.

**When tightening these Bolts and Screws, tighten sequentially.**

**DO NOT tighten any Bolt or Screw, fully and then move on towards the next one.**

**This could cause the frame to warp.**

**If there is still wobbles, loosen the Bolts and Screws and execute this same drop test.**

**If the Bar Stool is not Stable it could lead to damage to the product.**



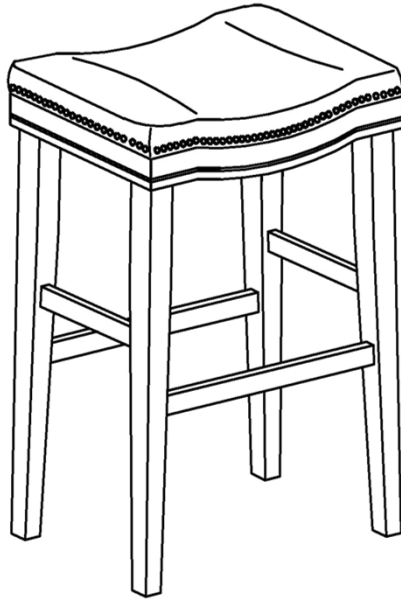















## Step 5



Your Bar Stool is now ready for use.

**This Bar Stool can only be used on a flat, level surface.**

## Care & Maintenance

-   • Do not put hot items directly on furniture surface.
-   • Do not clean furniture with harsh cleansers or polishes.
-   • Do not place furniture under direct sunlight.
-   • Do not place furniture near heating or cooling vents.
-   • Do not write on furniture without a padded barrier to protect the surface.
-   • Do not place furniture outside. For indoor use only.
-   • Not for commercial use. For residential use only.
-   • Stains may be removed with mild soap solution and damp cloth.
-   • Children should not climb or jump on the furniture.

- 
-   • Dust and pick-up spills using a clean, non-colored, lint-free cloth.

### What is Proposition 65?

Proposition 65 is a California law that requires warning labels on products that may contain one of more than 800-plus chemicals or ingredients that the California Office of Environmental Health Hazard Assessment (OEHHA) has deemed to cause cancer or other reproductive toxicity. Chemicals and elements on this list include wood dust, brass, and other everyday substances, which can be found in very common household items, such as: lamps, tableware, jewelry, crystal glasses, electric cords, beauty products, automobiles, and furniture.

### Why Did I Find a Proposition 65 Warning on My Home Goods Product?

We include Proposition 65 warnings on all of our products because there is always a chance that one of the 800-plus common chemicals and ingredients listed under this law could potentially be on our furniture or packing materials. We risk large fines under this law, if we don't include this warning.

### Should I worry?

We realize you may be worried finding this warning on our products, but we want to reassure you that the hazardous exposure limits for any of these chemicals have never been found on furniture products that we've shipped to our customers. Additionally, this warning label is very common and can be found on almost every piece of furniture sold in the state of California.

### Just How Common Are Proposition 65 Warnings?

Proposition 65 warnings have become so common in California that it is hard to take a trip to a local bank, grocery store, or restaurant without finding at least one warning. In fact, even the Disney Land Resort has a Proposition 65 warning:

