

# ASSEMBLY INSTRUCTIONS

## KING BED

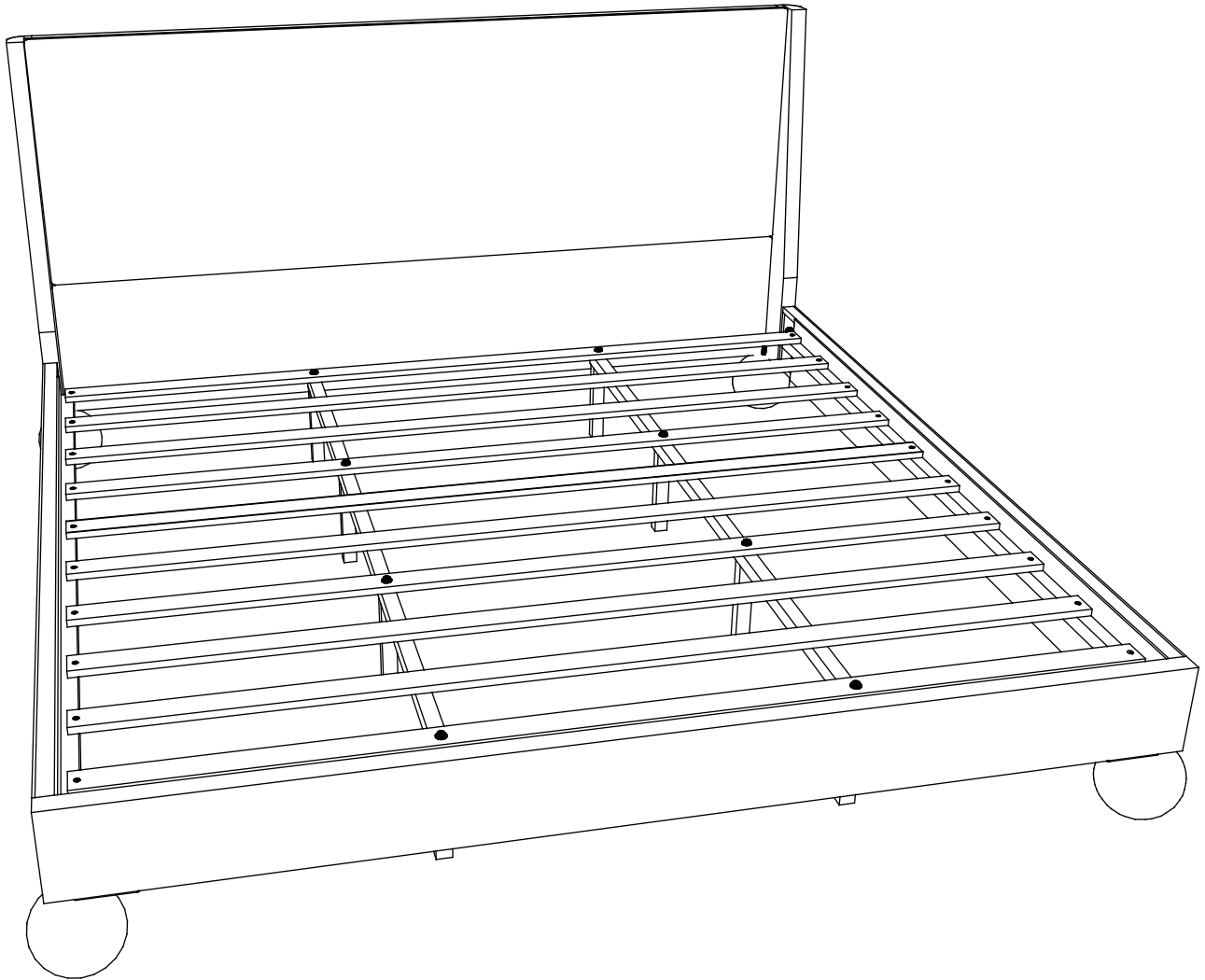



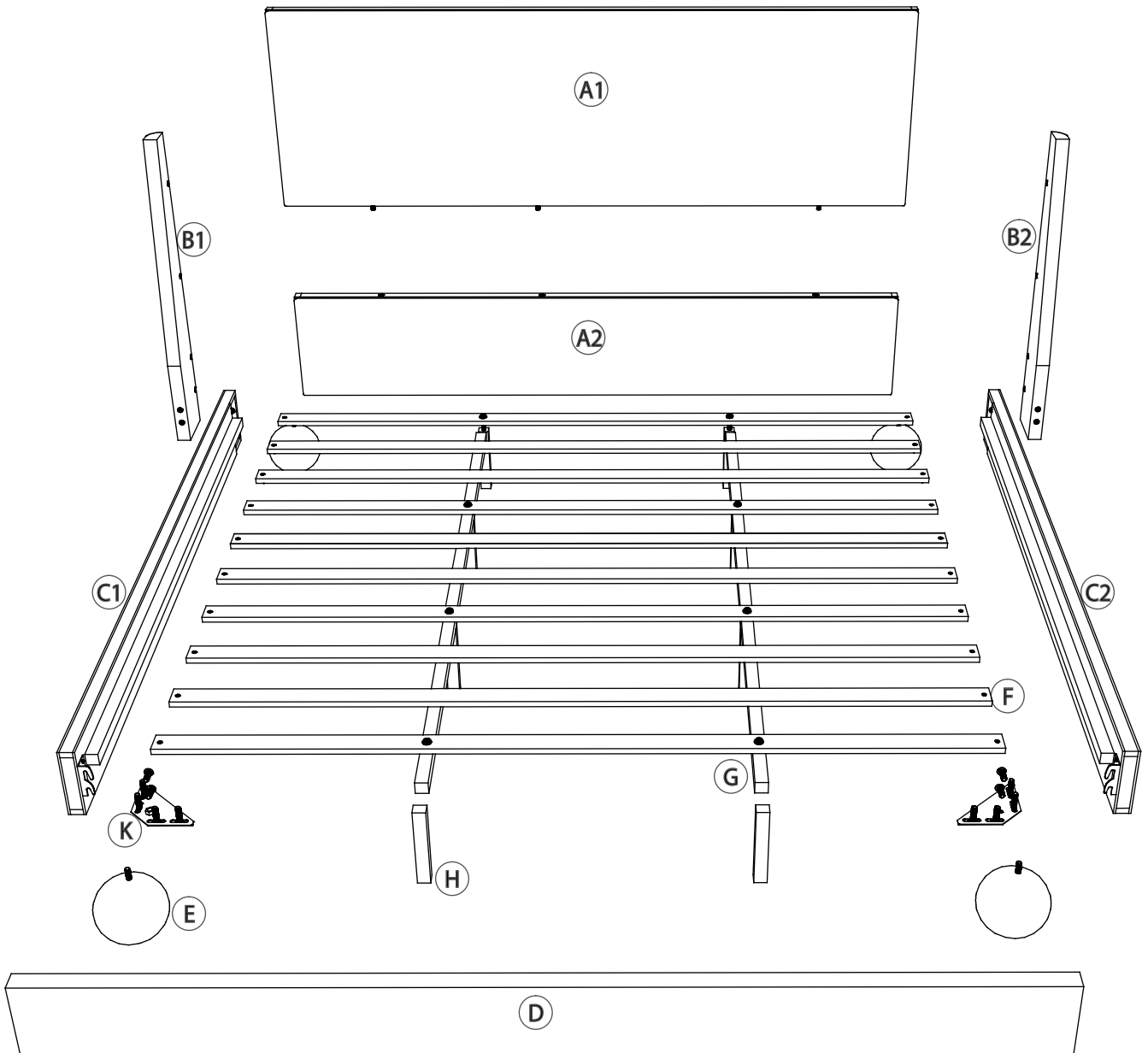

**WF531853**

# Detail View



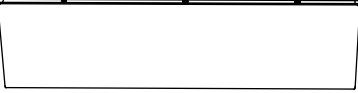

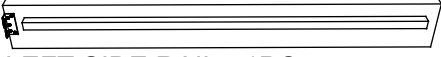
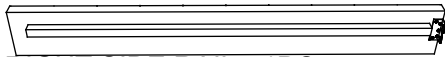
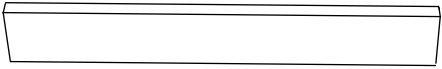
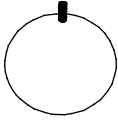

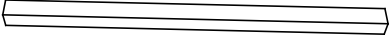
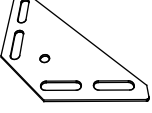
# Part List

**WF531853**

<b>A1</b>  TOP HEADBOARD - 1PC	<b>A2</b>  BOTTOM HEADBOARD - 1PC	<b>B1</b>  LEFT HEADBOARD ARM - 1PC
<b>B2</b>  RIGHT HEADBOARD ARM - 1PC	<b>C1</b>  LEFT SIDE RAIL - 1PC	<b>C2</b>  RIGHT SIDE RAIL - 1PC
<b>D</b>  FOOTBOARD - 1PC	<b>E</b>  HEAD&FOOT BOARD LEGS - 1PC	<b>F</b>  SLATS - 10PCS
<b>H</b>  CENTER SUPPORT LEGS - 8PCS	<b>G</b>  CENTER SUPPORT BAR - 2PCS	<b>K</b>  FOOTBOARD LEGS HOOK - 2PCS

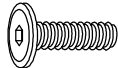
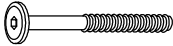
# Hardware List

in WF531853

<b>1</b>  Allen key (1pc)	<b>2</b>  5/16"*35mm Hex-Head bolts (19pcs)	<b>3</b>  1/4"*60mm Hex-Head bolts (8pcs)
<b>4</b>  5/16"*20mm Hex-Head bolts (8pcs)	<b>5</b>  5/16" Flat Washer (27pcs)	<b>6</b>  1/4" Flat Washer (8pcs)
<b>7</b>  F4*35mm Screw (20pcs)		

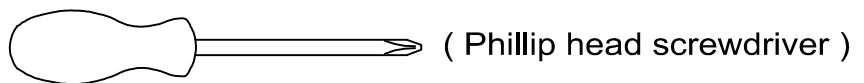

## ASSEMBLY TOOLS REQUIRED ( NOT INCLUDED )



**DO NOT USE POWER TOOLS TO ASSEMBLE THIS PRODUCT !**

## STEP 1:

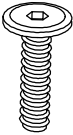

- Use Allen Key (1) to drive Bolt (2) fitted with Flat Washer (5) to install the Top Headboard (A1) to the Bottom HeadBoard (A2).

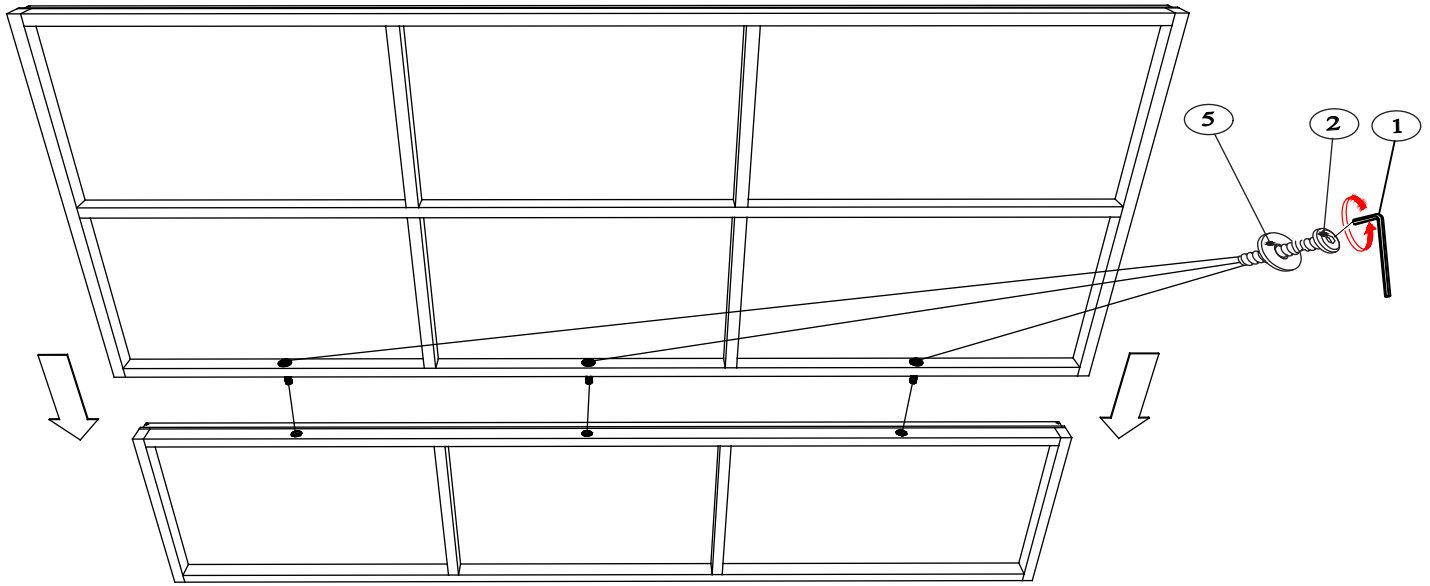
<b>2</b>		<b>5</b>	
<b>3PCS</b>		<b>3PCS</b>	

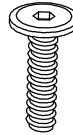

## STEP 2:

- Use Allen Key (1) to drive Bolt (2) fitted with Flat Washer (5) to install the Left & Right HeadBoard Arm (B1&B2) to the HeadBoard (A1&A2).

<b>2</b>		<b>5</b>	
<b>8PCS</b>		<b>8PCS</b>	

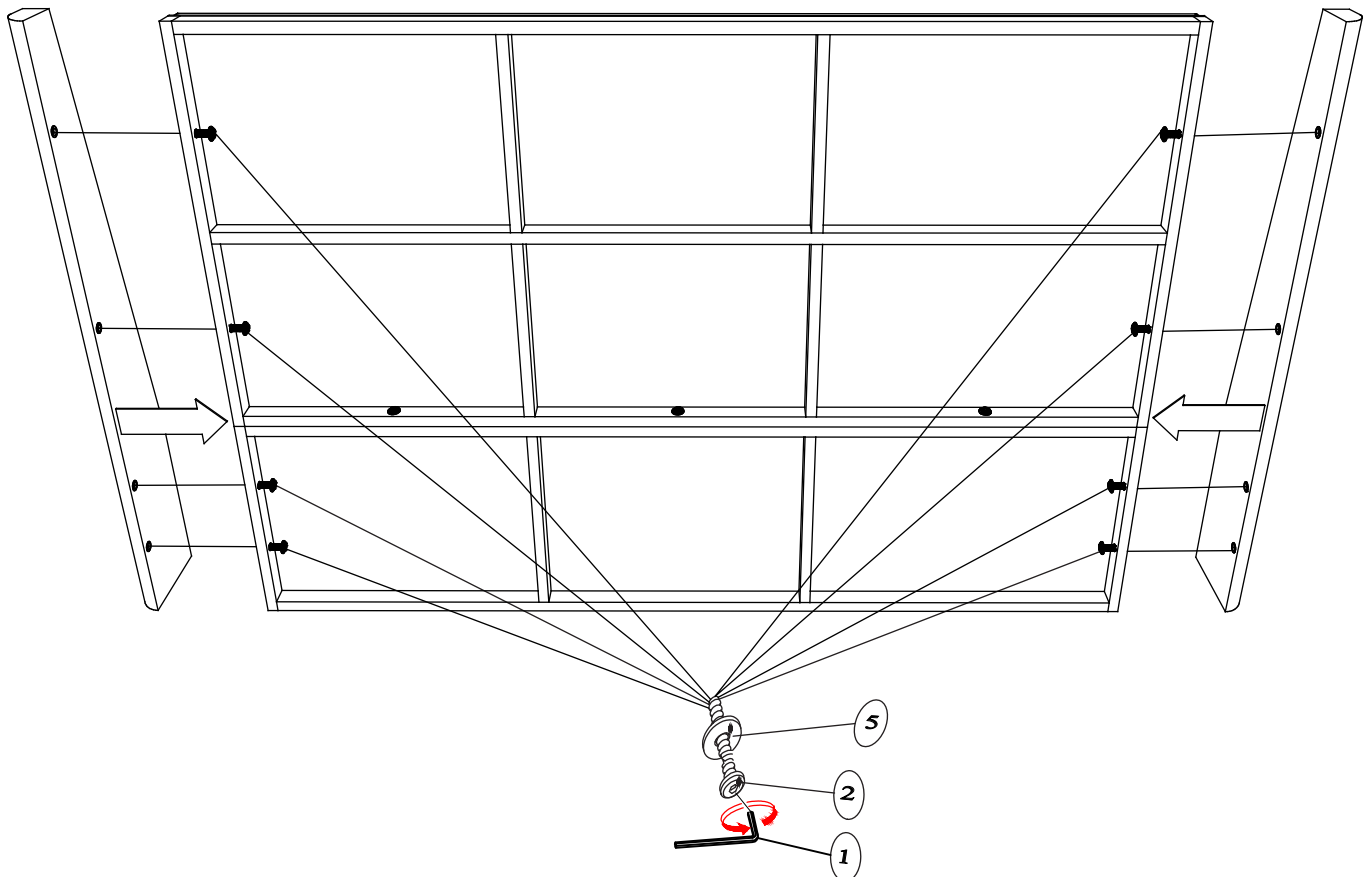

### STEP 3:

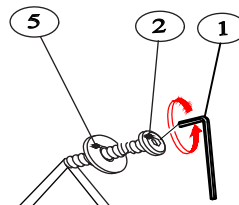

2		5	
4PCS		4PCS	

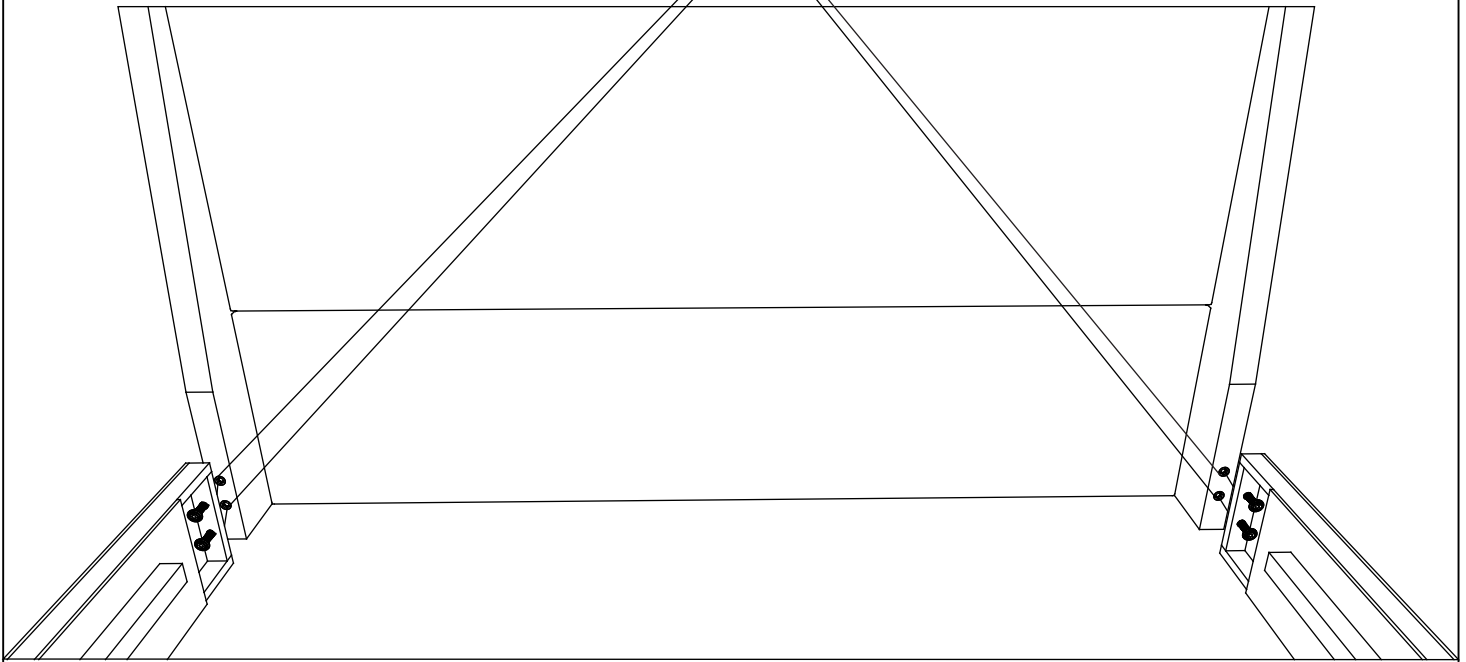

- Connect the Left and Right Side Rails (C1&C2) to Left and Right HeadBoard Arm by use Bolt (2) fitted with Flat Washer (5). Then tighten Bolt (2) fully.



### STEP 4:

- Place the hook of Left and Right Side Rails (C1&C2) to FootBoard (D). Then tighten Bolt (2) fully.

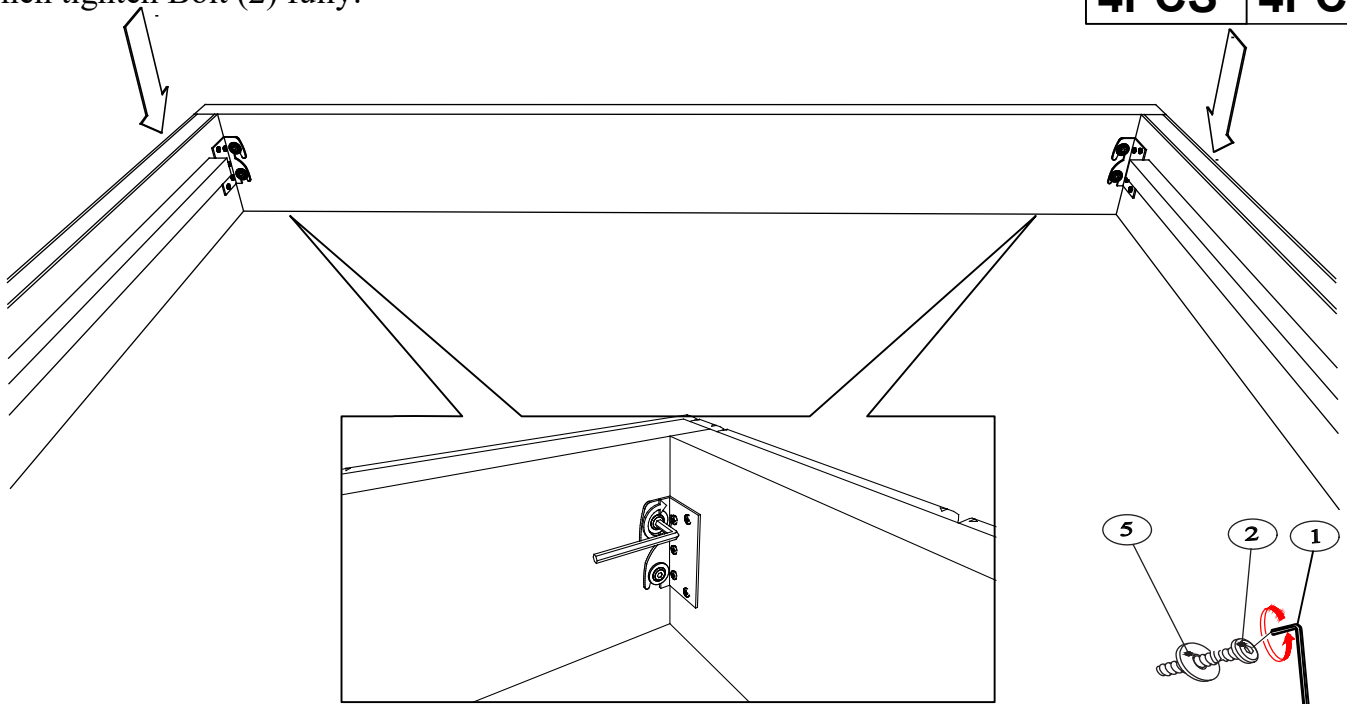
2		5	
4PCS		4PCS	

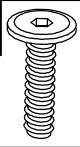

## STEP 5:

4		5	
8PCS		8PCS	

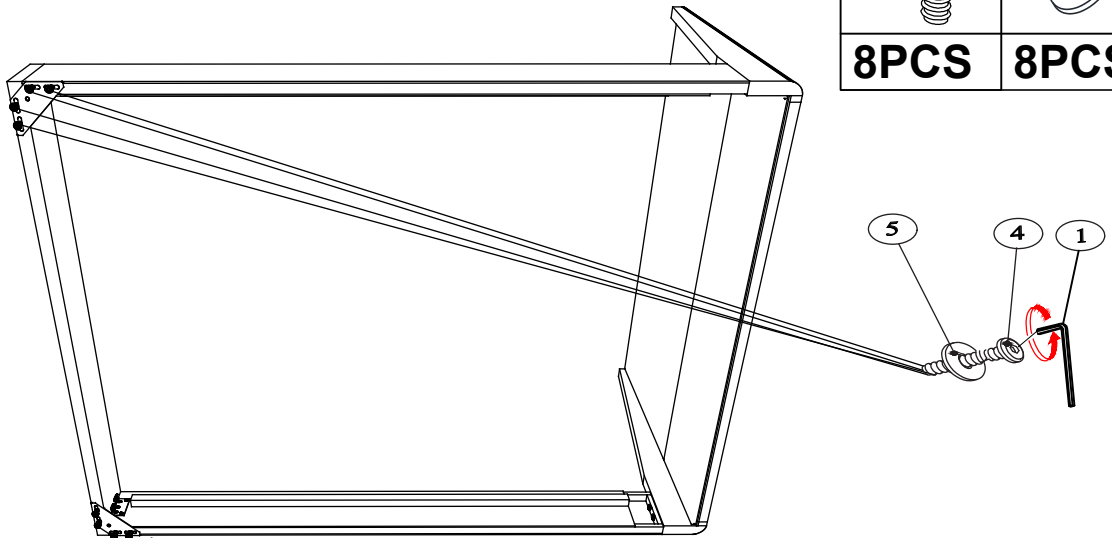

- Connect the FOOTBOARD LEGS HOOK (K) to Footboard and SideRails by use Bolt (4) fitted with Flat Washer (5). Then tighten Bolt (4) fully.

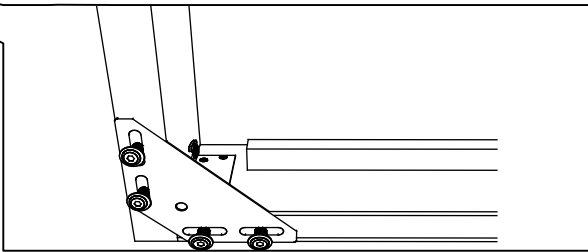



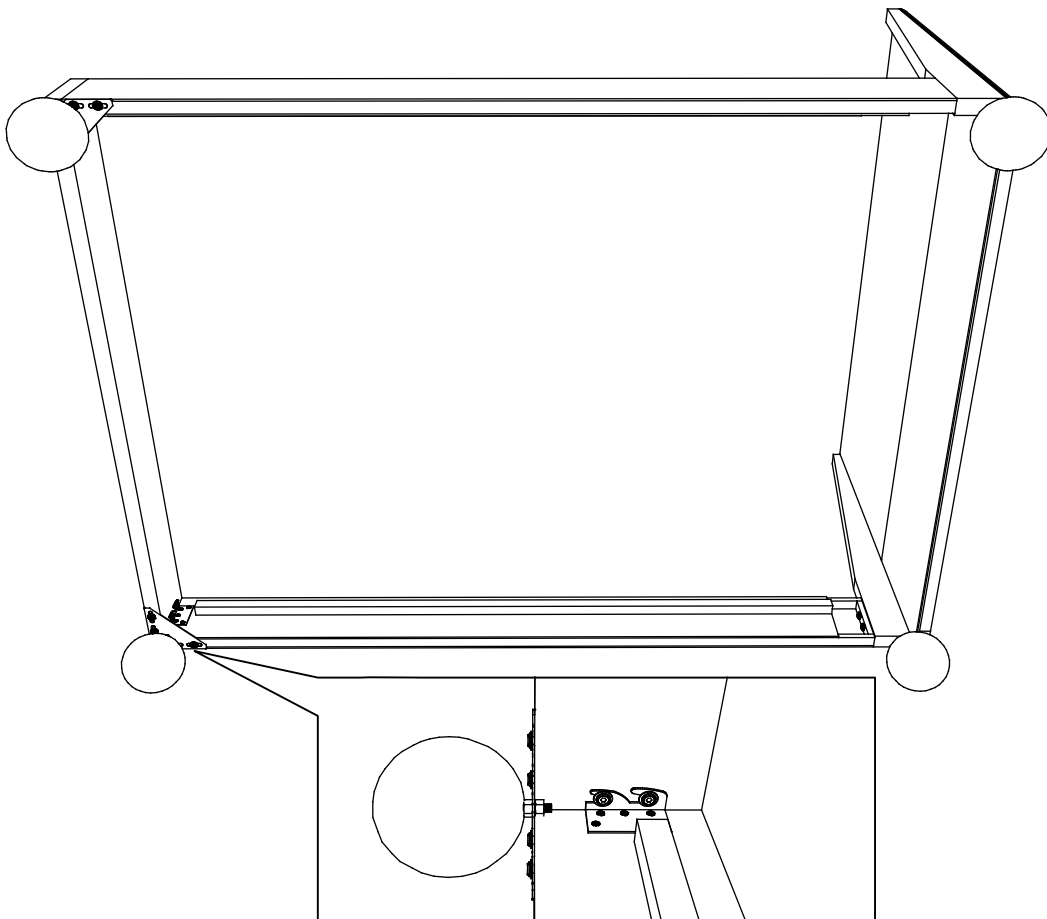

## STEP 6:

- Roll a nut in the legs first. Put the legs in the circle on the hook. Then roll the second nut fully.

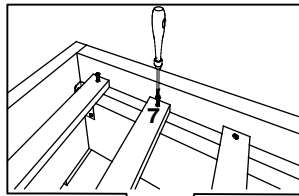

## STEP 7:



<b>3</b>		<b>6</b>		<b>7</b>	
<b>8PCS</b>		<b>8PCS</b>		<b>20PCS</b>	

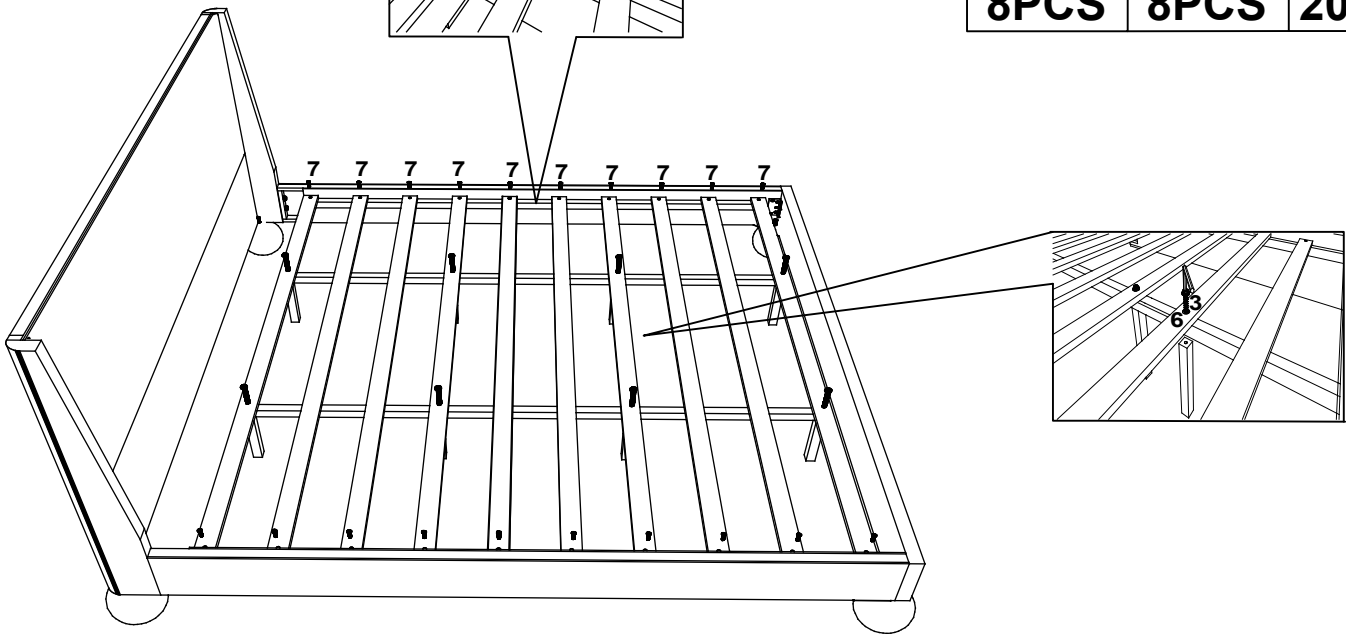

- Set Bolt (3) into Flat Washer (6), then pass assembled Bolts through Slat (S1,S4,S7,S10) and Center Support Bar (G) in turn, fit into Center Support Legs (H) then tighten with Allen Key (1).
- Use the ScrewDriver to install the Screw (7) into the hole on 2 heads of the Slat (F).

## STEP 8:

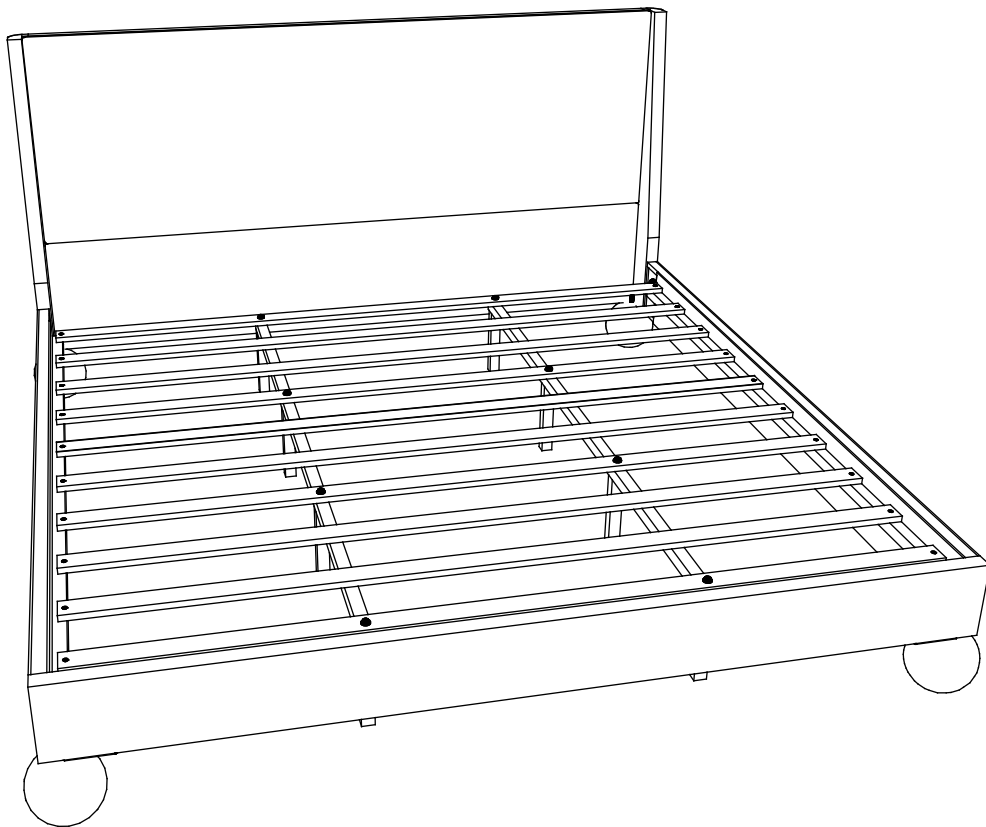

**THE BED IS COMPLETE !**