

# Assembly Instructions

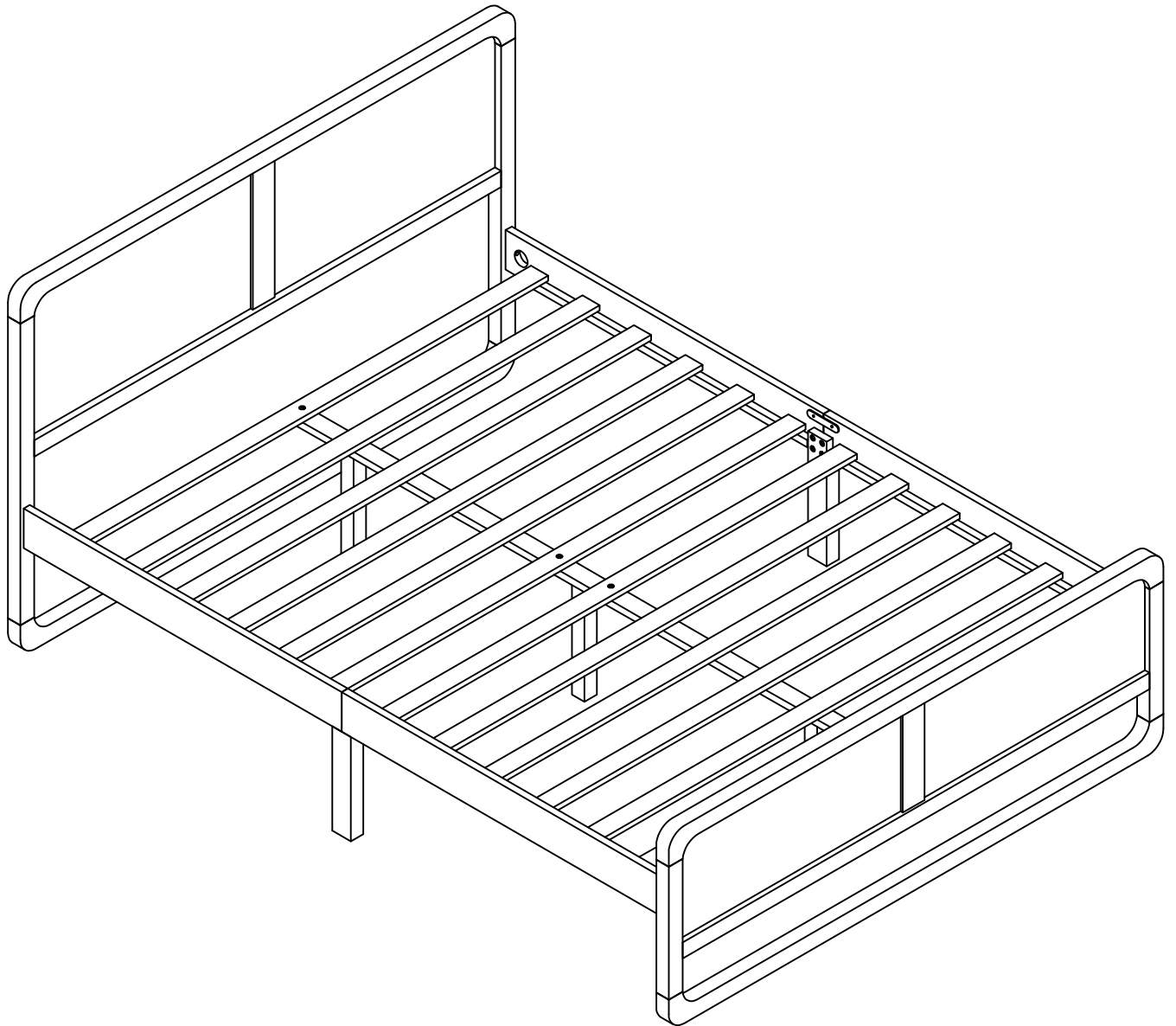

ITEM CODE: WF530456

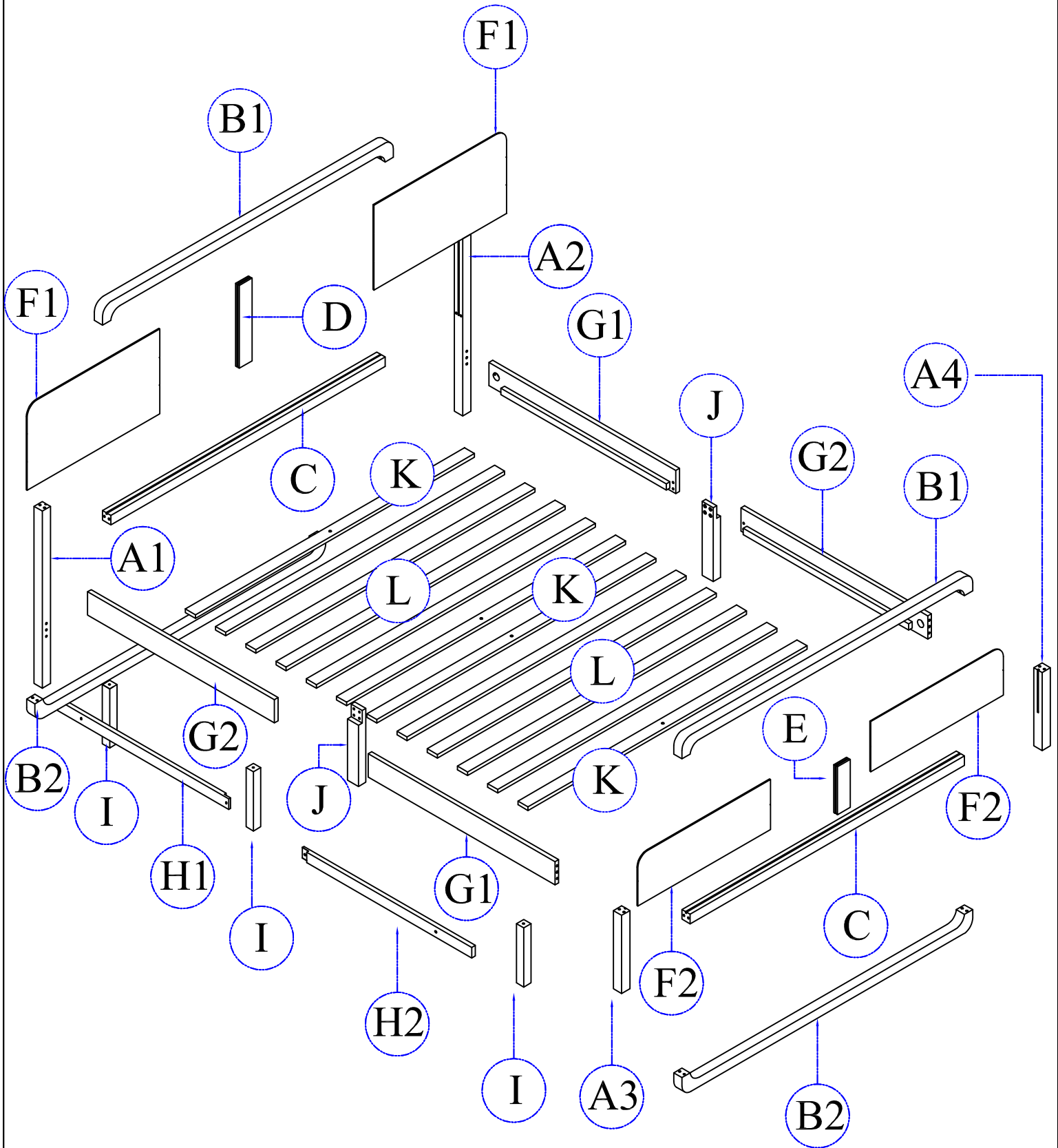





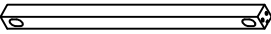
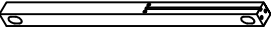
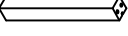
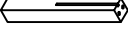
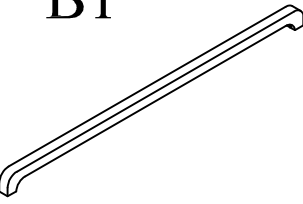
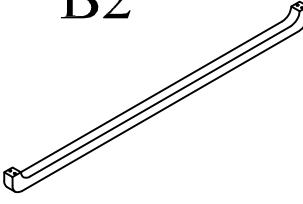
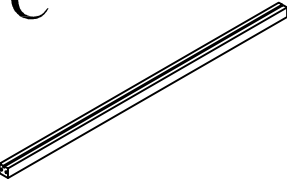

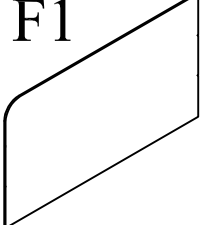
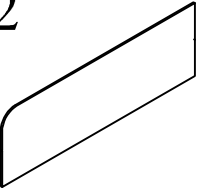
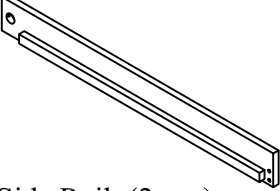
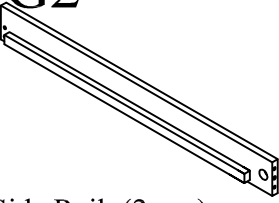
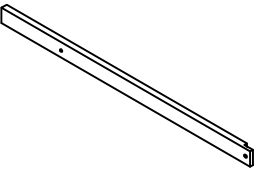
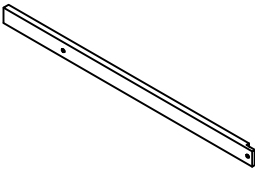
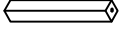
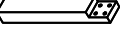
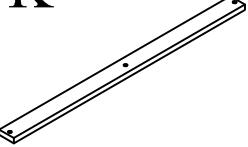
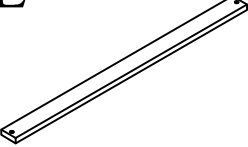

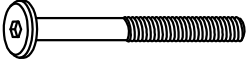
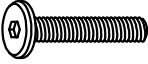
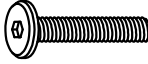

# DETAIL VIEW

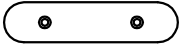
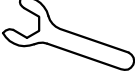

BOX : WF530456

<p><b>A1</b></p>  <p>Headboard post (L) (1 pc)</p>	<p><b>A2</b></p>  <p>Headboard post (R) (1 pc)</p>	<p><b>A3</b></p>  <p>Footboard post (L) (1 pc)</p>	<p><b>A4</b></p>  <p>Footboard post (R) (1 pc)</p>
<p><b>B1</b></p>  <p>Top slat (2 pcs)</p>	<p><b>B2</b></p>  <p>Bottom slat (2 pcs)</p>	<p><b>C</b></p>  <p>Middle slat (2 pcs)</p>	<p><b>D</b></p>  <p>Headboard Center bar (1 pc)</p>
<p><b>E</b></p>  <p>Footboard Center bar (1 pc)</p>	<p><b>F1</b></p>  <p>Headboard panel (2 pcs)</p>	<p><b>F2</b></p>  <p>Footboard panel (2 pcs)</p>	<p><b>G1</b></p>  <p>Side Rail (2 pcs)</p>
<p><b>G2</b></p>  <p>Side Rail (2 pcs)</p>	<p><b>H1</b></p>  <p>Center slat (1 pc)</p>	<p><b>H2</b></p>  <p>Center slat (1 pc)</p>	<p><b>I</b></p>  <p>Support post (3 pcs)</p>
<p><b>J</b></p>  <p>Support post side rail (2 pcs)</p>	<p><b>K</b></p>  <p>Slat with one center hole (4 pcs)</p>	<p><b>L</b></p>  <p>Slats no center hole (8 pcs)</p>	

# HARDWARE LIST : WF530456

<p>1</p>  <p>Hex - Head bolts Ø1/4" * 40 - 12pcs</p>	<p>2</p>  <p>Hex - Head bolts Ø1/4" * 30 - 8pcs</p>	<p>3</p>  <p>Hex - Head bolts Ø1/4" * 65 - 3pcs</p>	<p>4</p>  <p>Wood dowel Ø8 * 30 - 12pcs</p>
<p>5</p>  <p>Wood dowel Ø10 * 40 - 8pcs</p>	<p>6</p>  <p>Adjusting screw Ø1/4" * 30 - 3 pcs</p>	<p>7</p>  <p>Allen key M4*100 - 1pc</p>	<p>8</p>  <p>Wood crews M3.5 * 15 - 4pcs</p>
<p>9</p>  <p>Wood crews M4 * 30 - 28pcs</p>	<p>10</p>  <p>Connecting Metal=2 pcs</p>	<p>11</p>  <p>Wrench Metal =1 pc</p>	<p>12</p>  <p>Stud bolt Ø5/16" * 75 - 4pcs</p>
<p>13</p>  <p>connecting rod -4 pcs</p>	<p>14</p>  <p>Hexanon nut =4 pcs</p>		

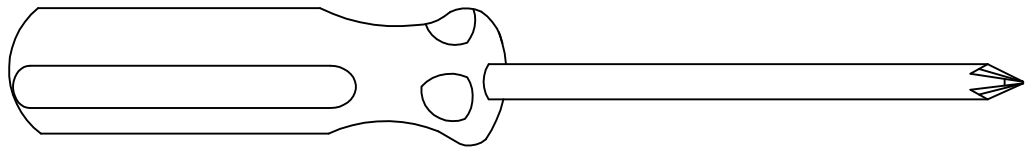

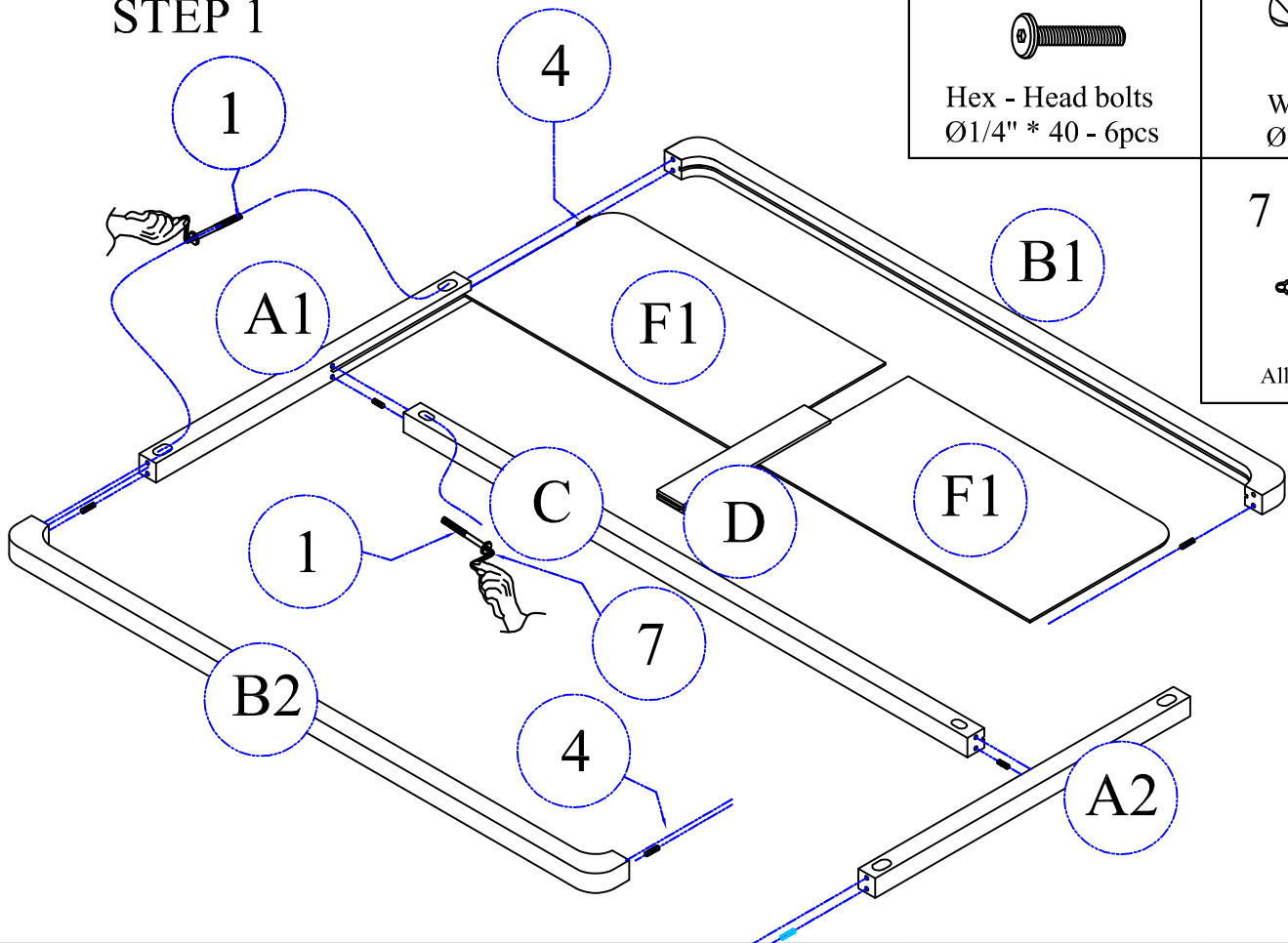

Assembly Tools Required (Not Included)

# STEP 1

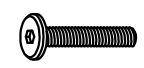

1  
  
 Hex - Head bolts  
 Ø1/4" \* 40 - 6pcs

4  
  
 Wood dowel  
 Ø8 \* 30 - 6pcs

7  
  
 Allen key K4 - 1pc

# STEP 2

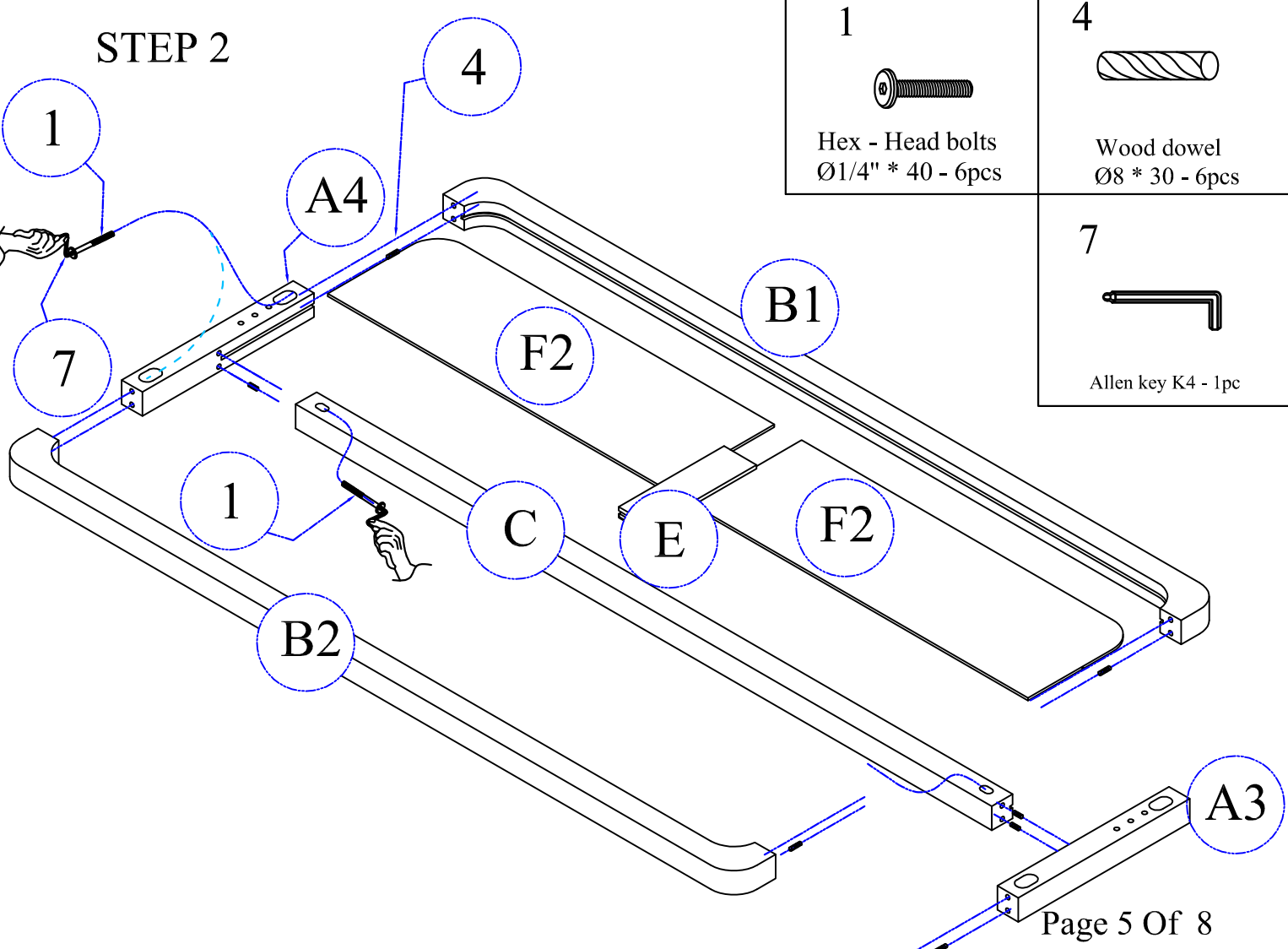

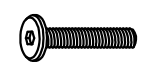

1  
  
 Hex - Head bolts  
 Ø1/4" \* 40 - 6pcs

4  
  
 Wood dowel  
 Ø8 \* 30 - 6pcs

7  
  
 Allen key K4 - 1pc

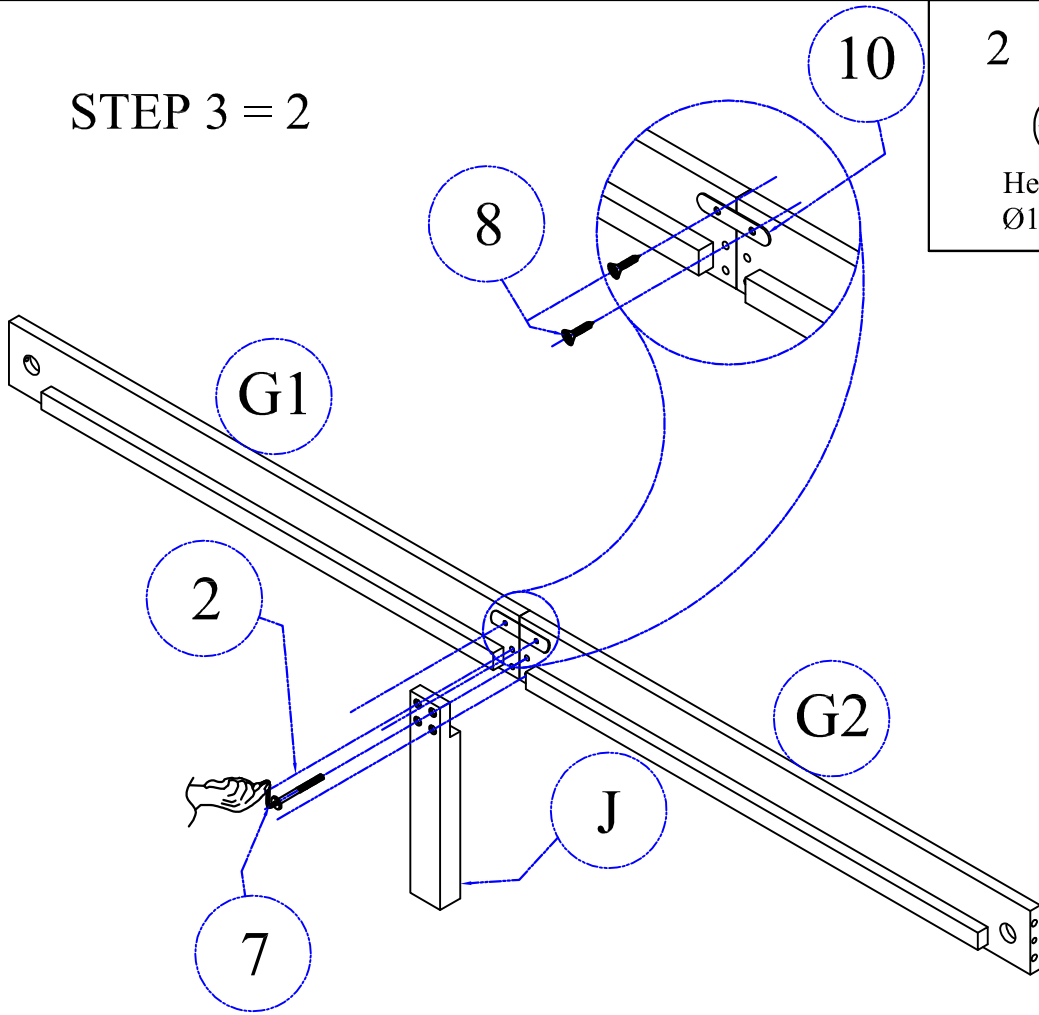
STEP 3 = 2



2  
  
 Hex - Head bolts  
 Ø1/4" \* 30 - 4pcs

7  
  
 Allen key K4 - 1pc

8  
  
 Wood crews  
 M3.5 \* 15 - 2pcs

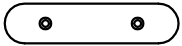
10  
  
 Connecting Metal = 1 pc

STEP 4

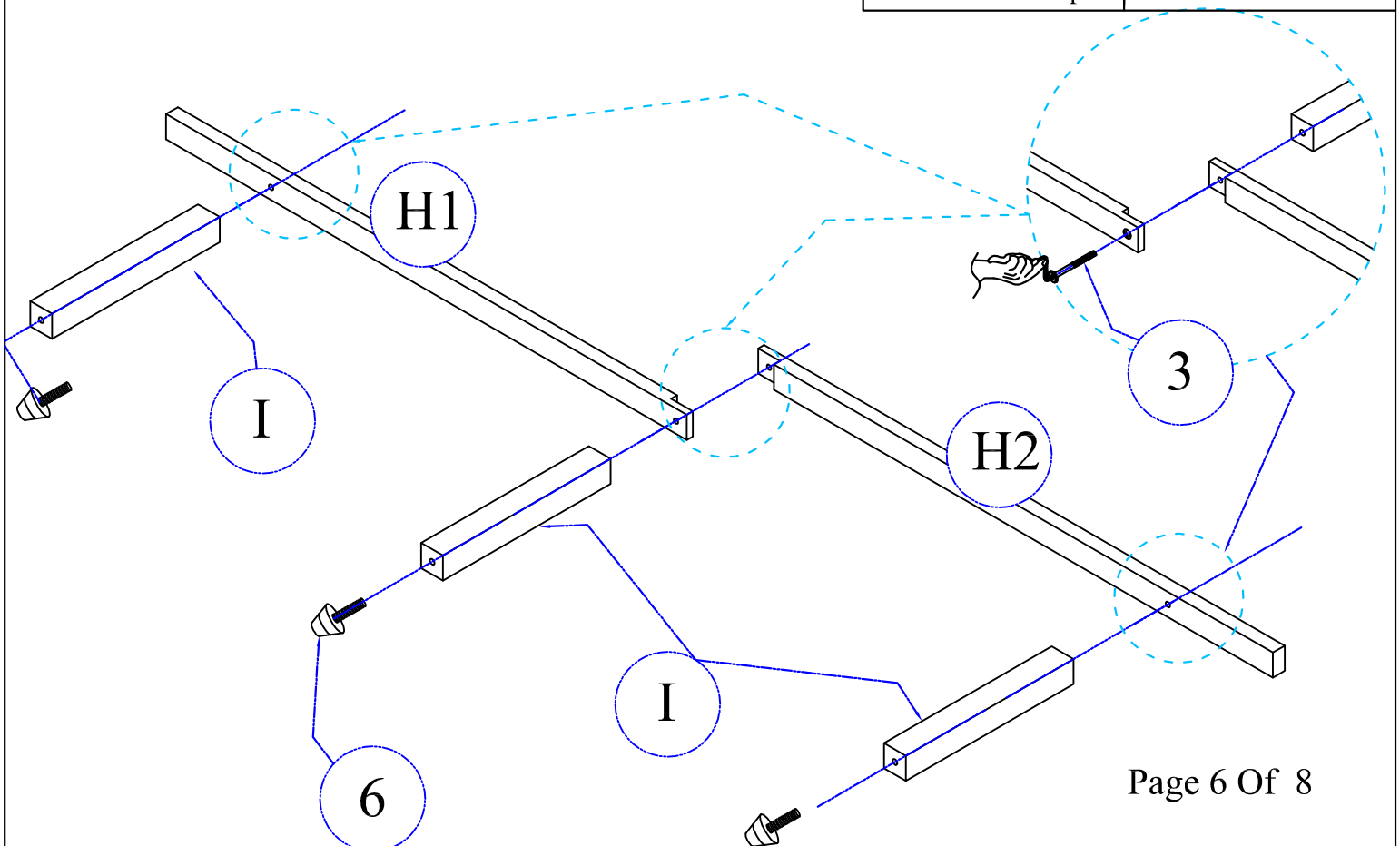

6  
  
 Adjusting screw  
 Ø1/4" \* 30 - 3 pcs

3  
  
 Hex - Head bolts  
 Ø1/4" \* 65 - 3pcs

# STEP 5

**5**



Wood dowel  
Ø10 \* 40 - 8pcs

**11**

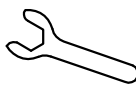

Wrench Metal=1 pc

**12**



Stud bolt  
Ø1/4" \* 75 - 4pcs

**13**



Connecting rod -4 pcs

**14**



Hexanon nut = 4 pcs

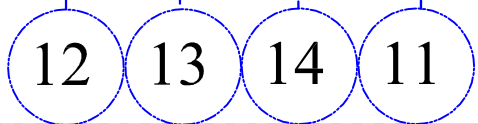
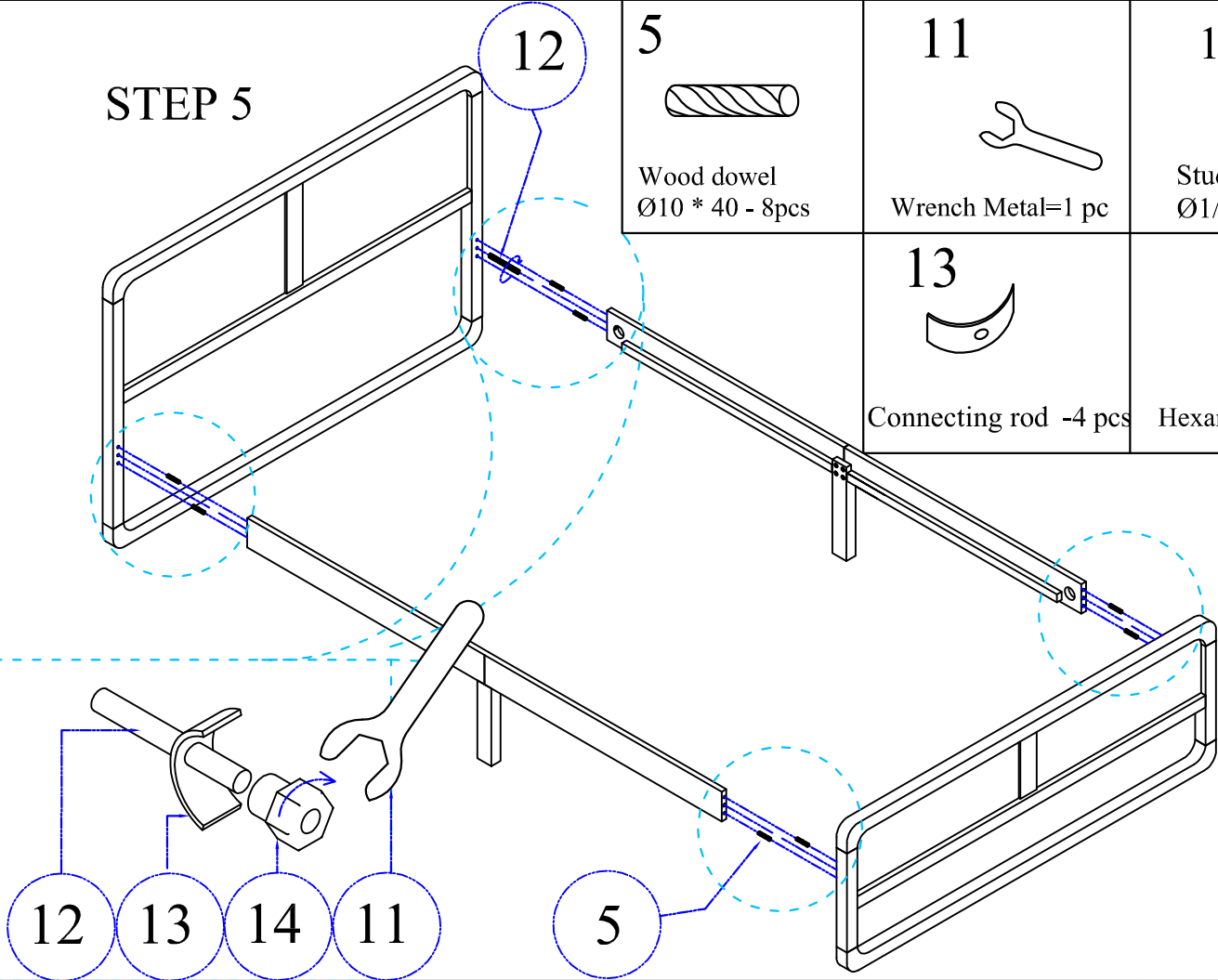

# STEP 6

**9**



Wood crews  
M4 \* 30 - 24pcs

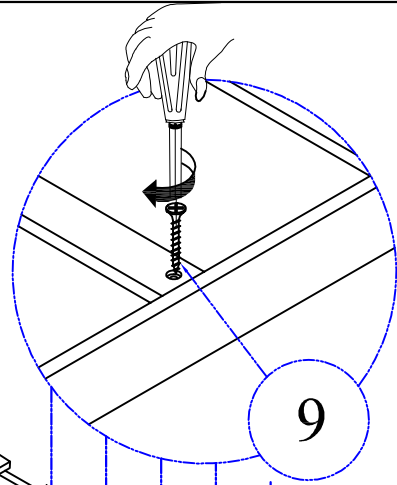
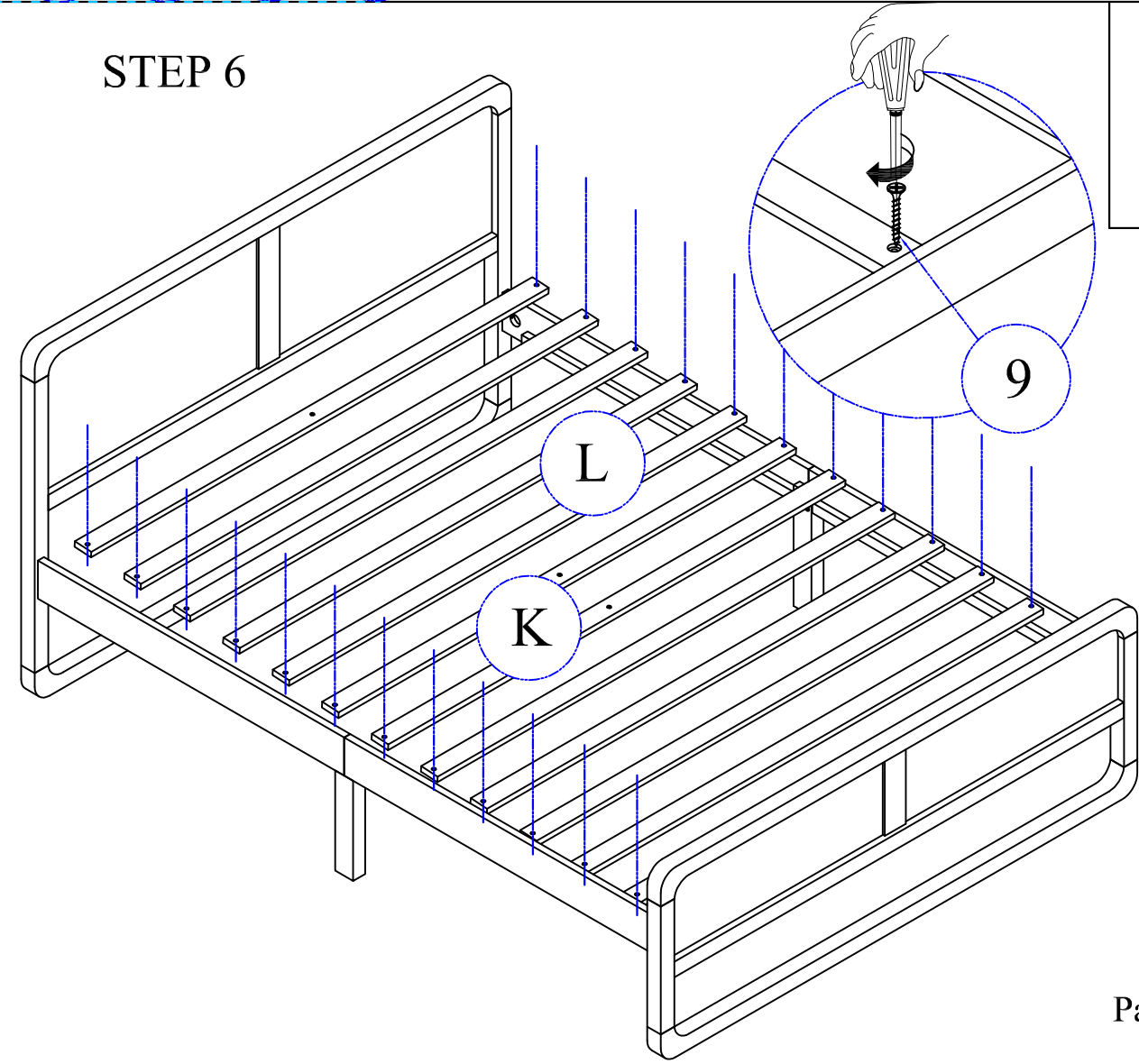

# STEP 7

9



Wood crews  
M4 \* 30 - 4 pcs

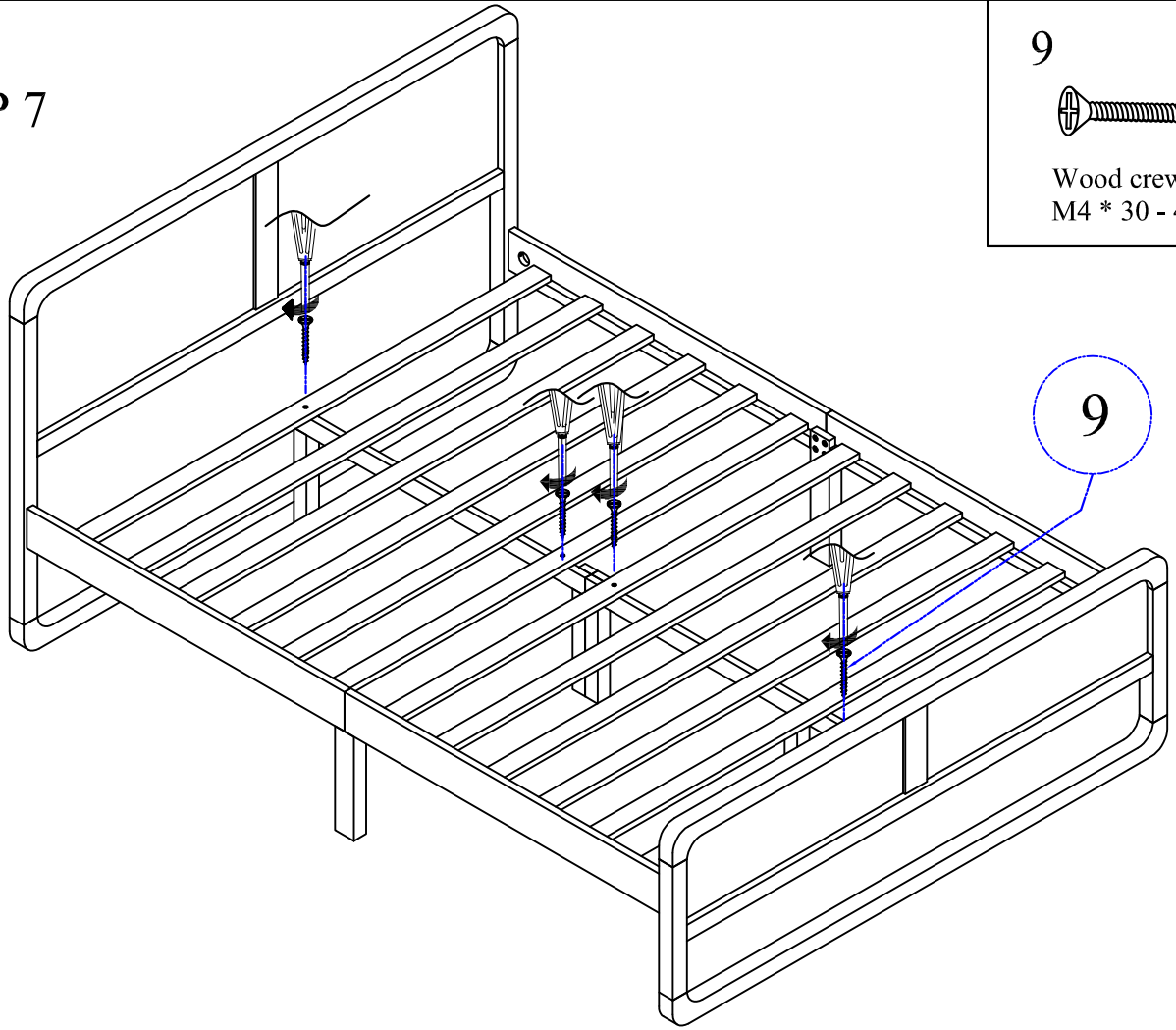

# STEP 8

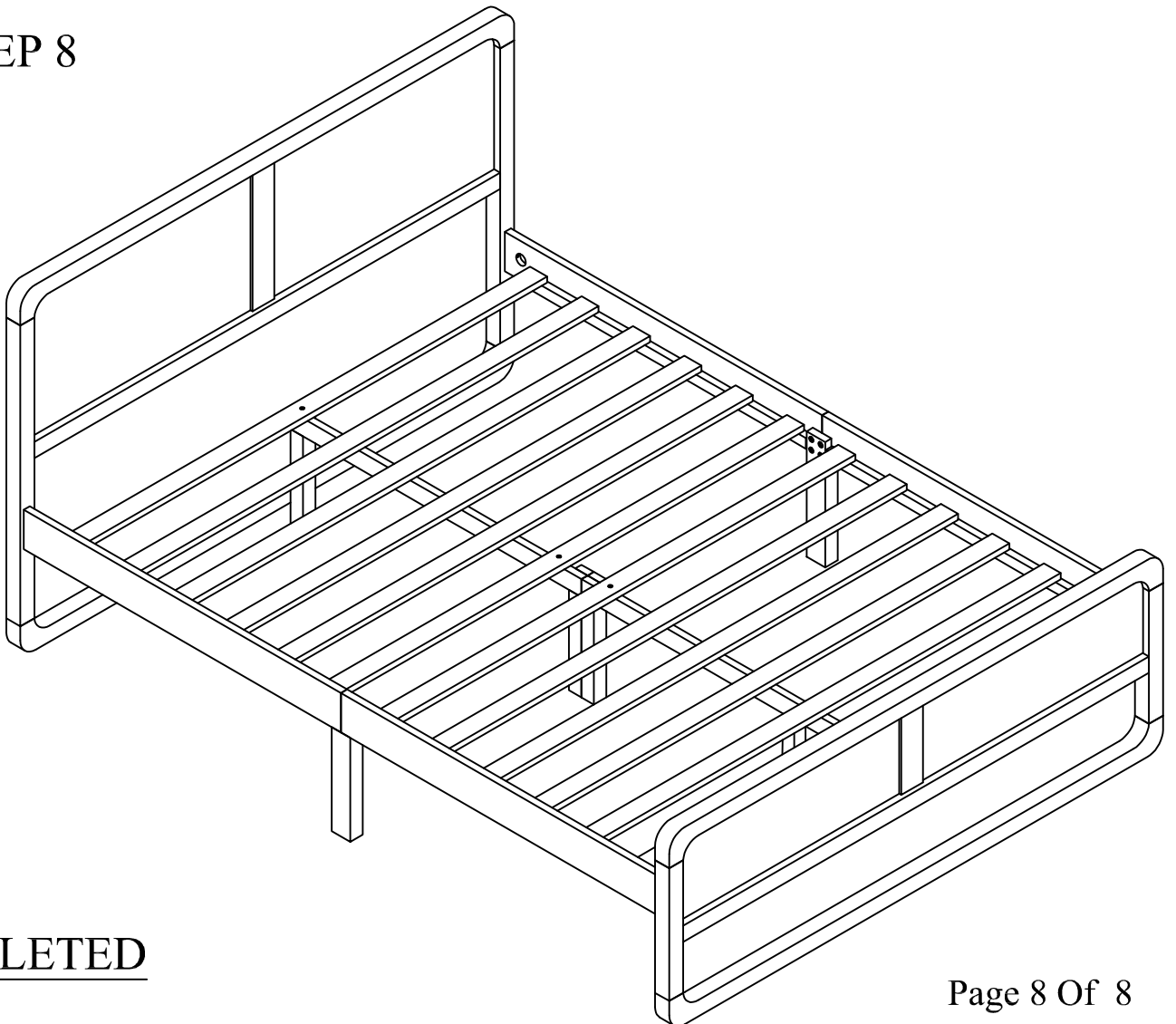

COMPLETED