

ASSEMBLY INSTRUCTIONS

KING BED

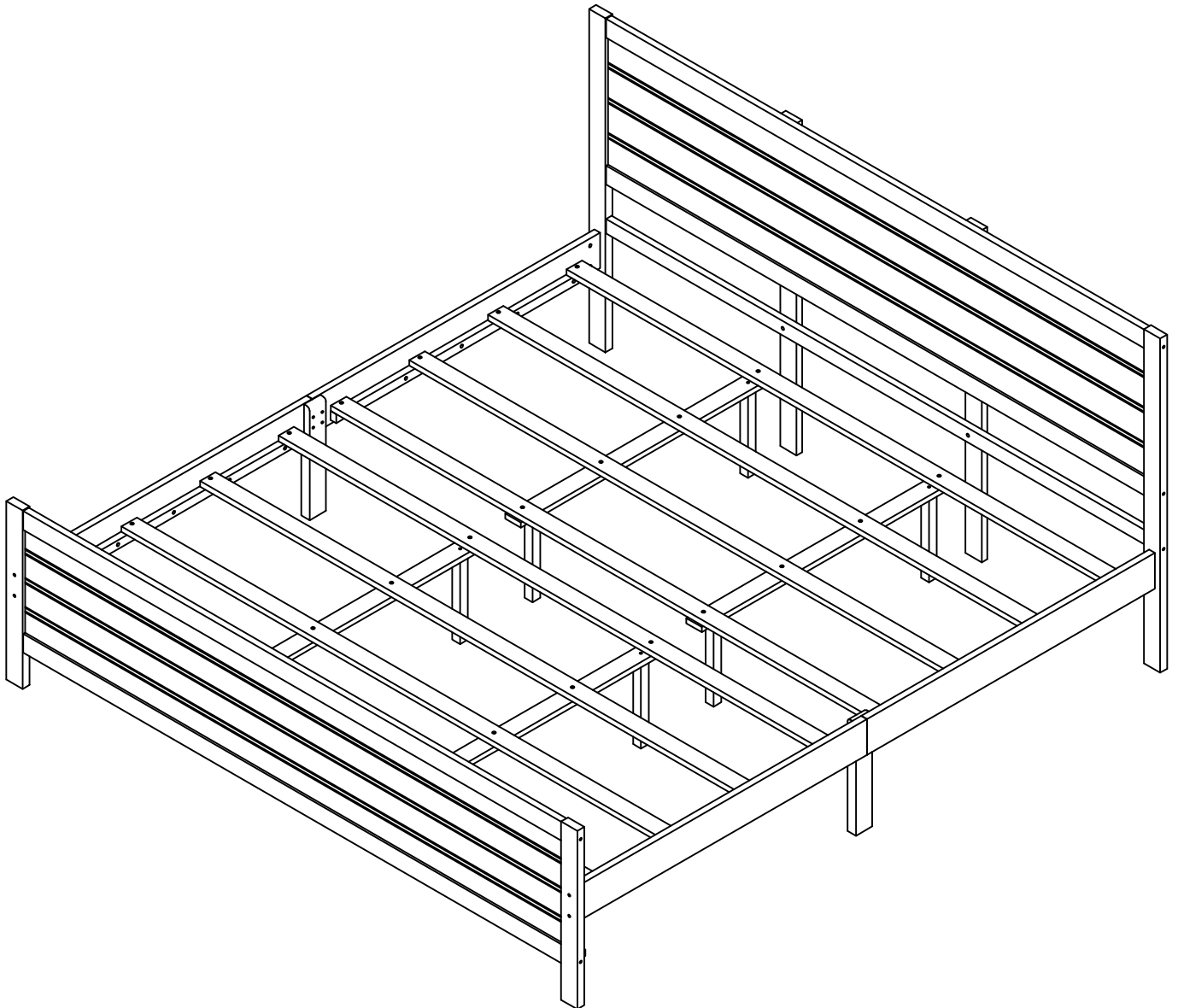





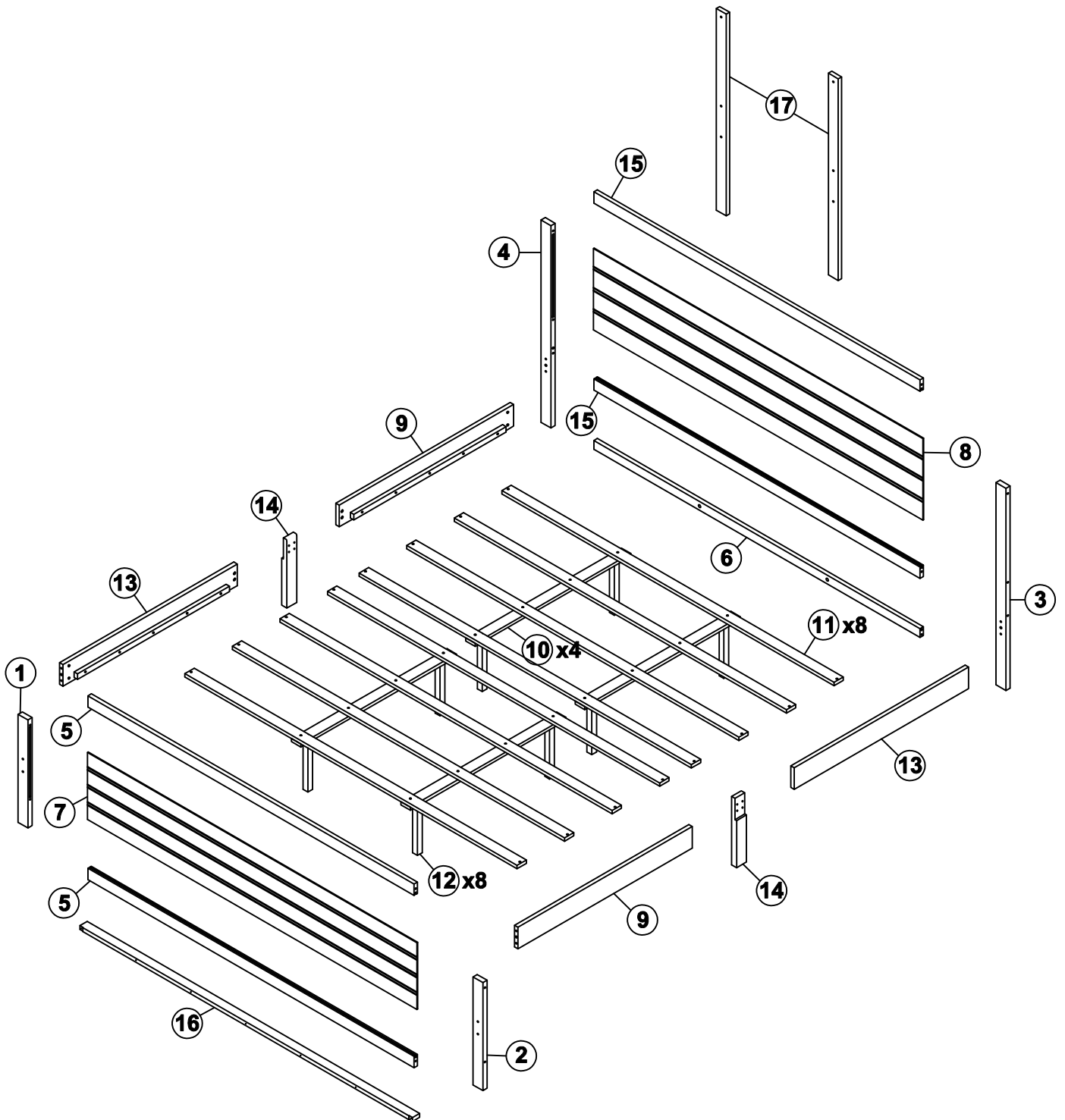



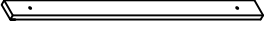

WF321012

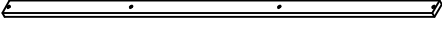
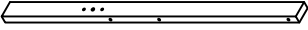
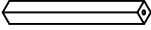
ASSEMBLY INSTRUCTIONS

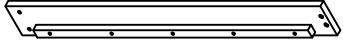

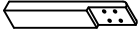
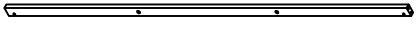
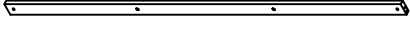
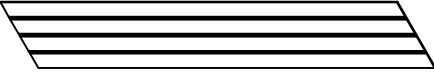

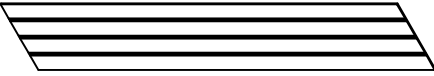
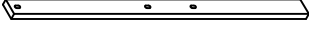







ASSEMBLY INSTRUCTIONS

WF321012

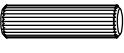
1	Leg		1pc		10	Center rails		4pcs
2	Leg		1pc		11	Slats		8pcs
3	Leg		1pc		12	Center rails legs support		8pcs
4	Leg		1pc		13	Side rails		2pcs
5	Foot board frames		2pcs		14	Center leg		2pcs
6	Headboard panel		1pc		15	Headboard frames		2pcs
7	Foot board panel		1pc		16	Foot board frames support		1pc
8	Headboard panel		1pc		17	Headboard leg		2pcs
9	Side rails		2pcs					

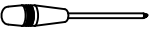

WF321012(Hardware in this SKU)

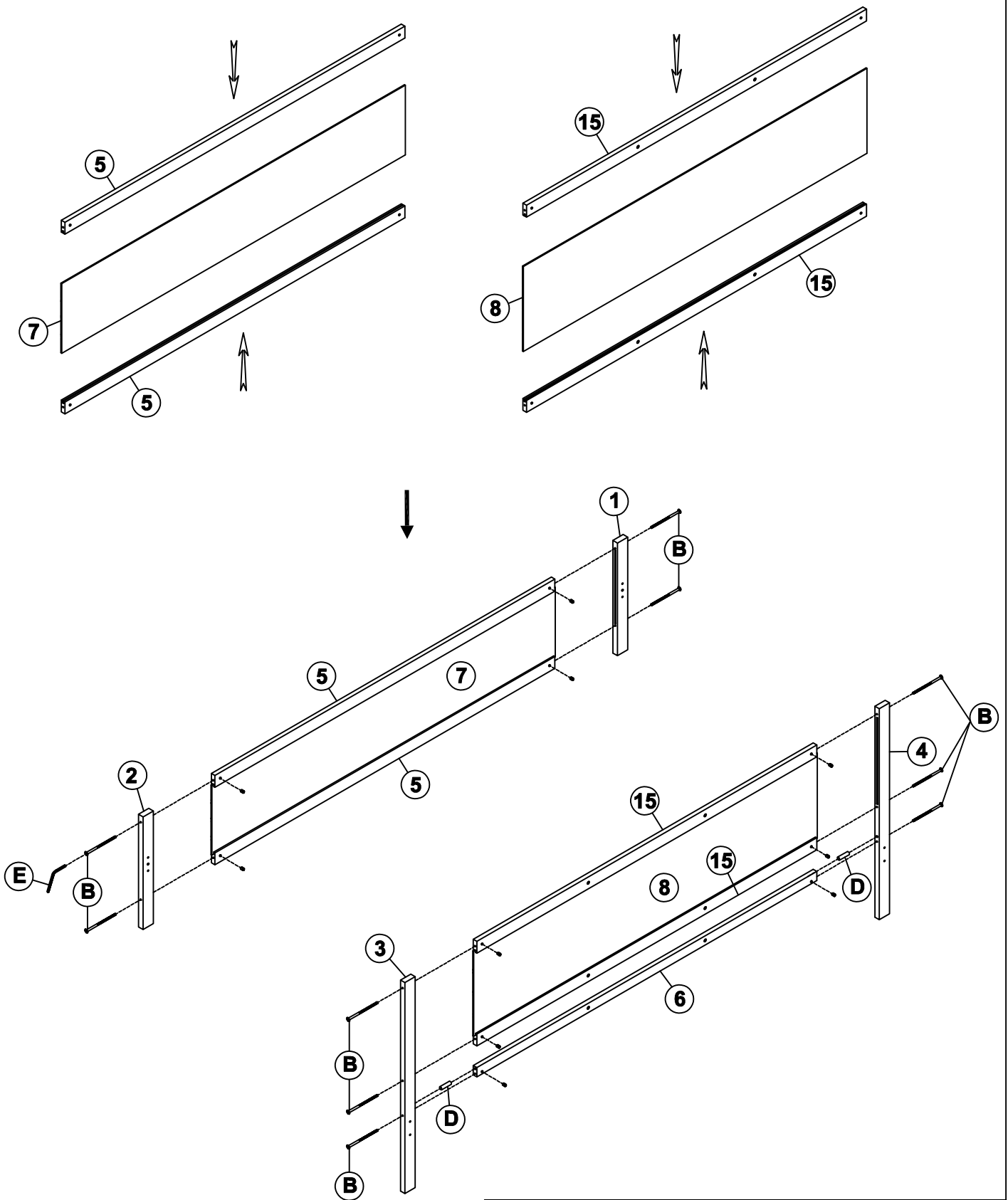

A	Ø4x30		32PCS		F	6.5x50		8PCS
B	1/4x100		10PCS		G	1/4x25		10PCS
C	1/4x65		8PCS		H	1/4x30		12PCS
D	Ø10x40		6PCS		I	1/4x35		2PCS
E	4x58		1PC		J	Ø4x25		7PCS
						Phillip head screw Not include		

ASSEMBLY INSTRUCTIONS

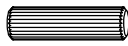
Step 1







D	Ø10x40		2PCS
E	4x58		1PC

B	1/4x100	 	10PCS
----------	---------	-------------------------------------------------------------------------------------------------------------------------------------------------------------------------	-------

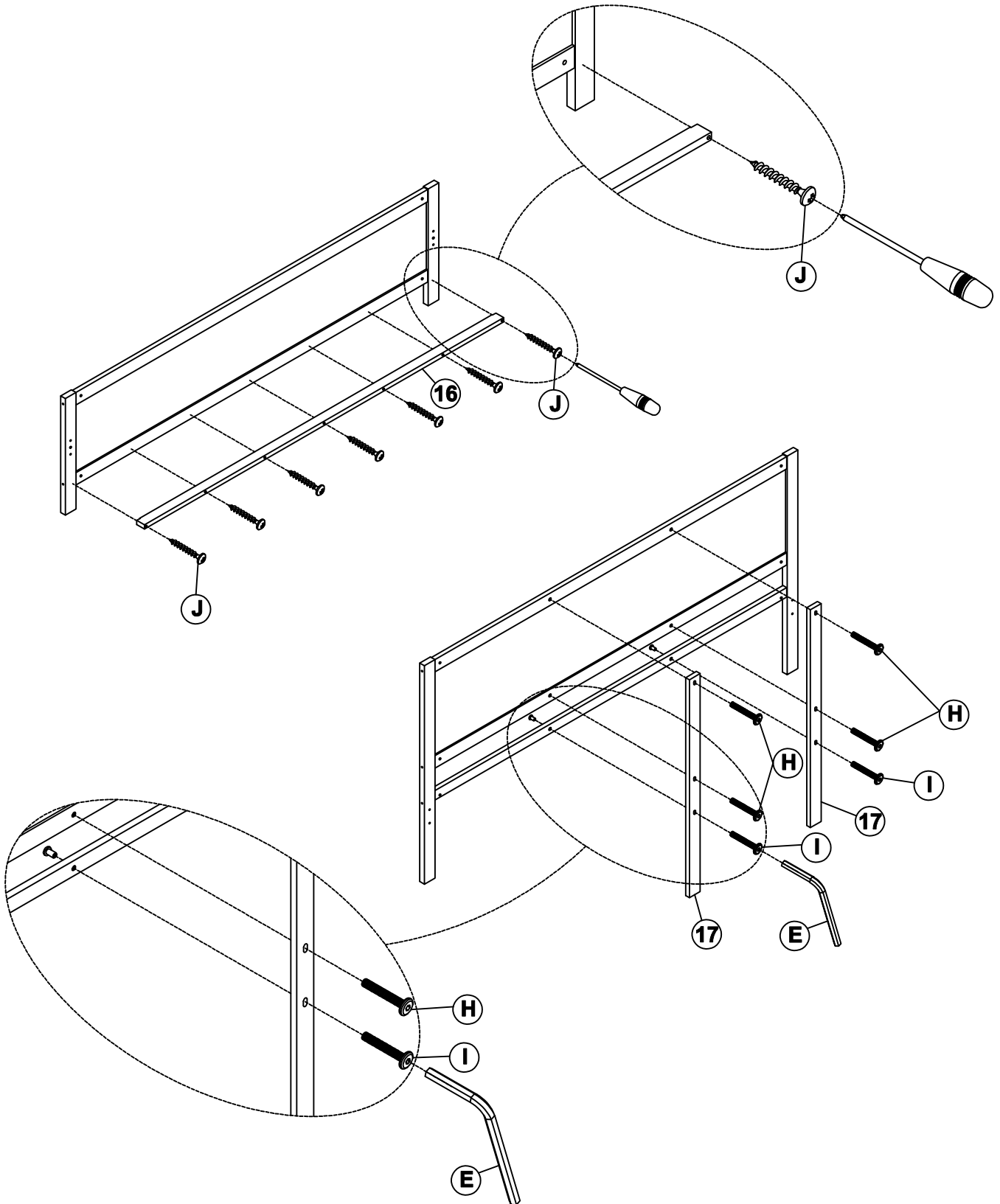
ASSEMBLY INSTRUCTIONS

Step 2



I	1/4x35		2PCS	H	1/4x30		4PCS
E	4x58		1PC	J	Ø4x25		7PCS

ASSEMBLY INSTRUCTIONS

Step 3

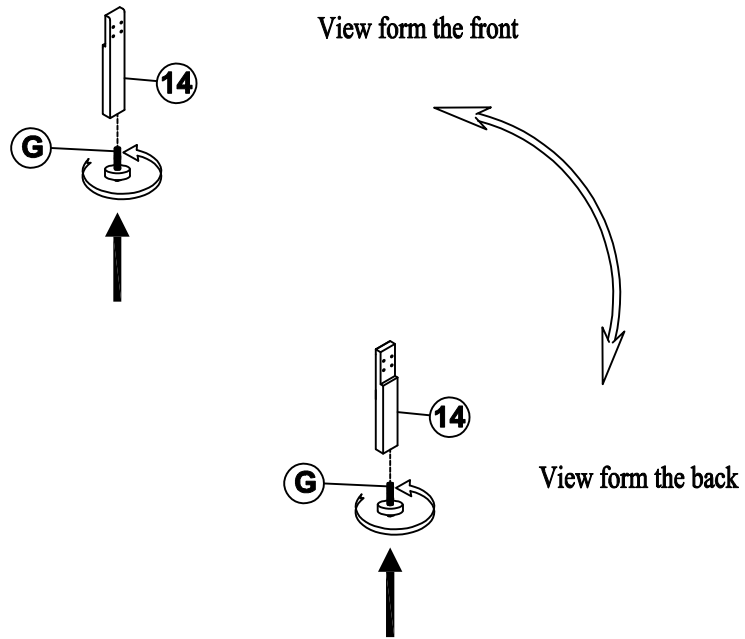

G 1/4x25



2PCS

Step 4

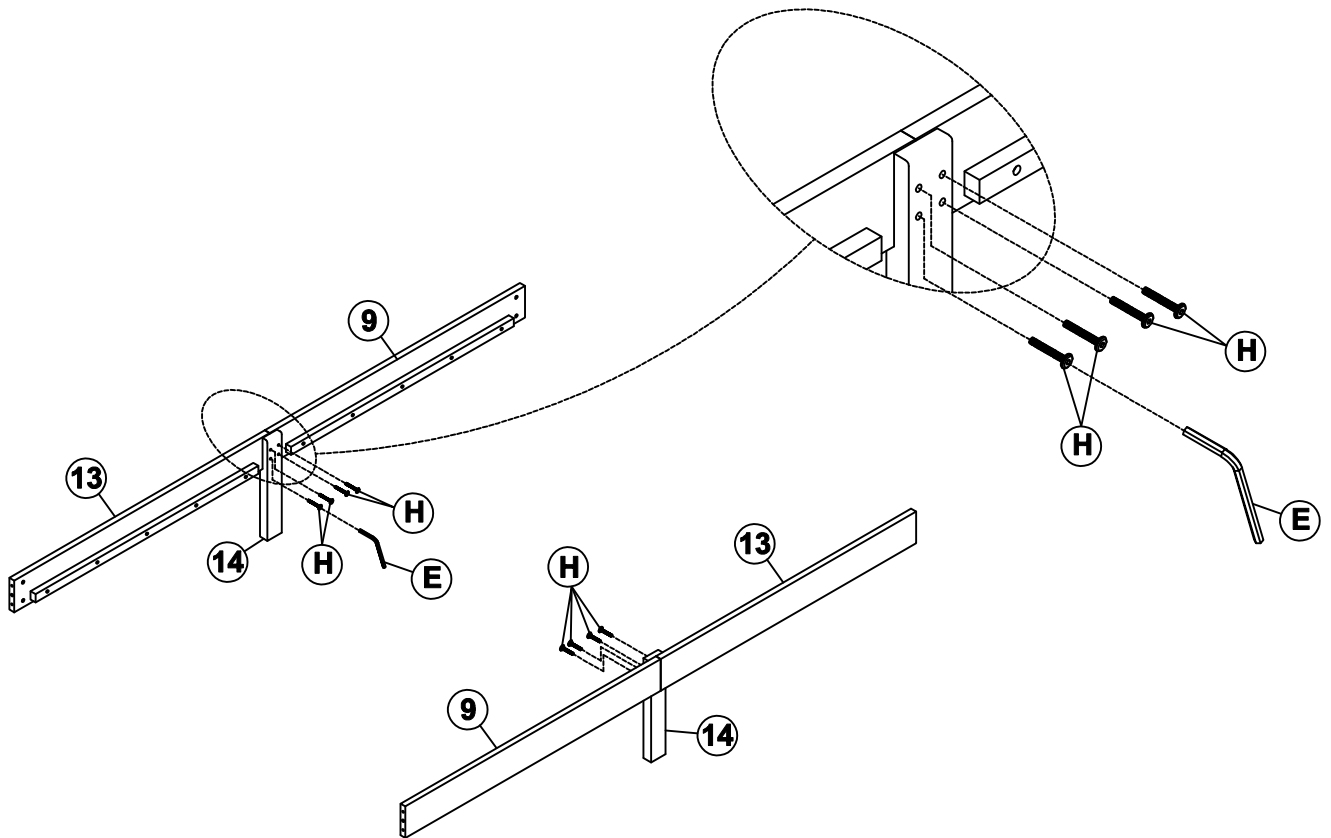

E 4x58



1PC

H 1/4x30





8PCS

ASSEMBLY INSTRUCTIONS

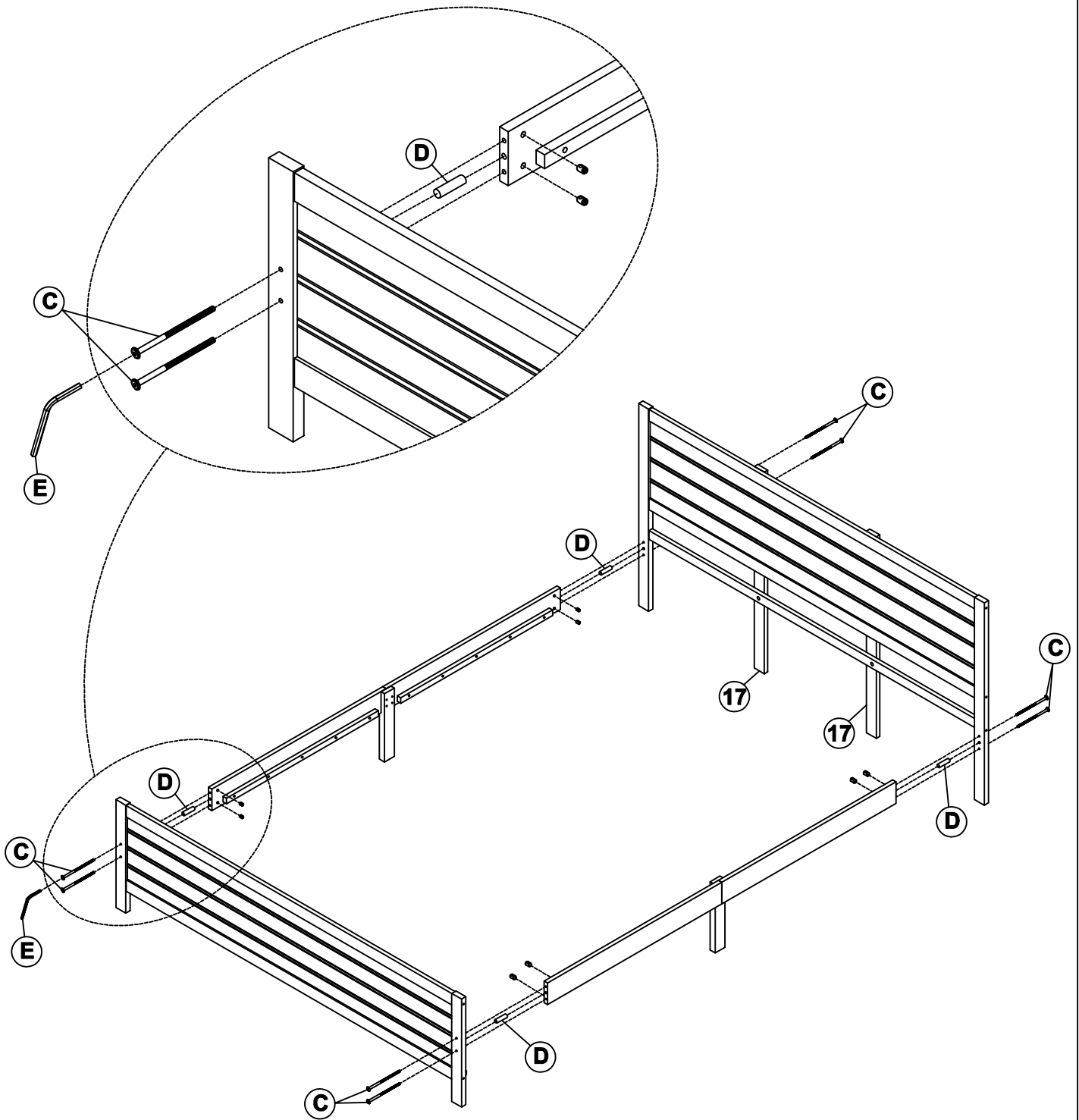
Step 5

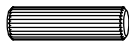



				D	Ø10x40		4PCS
C	1/4x65		8PCS	E	4x58		1PC

ASSEMBLY INSTRUCTIONS

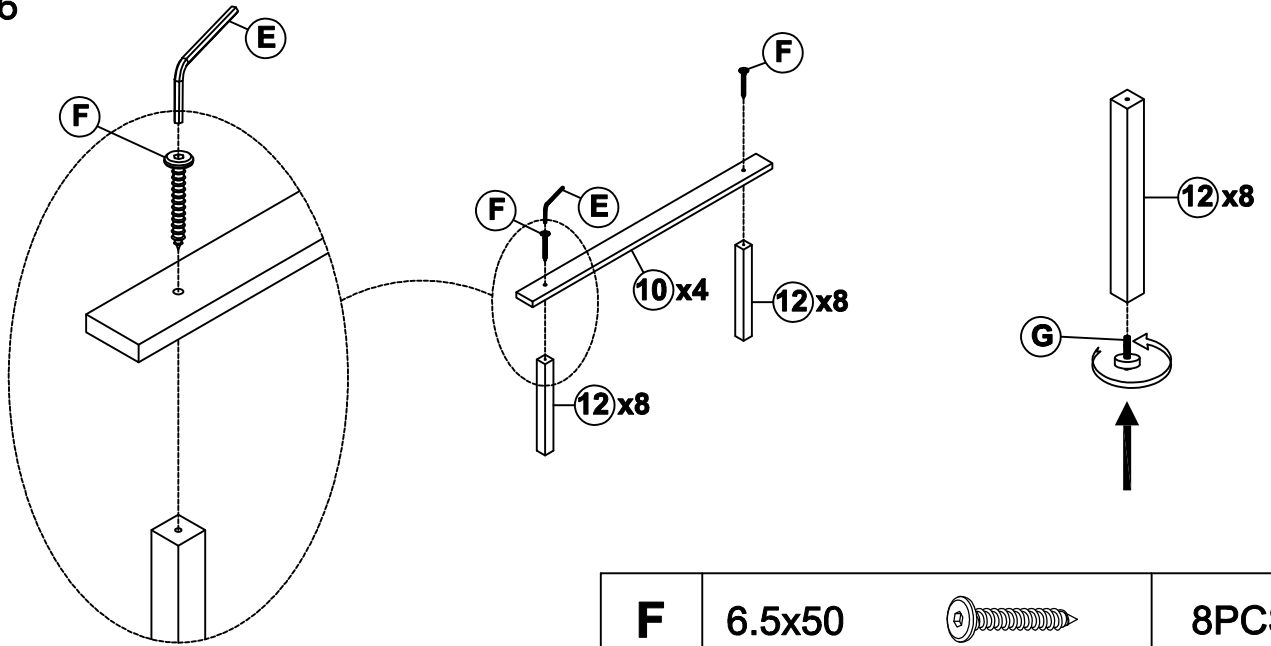
Step 6





F	6.5x50		8PCS
G	1/4x25		8PCS

E	4x58		1PC
----------	------	-----------------------------------------------------------------------------------	-----

Step 7

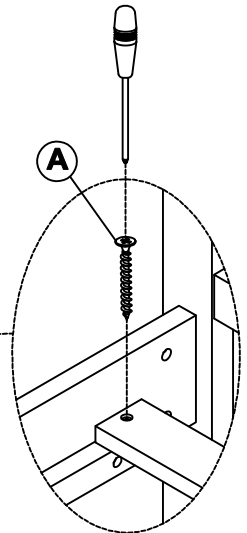
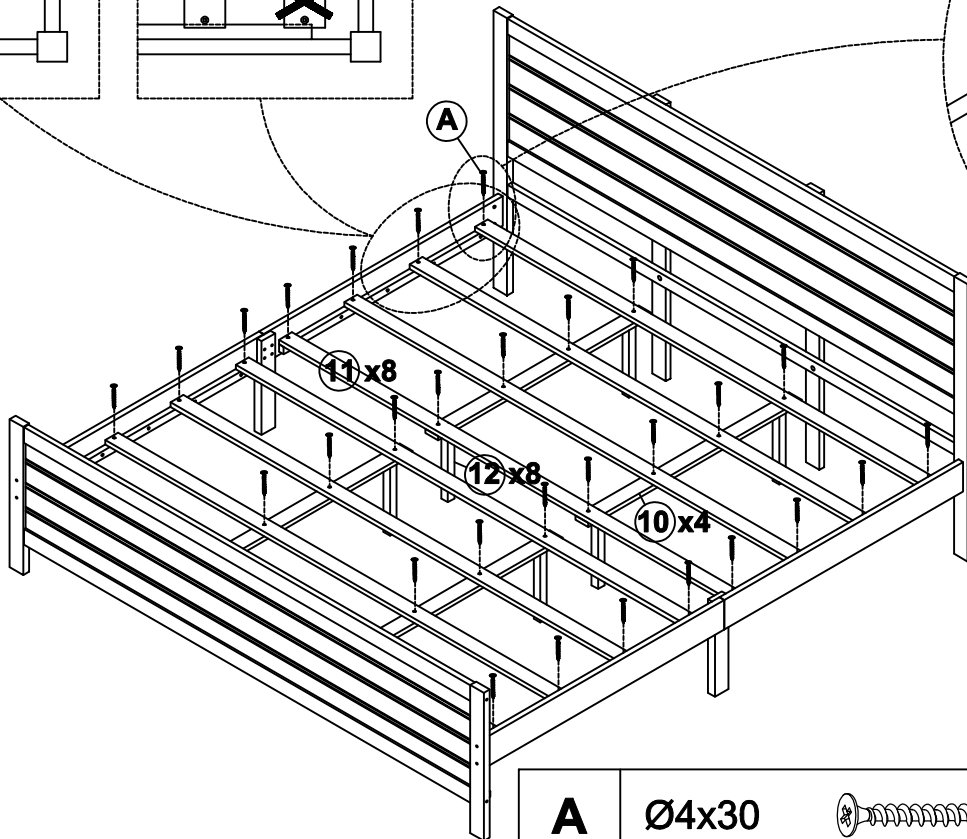
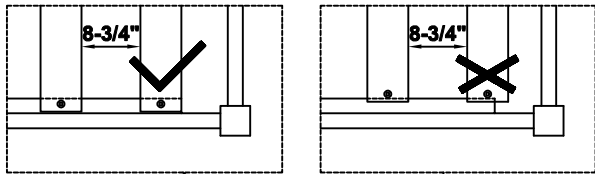
First attach 2pcs part 11 to the front and end of the frame between headboard. Then attach the remaining part 11 equidistantly between headboard



A	Ø4x30		32PCS
----------	-------	---------------------------------------------------------------------------------------	-------