

ASSEMBLY INSTRUCTIONS
Item No : WF316099 / WF316105
Description : TWIN BED

Thank you for purchasing this quality product. Be sure to check all packing material carefully for small part that may have come loose inside carton during shipment.

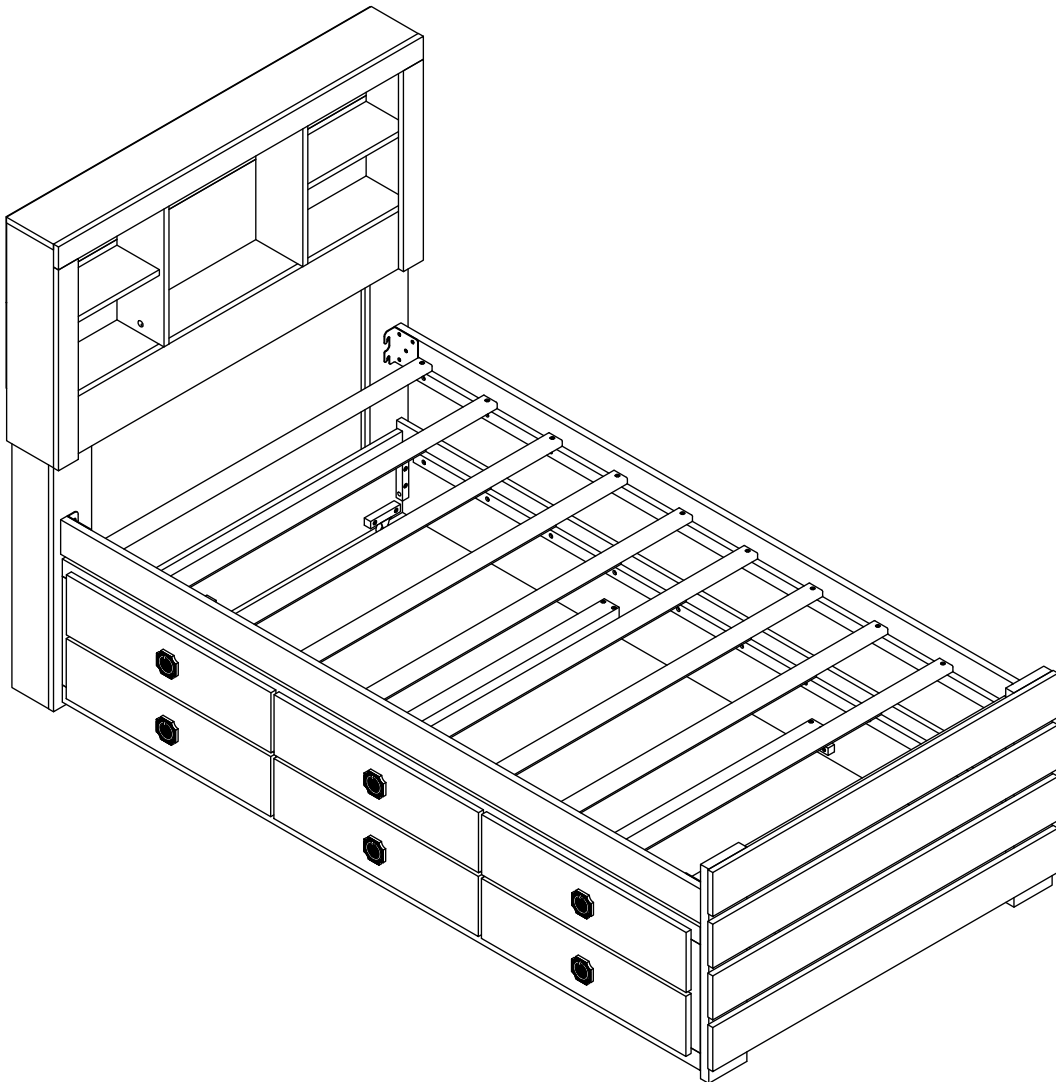





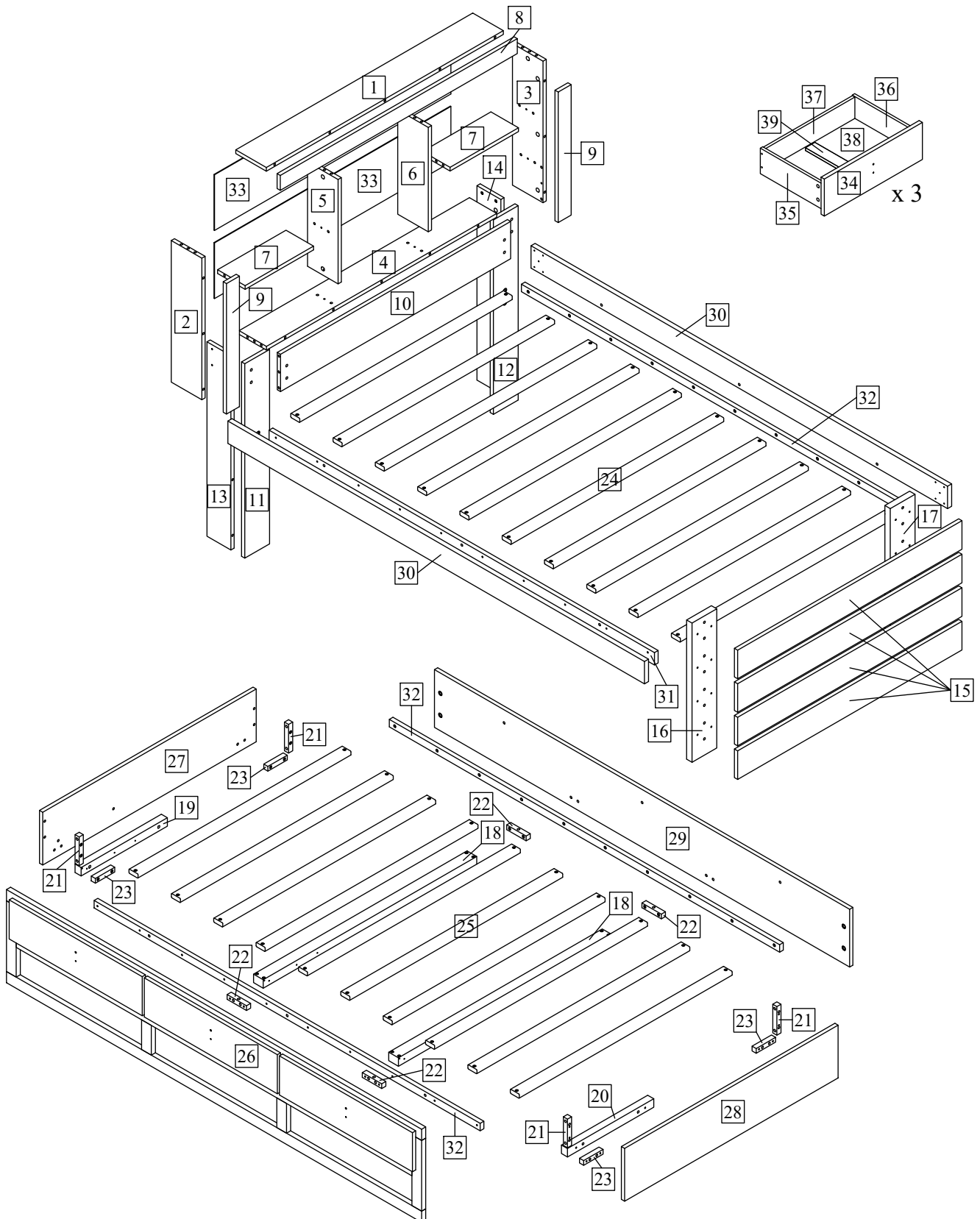























































ASSEMBLY INSTRUCTIONS
Item No : WF316099 / WF316105
Description : TWIN BED

Thank you for purchasing this quality product. Be sure to check all packing material carefully for small part that may have come loose inside carton during shipment.



ASSEMBLY INSTRUCTIONS
Item No : WF316099 / WF316105
Description : TWIN BED

Thank you for purchasing this quality product. Be sure to check all packing material carefully for small part that may have come loose inside carton during shipment.

Part List (Box 1)				Part List (Box 2)			
No.	Description	Sketch	Quantity	No.	Description	Sketch	Quantity
1	Headboard - Top Panel		1PC	26	Trundle - Front Frame		1PC
2	Headboard - Side Panel L		1PC	27	Trundle - Side Panel L		1PC
3	Headboard - Side Panel R		1PC	28	Trundle - Side Panel R		1PC
4	Headboard - Horizontal Panel		1PC	29	Trundle - Back Panel		1PC
5	Headboard - Center Panel L		1PC	30	Side Rail		2PCS
6	Headboard - Center Panel R		1PC	31	Slat Support - A		1PC
7	Headboard - Middle Panel		2PCS	32	Slat Support - B		3PCS
8	Headboard - Top Front Rail		1PC	33	Headboard - Back Panel		2PCS
9	Headboard - Side Front Rail		2PCS	34	Drawer Front		3PCS
10	Headboard - Lower Front Rail		1PC	35	Drawer Side - L		3PCS
11	Headboard Leg - Front Panel L		1PC	36	Drawer Side - R		3PCS
12	Headboard Leg - Front Panel R		1PC	37	Drawer Back		3PCS
13	Headboard Leg - Side Panel L		1PC	38	Drawer Bottom		3PCS
14	Headboard Leg - Side Panel R		1PC	39	Drawer Bottom Support		3PCS
15	Footboard - Middle Panel		4PCS	40	PVC H		1PC
16	Footboard - Side Panel L		1PC	Hardware List (Box 1)			
17	Footboard - Side Panel R		1PC	No.	Description	Sketch	Quantity
18	Drawer Slide Support Long		2PCS	A	Minifix Bolt		56PCS
19	Drawer Slide Support Short - L		1PC	B	Minifix Cam (Ø15mm)		38PCS
20	Drawer Slide Support Short - R		1PC	C	Minifix Cam (Ø12mm)		18PCS
21	Side Support Cube		4PCS	D	Wood Dowel M8 x 25mm		88PCS
22	Drawer Slide Support Cube		4PCS	E	Allen Key M4		1PC
23	Roller Support Cube		4PCS	F	Allen Key M5		1PC
24	Bed Slat (Twin)		1SET	G	JCBB M8 x 20mm		8PCS
25	Trundle Bed Slat (Twin)		1SET	H	JCBC M6 x 30mm		12PCS
TOOLS REQUIRED (Not provided)				I	Spring Washer M6		12PCS
 Screwdriver				J	Flat Washer M6		12PCS
				K	CSK Screw M3.5 x 12mm		58PCS
				L	CSK Screw M4 x 32mm		58PCS
				M	Panhead Screw M4 x 12mm		26PCS
				N	Panhead Screw M4 x 25mm		34PCS
				O	Panhead Screw M4 x 30mm		62PCS
				P	Handle Screw M4 x 10mm		6PCS
				Q	Handle		6PCS
				R	Bed Bracket L/R		4PCS
				S	Drawer Slide 12" S1 (L/R) S2 (L/R)		3SETS
				T	Roller		4PCS

ASSEMBLY INSTRUCTIONS



Item No : WF316099 / WF316105

Description : TWIN BED

Thank you for purchasing this quality product. Be sure to check all packing material carefully for small part that may have come loose inside carton during shipment.

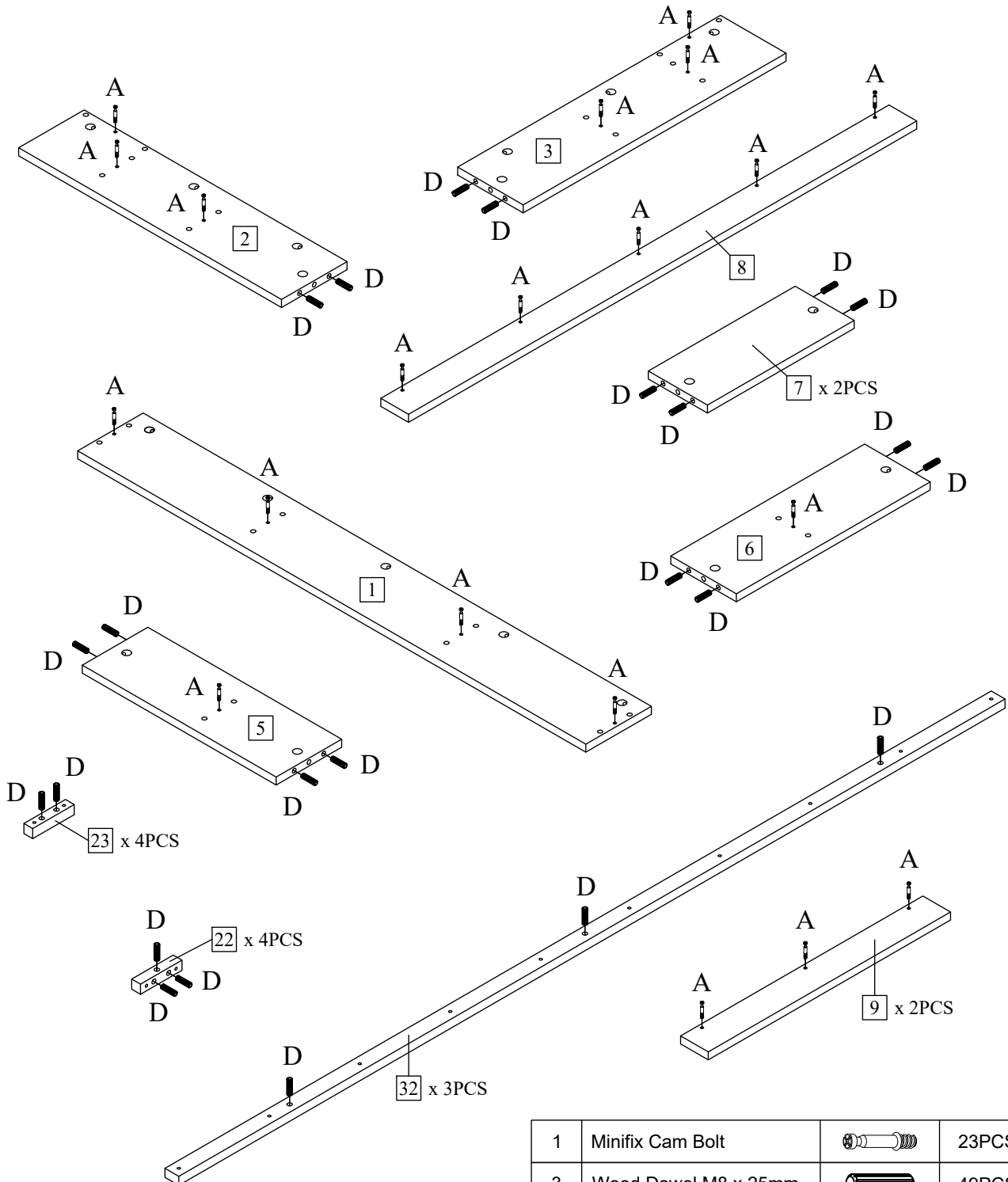
Step 1 : Attach Minifix Bolt (A) to Headboard - Top Panel (1), Headboard - Side Panel L (2), Headboard - Side Panel R (3), Headboard - Center Panel L (5), Headboard - Center Panel R (6), Headboard - Middle Panel (7), Headboard - Top Front Rail (8), Headboard - Side Front Rail (9). Attach Wood Dowel M8 x 25mm (D) to Headboard - Side Panel L (2), Headboard - Side Panel R (3), Headboard - Center Panel L (5), Headboard - Center Panel R (6), Headboard - Middle Panel (7), Drawer Slide Support Cube (22), Roller Support Cube (23), Slat Support - B (32).

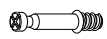

1	Minifix Cam Bolt		23PCS
3	Wood Dowel M8 x 25mm		49PCS

ASSEMBLY INSTRUCTIONS



Item No : WF316099 / WF316105

Description : TWIN BED

Thank you for purchasing this quality product. Be sure to check all packing material carefully for small part that may have come loose inside carton during shipment.

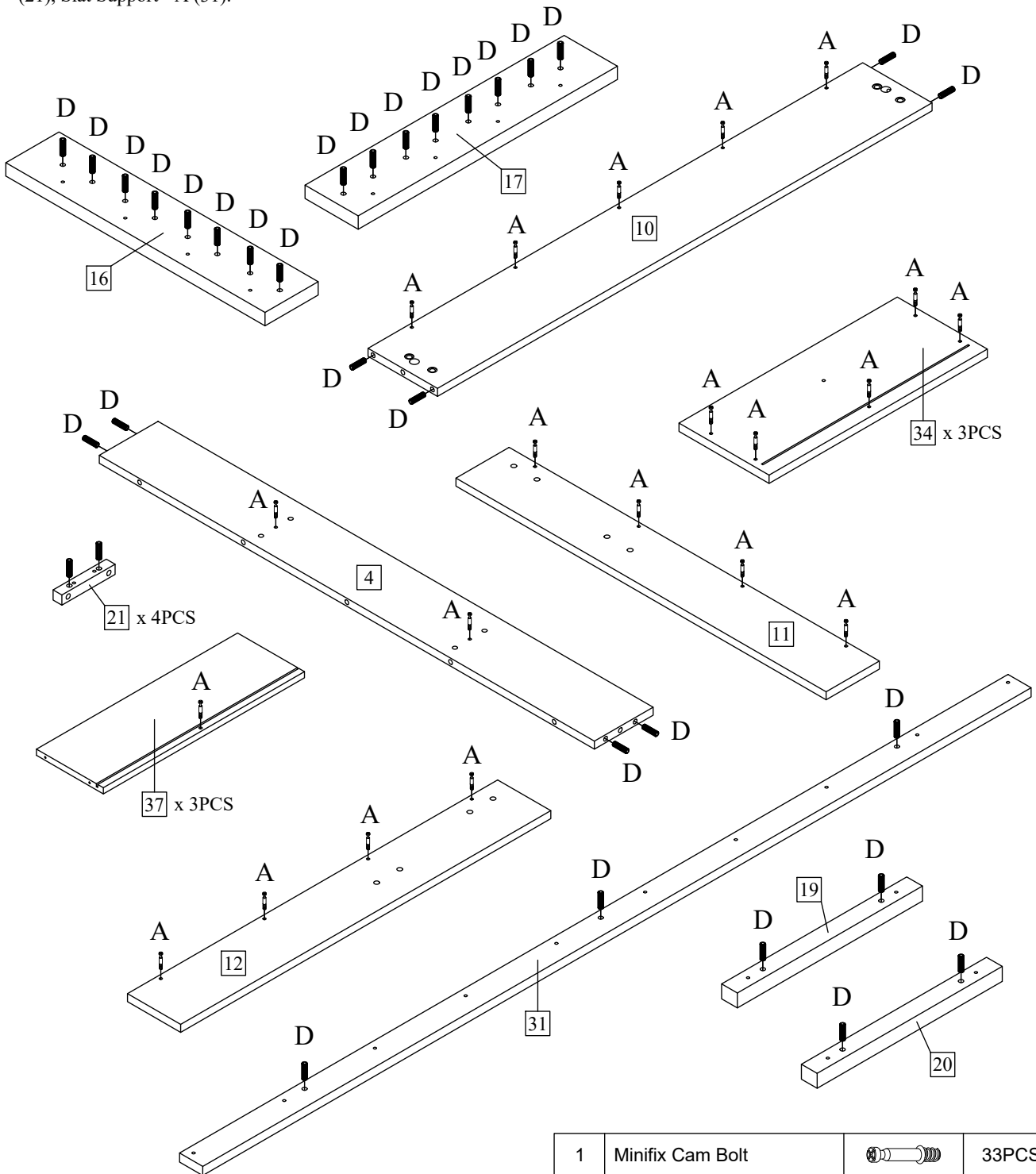
Step 2 : Attach Minifix Bolt (A) to Headboard - Horizontal Panel (4), Headboard - Lower Front Rail (10), Headboard Leg - Front Panel L (11), Headboard Leg - Front Panel R (11), Drawer Front Panel (34), Drawer Back Panel (37). Attach Wood Dowel M8 x 25mm (D) to Headboard - Horizontal Panel (4), Headboard - Lower Front Rail (10), Footboard - Side Panel L (16), Footboard - Side Panel R (16), Drawer Slide Support Short - L (19), Drawer Slide Support Short - R (20), Side Support Cube (21), Slat Support - A (31).

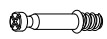

1	Minifix Cam Bolt		33PCS
3	Wood Dowel M8 x 25mm		39PCS

ASSEMBLY INSTRUCTIONS
Item No : WF316099 / WF316105
Description : TWIN BED

Thank you for purchasing this quality product. Be sure to check all packing material carefully for small part that may have come loose inside carton during shipment.

Step 3 : Connect the Headboard - Top Front Rail (8) to the Headboard - Top Panel (1) and lock Minifix Cam (B).

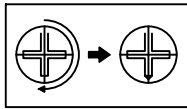
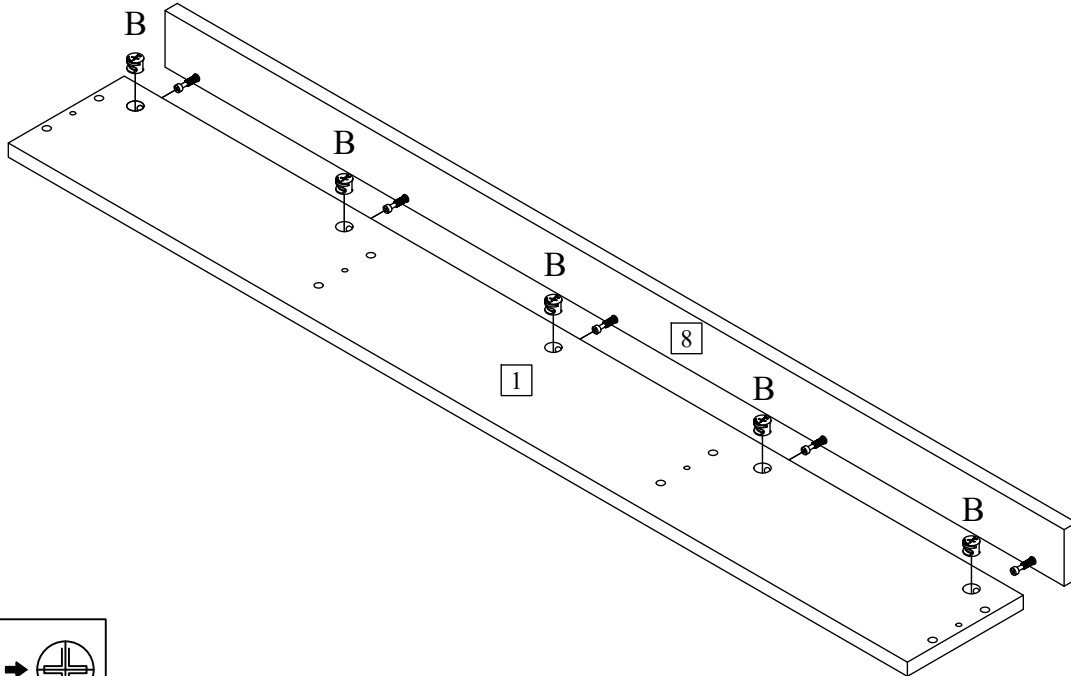

Lock Minifix Cam clockwise

B	Minifix Cam (Ø15mm)		5PCS
---	---------------------	---	------

Step 4 : Connect the Headboard - Side Front Rail (9) to the Headboard - Side Panel L (2) and lock Minifix Cam (B).

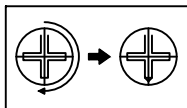
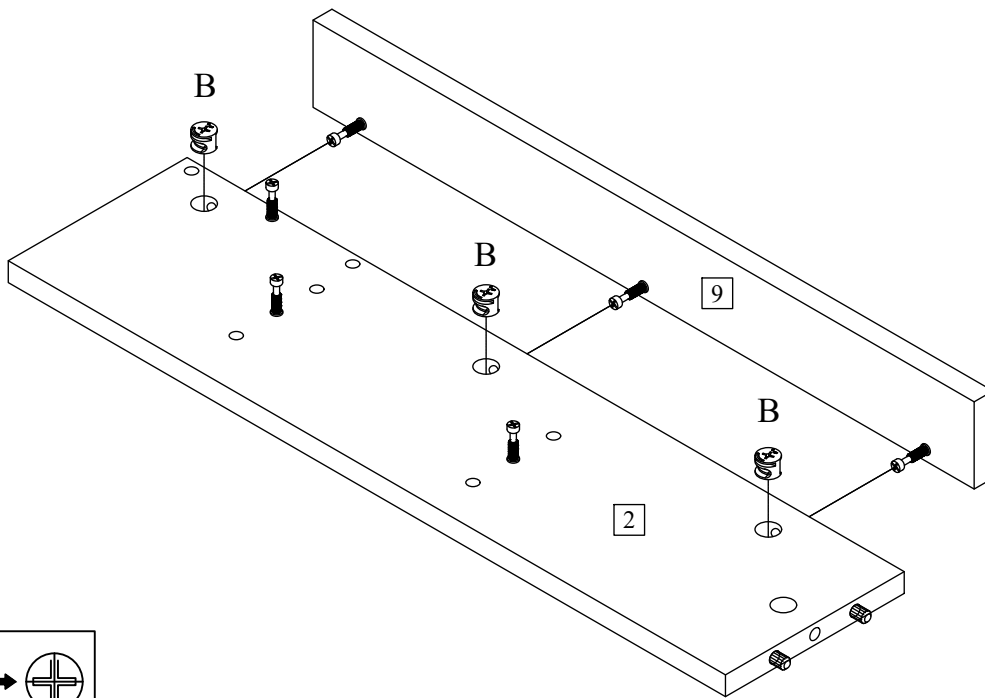

Lock Minifix Cam clockwise

B	Minifix Cam (Ø15mm)		3PCS
---	---------------------	---	------

ASSEMBLY INSTRUCTIONS
Item No : WF316099 / WF316105
Description : TWIN BED

Thank you for purchasing this quality product. Be sure to check all packing material carefully for small part that may have come loose inside carton during shipment.

Step 5 : Connect the Headboard - Side Front Rail (9) to the Headboard - Side Panel R (3) and lock Minifix Cam (B).

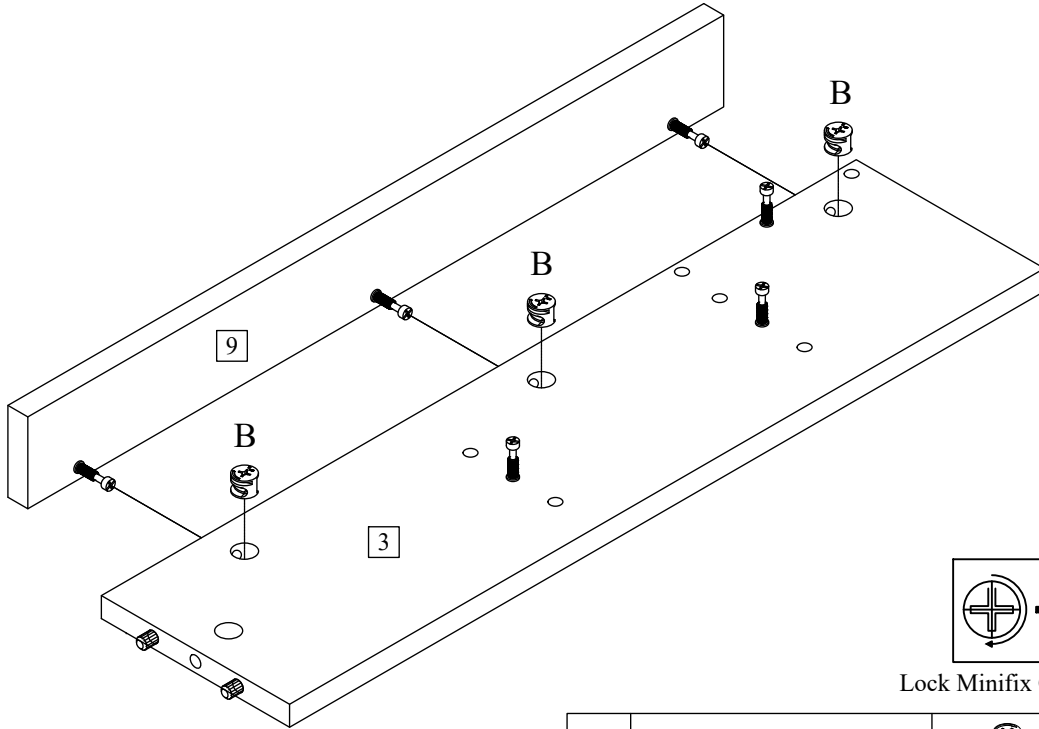

Lock Minifix Cam clockwise

B	Minifix Cam (Ø15mm)		3PCS
---	---------------------	---	------

Step 6 : Connect the Headboard - Lower Front Rail (10) to the Headboard - Horizontal Panel (4) and lock Minifix Cam (B).

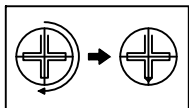
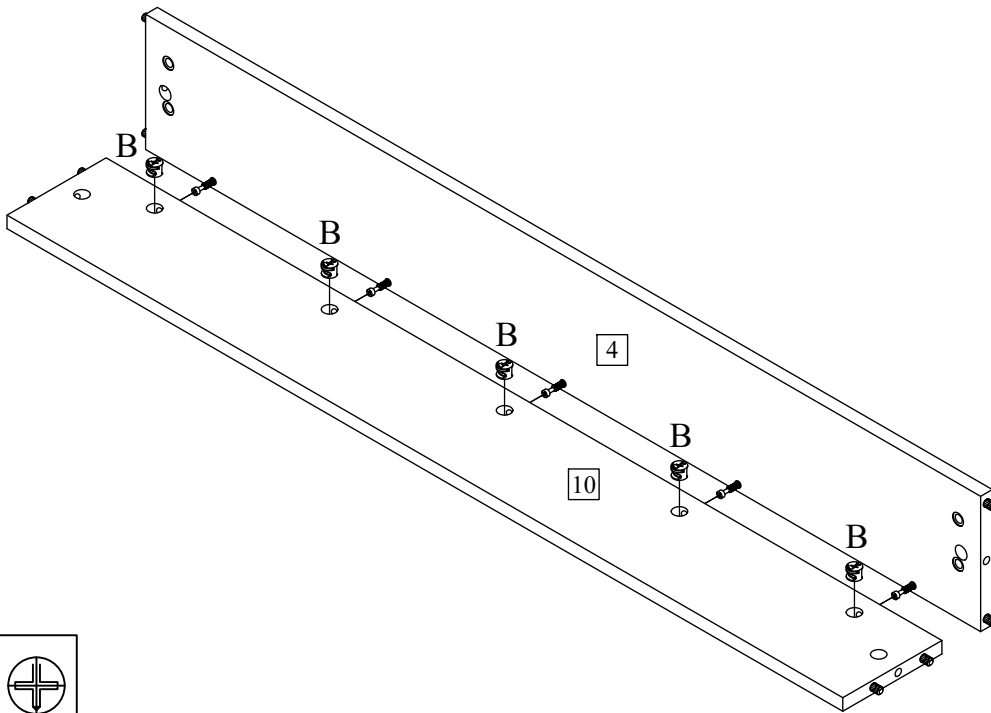

Lock Minifix Cam clockwise

B	Minifix Cam (Ø15mm)		5PCS
---	---------------------	---	------

ASSEMBLY INSTRUCTIONS
Item No : WF316099 / WF316105
Description : TWIN BED

Thank you for purchasing this quality product. Be sure to check all packing material carefully for small part that may have come loose inside carton during shipment.

Step 7 : Connect the Headboard - Horizontal Panel (4) and Headboard - Middle Panel (7) to the Headboard - Center Panel L (5) and Headboard - Center Panel R (6) then lock Minifix Cam (B).

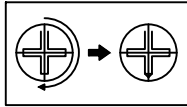
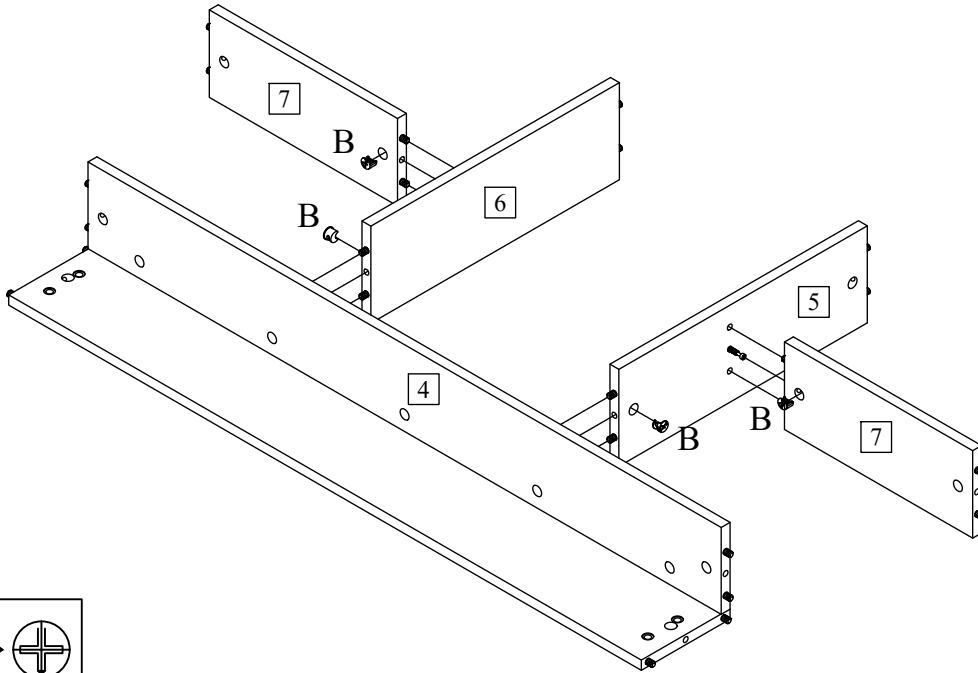

Lock Minifix Cam clockwise

B	Minifix Cam (Ø15mm)		4PCS
---	---------------------	---	------

Step 8 : Connect the Headboard - Side Panel L (2) and Headboard - Side Panel R (3) to the Headboard - Horizontal Panel (4), Headboard - Middle Panel (7) and Headboard - Lower Front Rail (10) then lock Minifix Cam (B).

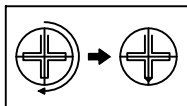
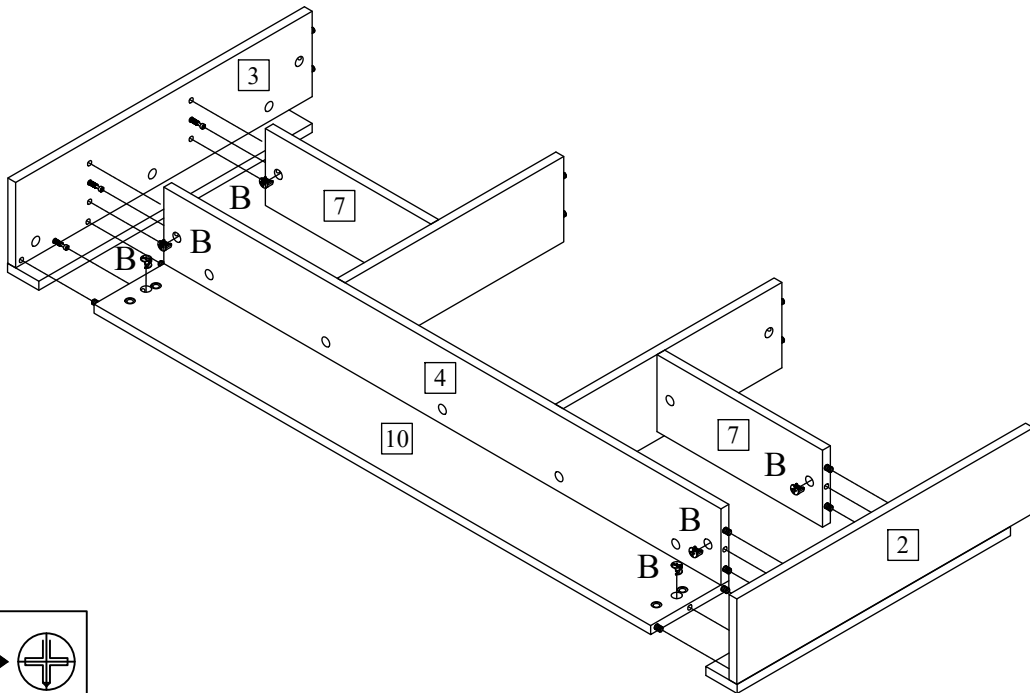

Lock Minifix Cam clockwise

B	Minifix Cam (Ø15mm)		6PCS
---	---------------------	---	------

ASSEMBLY INSTRUCTIONS
Item No : WF316099 / WF316105
Description : TWIN BED

Thank you for purchasing this quality product. Be sure to check all packing material carefully for small part that may have come loose inside carton during shipment.

Step 9 : Connect the Headboard - Top Panel (1) to the Headboard - Side Panel L (2), Headboard - Side Panel R (3), Headboard-Center Panel L (5) and Headboard - Center Panel R (6) then lock Minifix Cam (B).

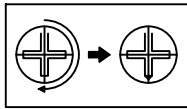
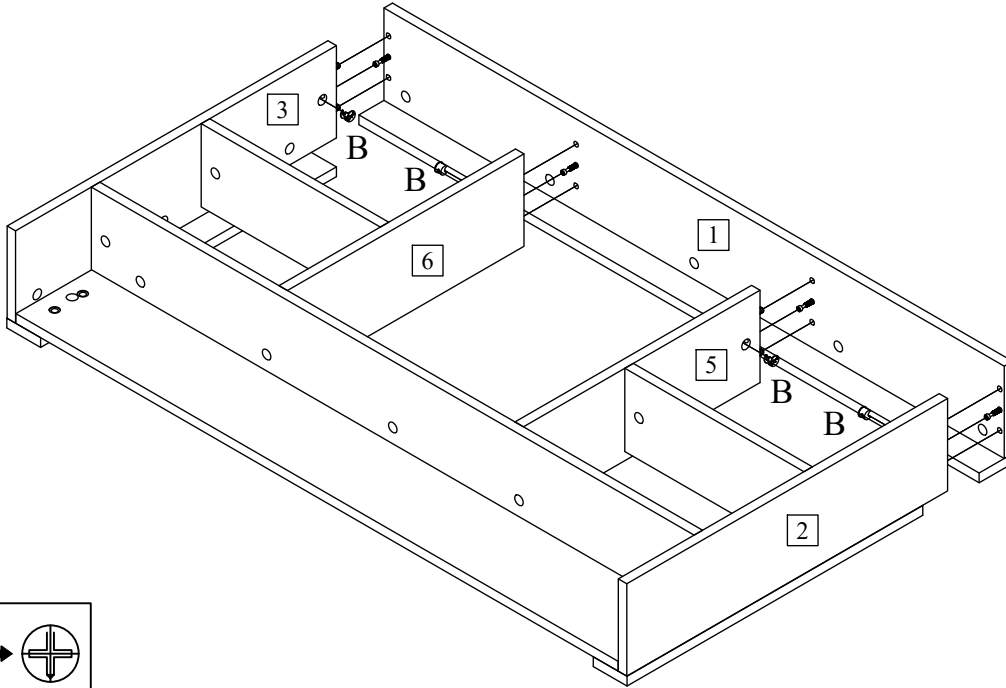

Lock Minifix Cam clockwise

B	Minifix Cam (Ø15mm)		4PCS
---	---------------------	---	------

Step 10 : Connect the Headboard Leg - Side Panel L (13) to the Headboard Leg - Front Panel L (11) and lock Minifix Cam (B).

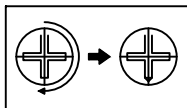
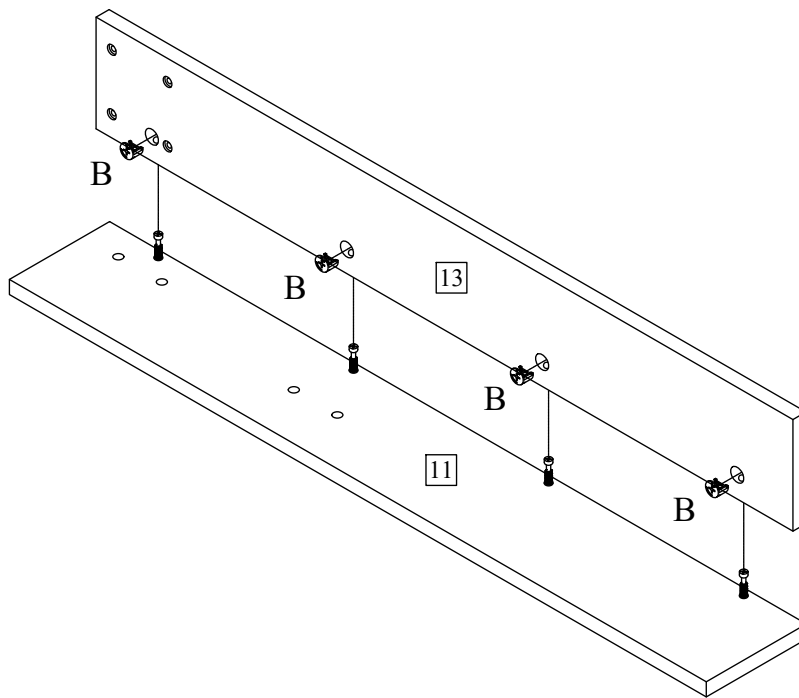

Lock Minifix Cam clockwise

B	Minifix Cam (Ø15mm)		4PCS
---	---------------------	---	------

ASSEMBLY INSTRUCTIONS
Item No : WF316099 / WF316105
Description : TWIN BED

Thank you for purchasing this quality product. Be sure to check all packing material carefully for small part that may have come loose inside carton during shipment.

Step 11 : Connect the Headboard Leg - Side Panel R (14) to the Headboard Leg - Front Panel R (12) and lock Minifix Cam (B).

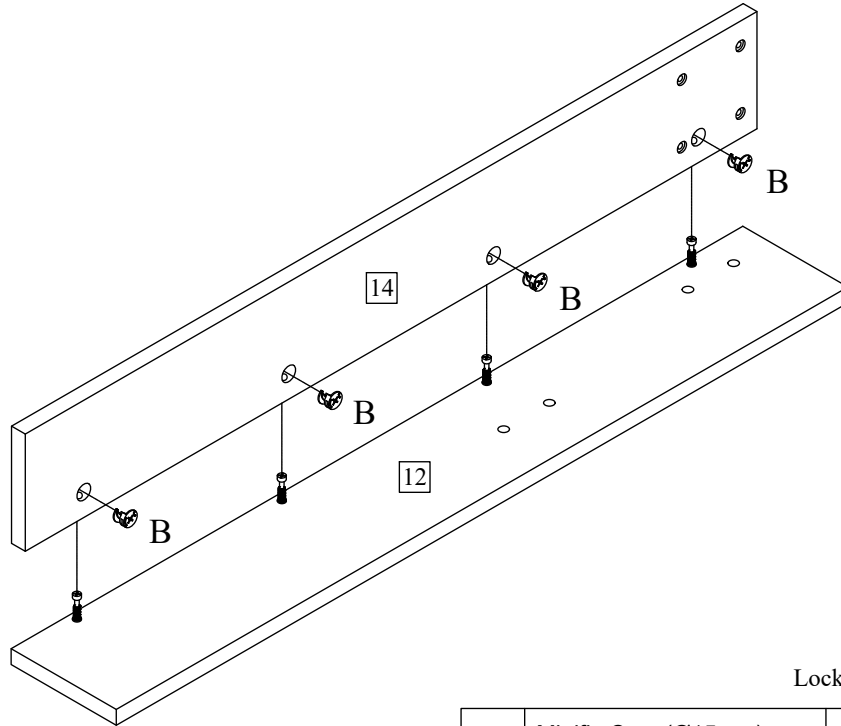



Lock Minifix Cam clockwise

B	Minifix Cam (Ø15mm)		4PCS
---	---------------------	---	------

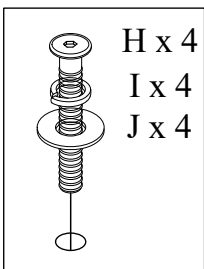
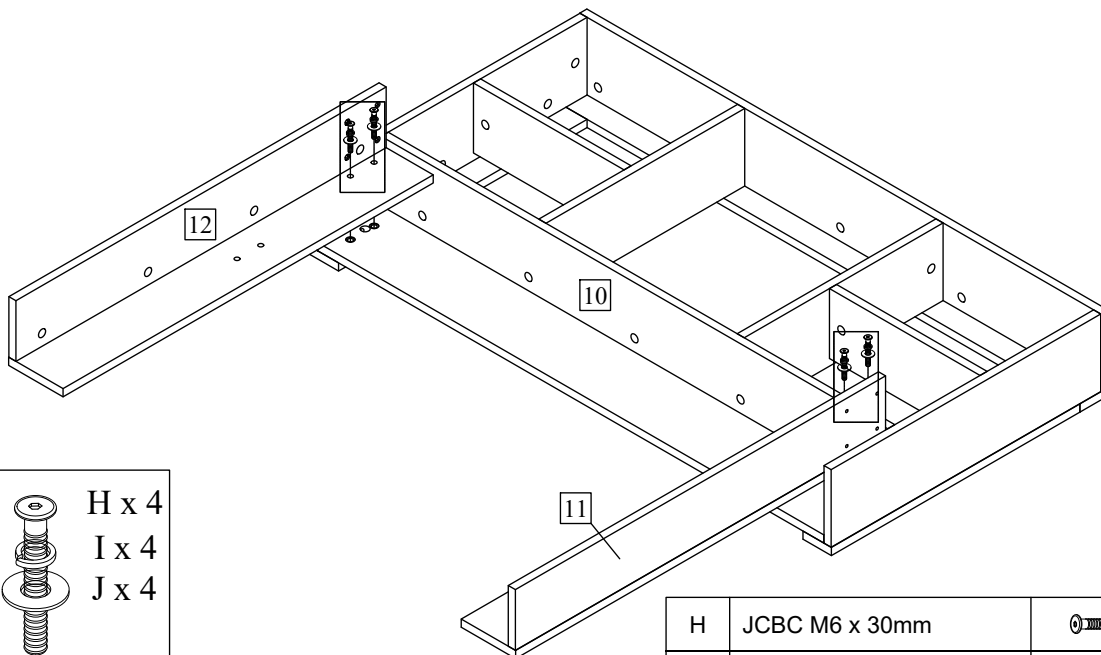
Step 12 : Connect the Headboard Leg - Front Panel L (11) and Headboard Leg - Front Panel R (12) to the Headboard - Lower Front Rail (10) using Allen Key M4 (E) with JCBC M6 x30mm (H), Spring Washer M6 (I) and Flat Washer M6 (J).







H	JCBC M6 x 30mm		4PCS
I	Spring Washer M6		4PCS
J	Flat Washer M6		4PCS

ASSEMBLY INSTRUCTIONS
Item No : WF316099 / WF316105
Description : TWIN BED

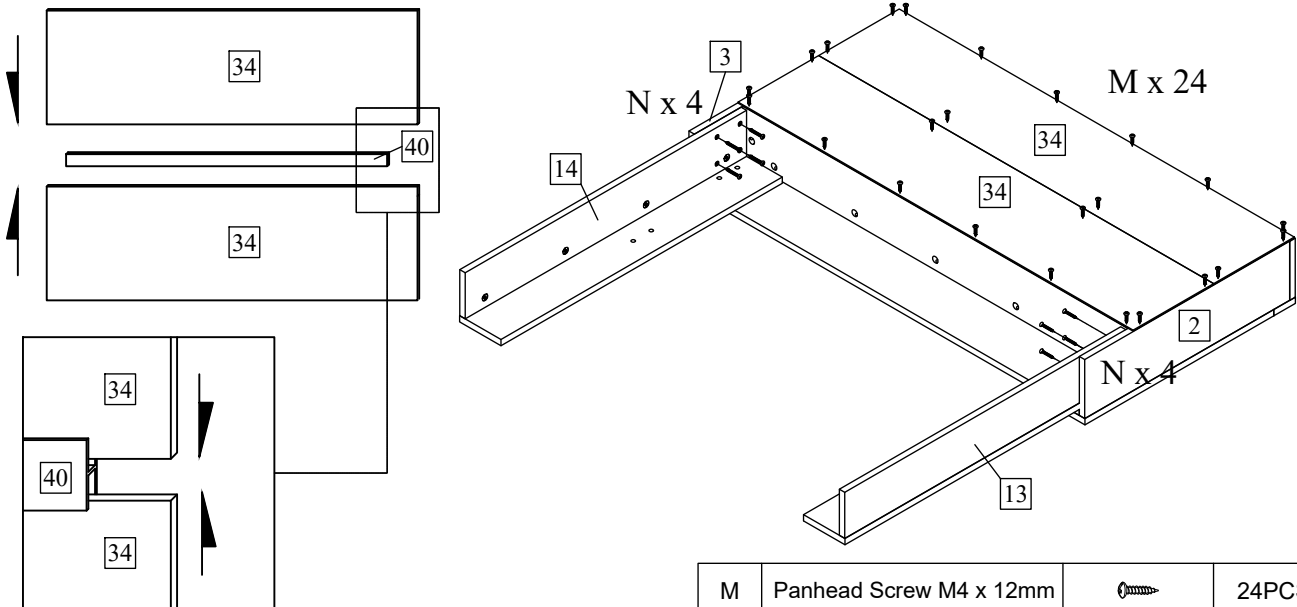
Thank you for purchasing this quality product. Be sure to check all packing material carefully for small part that may have come loose inside carton during shipment.

Step 13 : Attach Back Panel (34) to PVC H (40). Then, insert the Back Panel (34) from behind Headboard using Panhead Screw M4 x 12MM (M). Connect the Headboard Leg - Side Panel L (13) and Headboard Leg - Side Panel R (14) to the Headboard - Side Panel L (2) and Headboard - Side Panel R (3) with Panhead Screw M4 x 25mm (N).



M	Panhead Screw M4 x 12mm		24PCS
N	Panhead Screw M4 x 25mm		8PCS
40	PVC H		1PC

Step 14 : Connect the Footboard - Side Panel L (16) and Footboard - Side Panel R (17) to the Footboard - Middle Panel (15) with Panhead M4 x30mm (O).

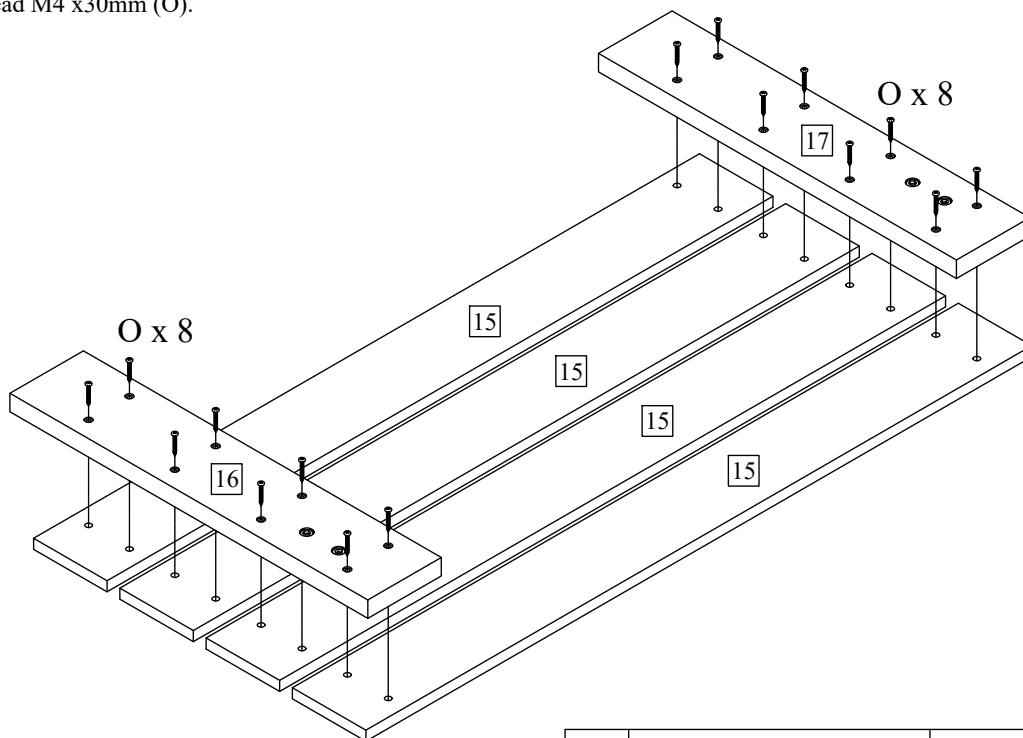

O	Panhead Screw M4 x 30mm		16PCS
---	-------------------------	---	-------

ASSEMBLY INSTRUCTIONS
Item No : WF316099 / WF316105
Description : TWIN BED

Thank you for purchasing this quality product. Be sure to check all packing material carefully for small part that may have come loose inside carton during shipment.

Step 15 : Connect the Slat Support - A (31) and Slat Support - B (32) to the Side Rail (30) with Panhead M4 x30mm (O). Attach Bed Bracket L/R (R) to the Side Rail (30) with CSK Screw M3.5 x 12mm (K).

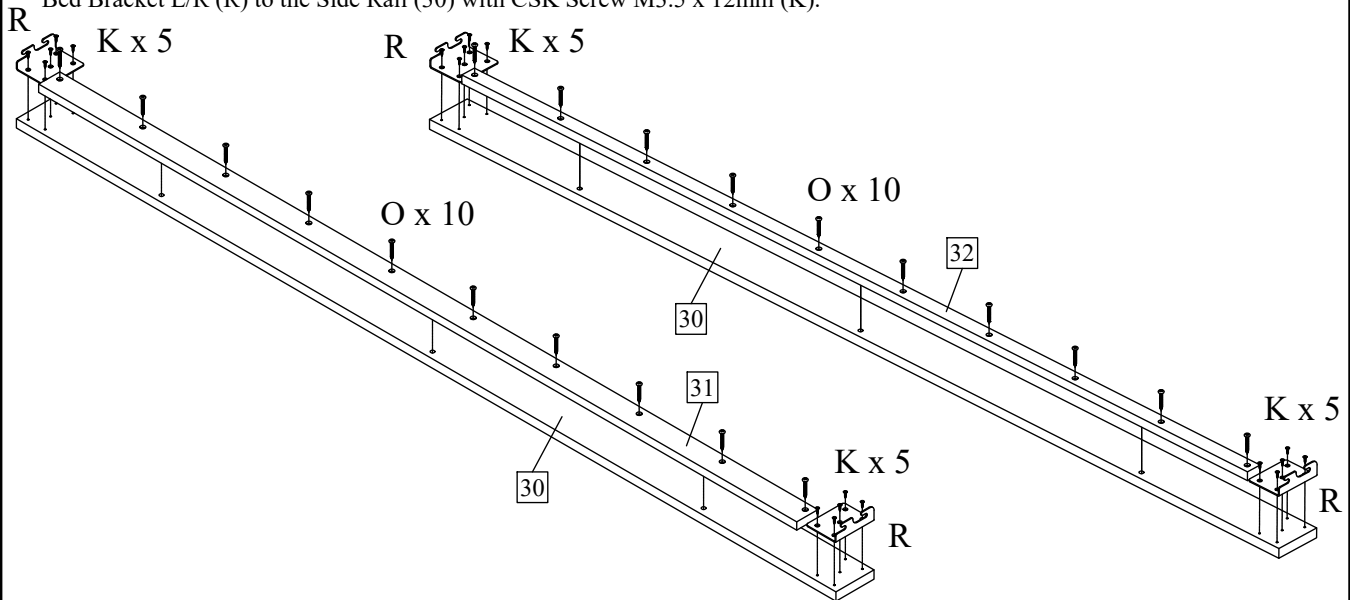

K	CSK Screw M3.5 x 12mm		20PCS
O	Panhead Screw M4 x 30mm		20PCS
R	Bed Bracket L/R		4PCS

Step 16 : Connect the Side Rail (30) to the Headboard and Footboard with JCBB M8 x 20mm (G).

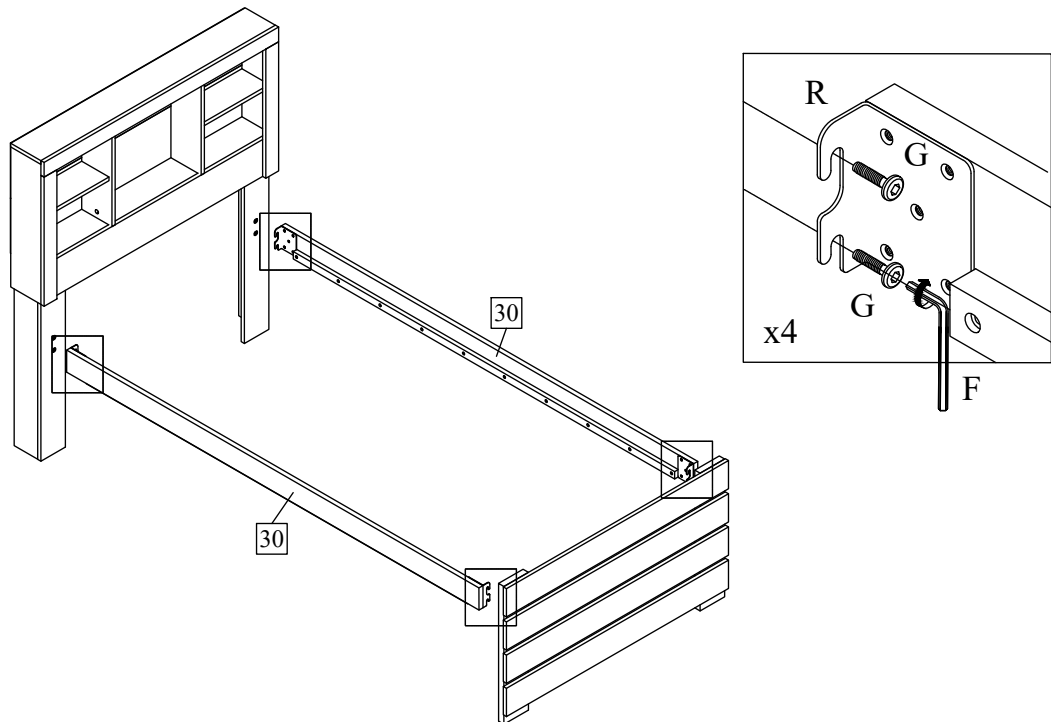



G	JCBB M8 x 20mm		8PCS
---	----------------	---	------

ASSEMBLY INSTRUCTIONS
Item No : WF316099 / WF316105
Description : TWIN BED

Thank you for purchasing this quality product. Be sure to check all packing material carefully for small part that may have come loose inside carton during shipment.

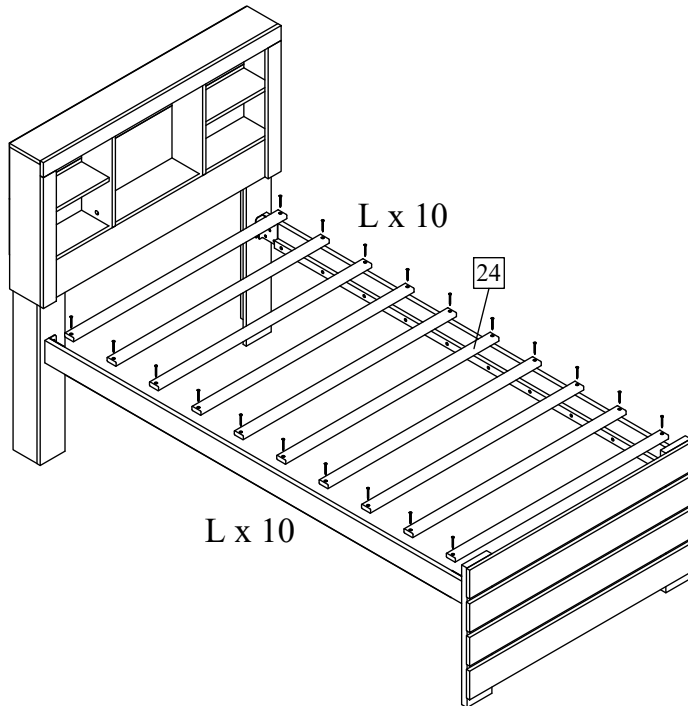
Step 17 : Connect the Bed Slat (Full) (24) to the bed with CSK Screw M4 x 32mm (L).



L	CSK Screw M4 x 32mm		20PCS
---	---------------------	---	-------

Step 18 : Connect the Drawer Slide Support Short - L (19), Side Support Cube (21) and Roller Support Cube (23) to the Trundle - Side Panel L (27) with Panhead Screw M4 x 25mm (N).

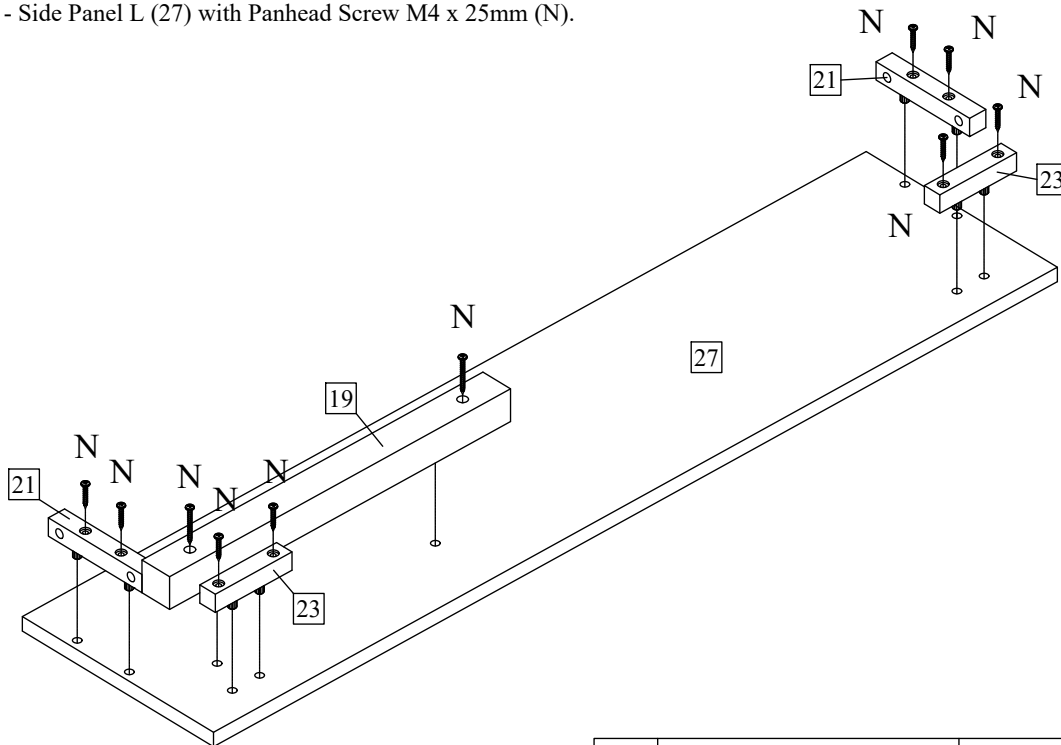



N	Panhead Screw M4 x 25mm		10PCS
---	-------------------------	---	-------

ASSEMBLY INSTRUCTIONS
Item No : WF316099 / WF316105
Description : TWIN BED

Thank you for purchasing this quality product. Be sure to check all packing material carefully for small part that may have come loose inside carton during shipment.

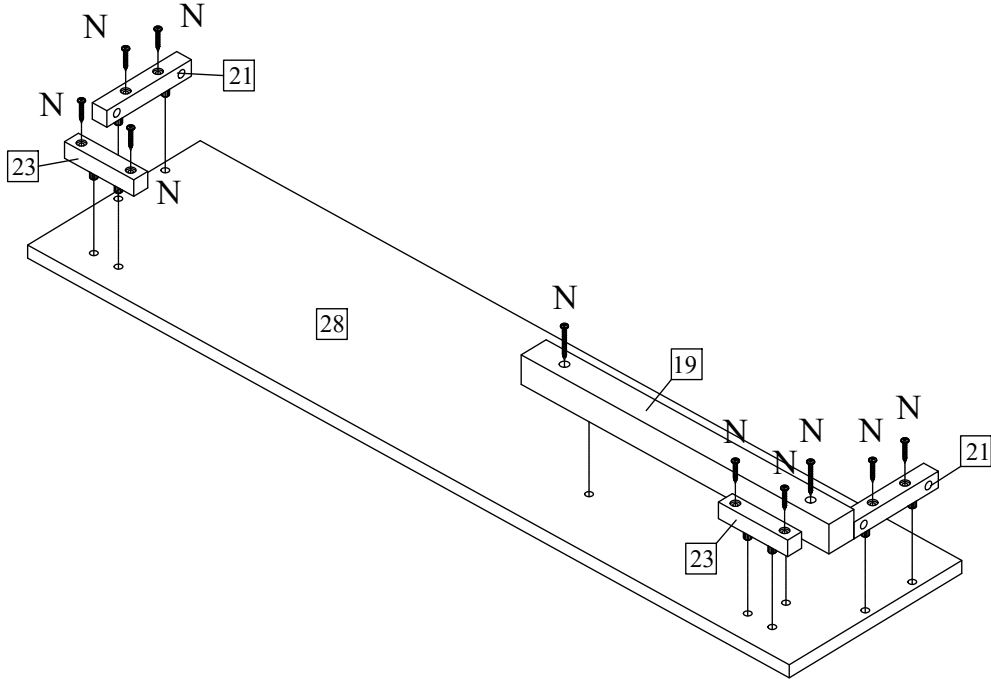
Step 19 : Connect the Drawer Slide Support Short - R (20), Side Support Cube (21) and Roller Support Cube (23) to the Trundle - Side Panel R (28) with Panhead Screw M4 x 25mm (N).



N	Panhead Screw M4 x 25mm		10PCS
---	-------------------------	---	-------

Step 20 : Attach the Drawer Slide 12" (S1) and Roller (T) to the Trundle - Side Panel L (27) with CSK Screw M3.5 x 12mm (K).

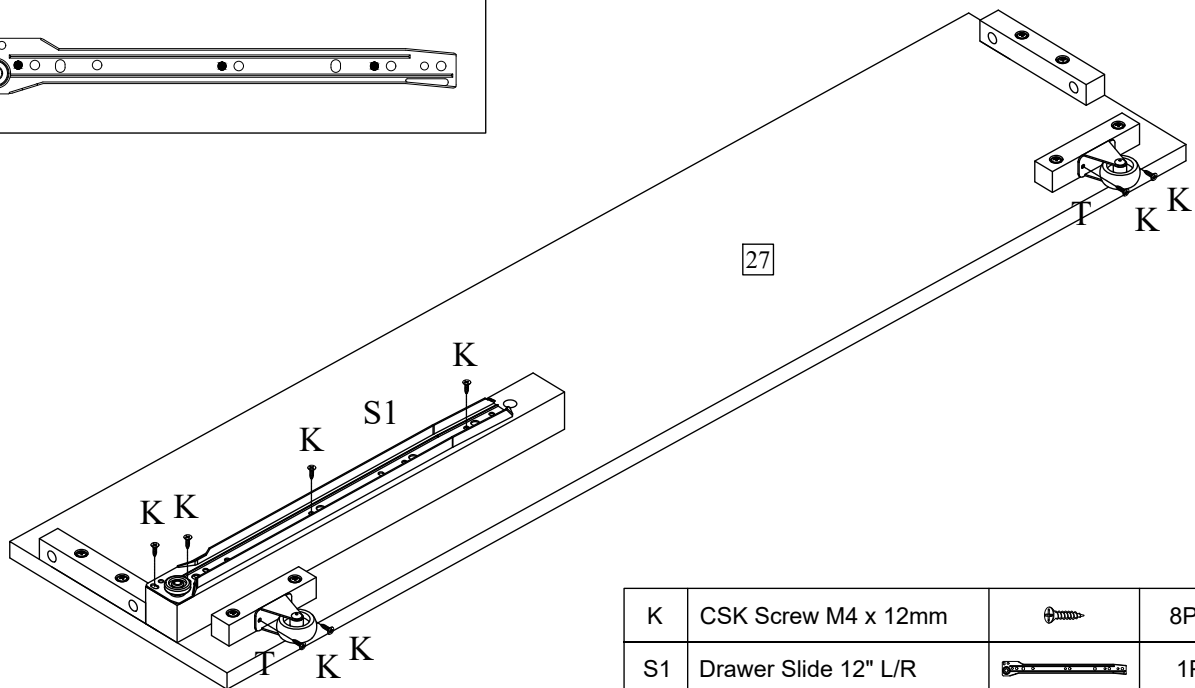
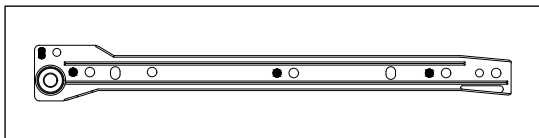





K	CSK Screw M4 x 12mm		8PCS
S1	Drawer Slide 12" L/R		1PC
T	Roller		2PCS

ASSEMBLY INSTRUCTIONS
Item No : WF316099 / WF316105
Description : TWIN BED

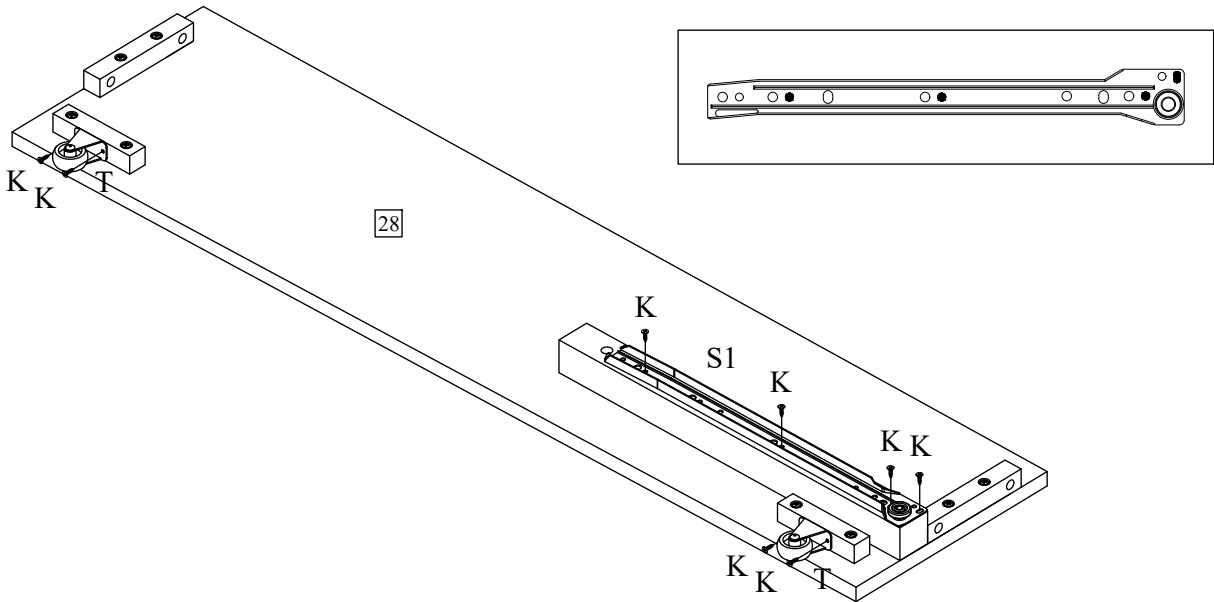
Thank you for purchasing this quality product. Be sure to check all packing material carefully for small part that may have come loose inside carton during shipment.

Step 21 : Attach the Drawer Slide 12" (S1) and Roller (T) to the Trundle - Side Panel L (27) with CSK Screw M3.5 x 12mm (K).



K	CSK Screw M4 x 12mm		8PCS
S1	Drawer Slide 12" L/R		1PC
T	Roller		2PCS

Step 22 : Connect the Slat Support - B (32) to the Trundle - Back Panel (29) with Panhead Screw M4 x 25mm (N).

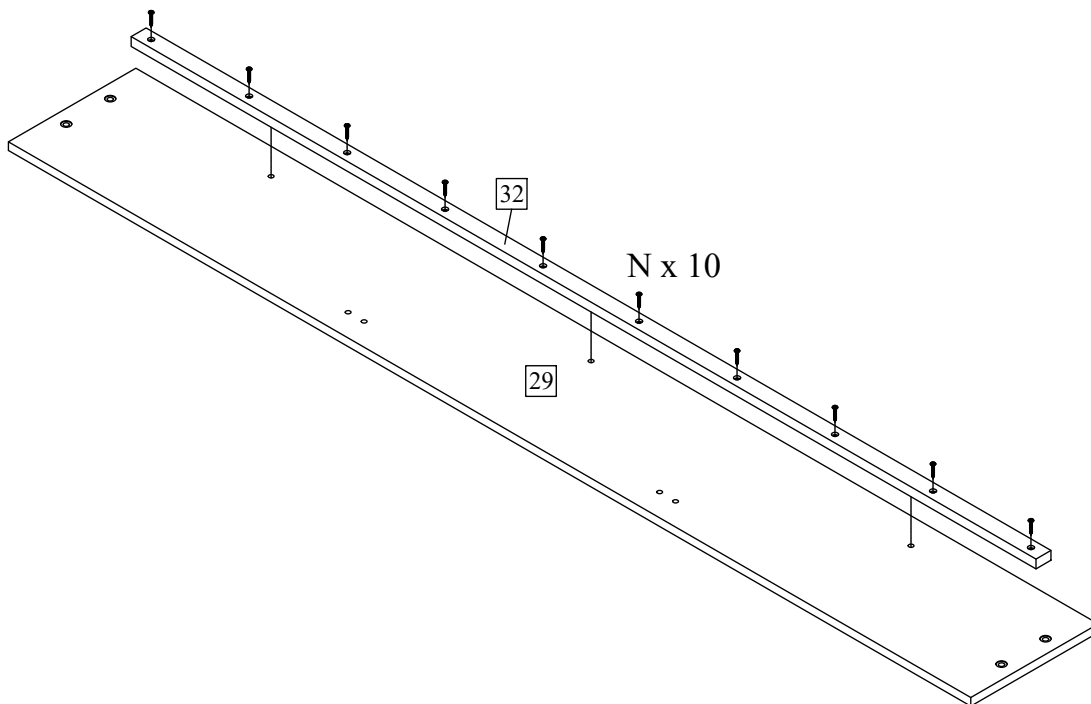

N	Panhead Screw M4x 25mm		10PCS
---	------------------------	---	-------

ASSEMBLY INSTRUCTIONS
Item No : WF316099 / WF316105
Description : TWIN BED

Thank you for purchasing this quality product. Be sure to check all packing material carefully for small part that may have come loose inside carton during shipment.

Step 23 : Attach the Drawer Slide 12" (S1) to the Drawer Slide Support Long (18) with CSK Screw M3.5 x 12mm (K).

Assembly x 2

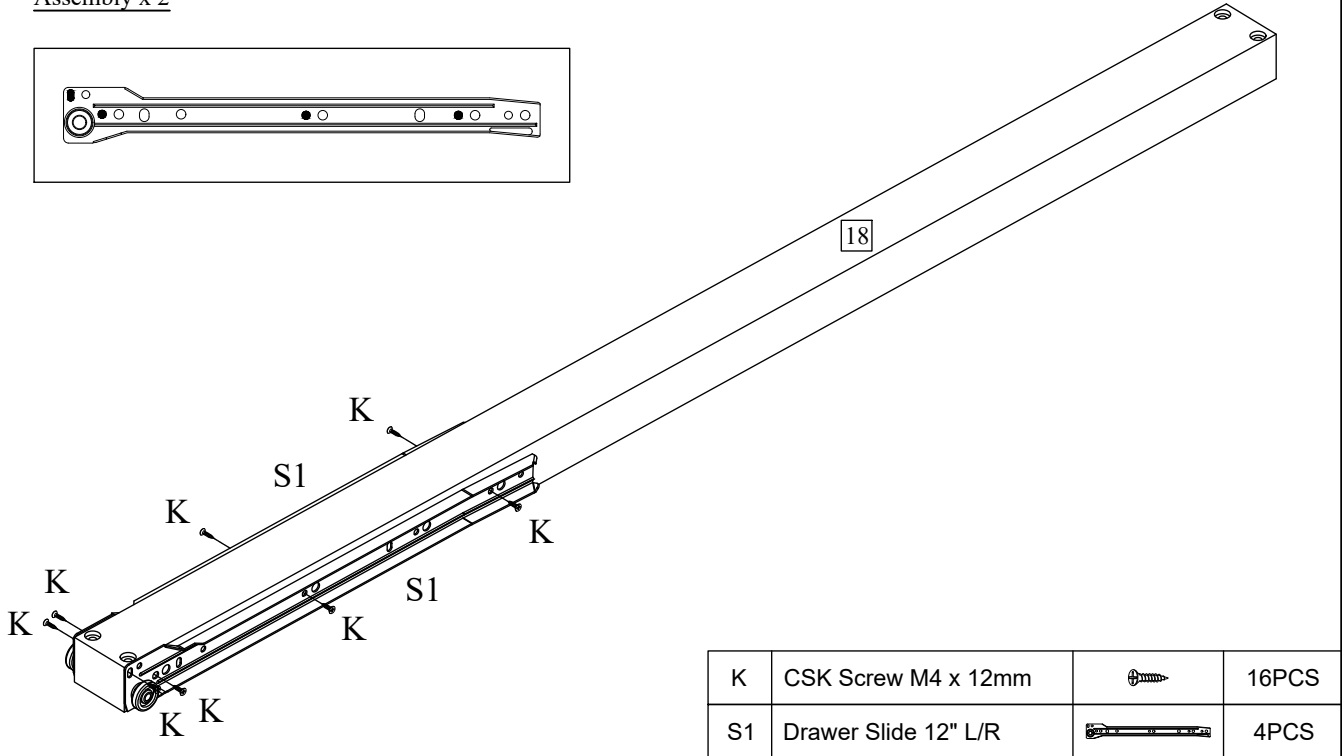

Step 24 : Connect the Drawer Slide Support Cube (21) to the Drawer Slide Support Long (18) with Panhead Screw M4 x 30mm (O).

Assembly x 2

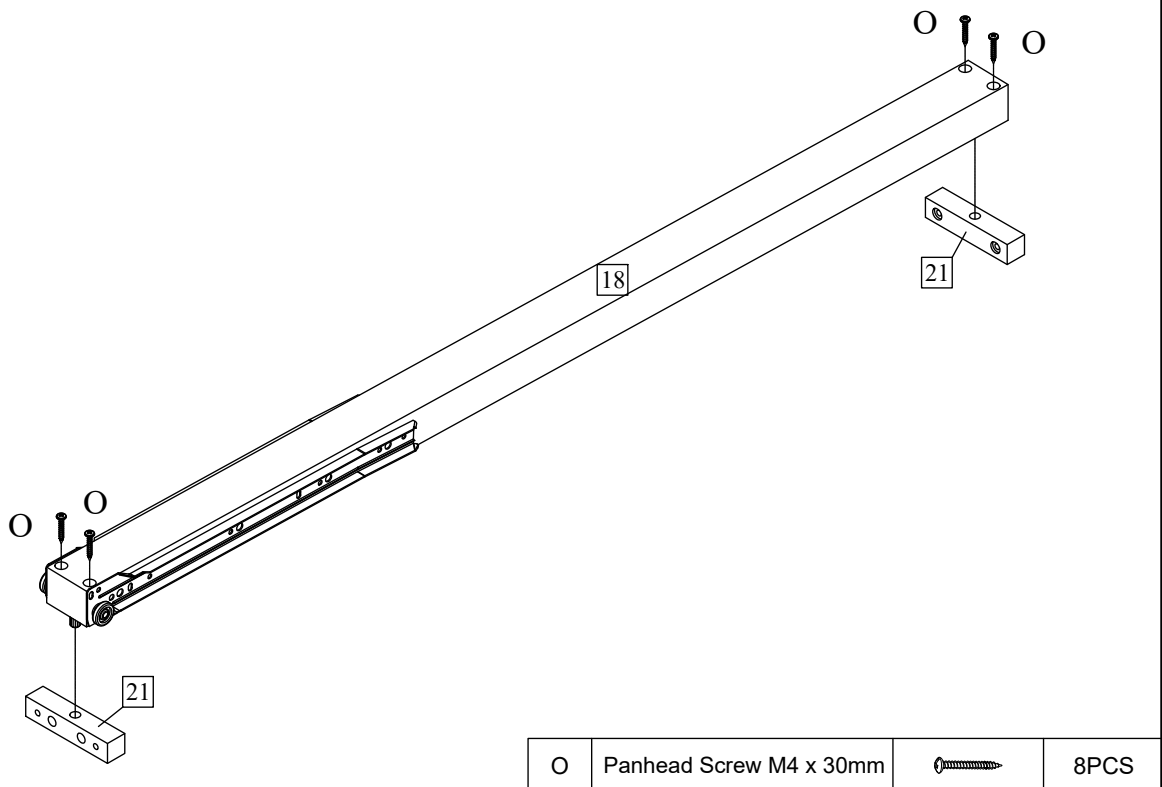

ASSEMBLY INSTRUCTIONS
Item No : WF316099 / WF316105
Description : TWIN BED

Thank you for purchasing this quality product. Be sure to check all packing material carefully for small part that may have come loose inside carton during shipment.



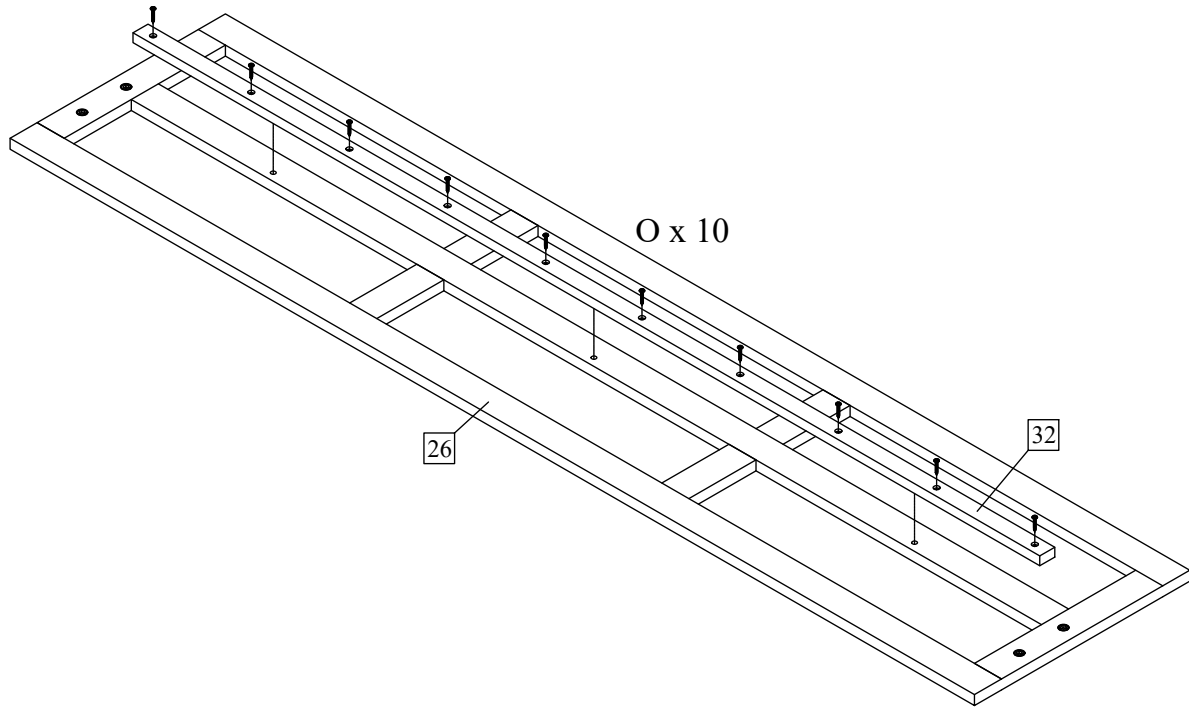

Step 25 : Attach the Slat Support - B (32) to the Trundle - Front Frame (26) with Panhead Screw M4 x 30mm (O).

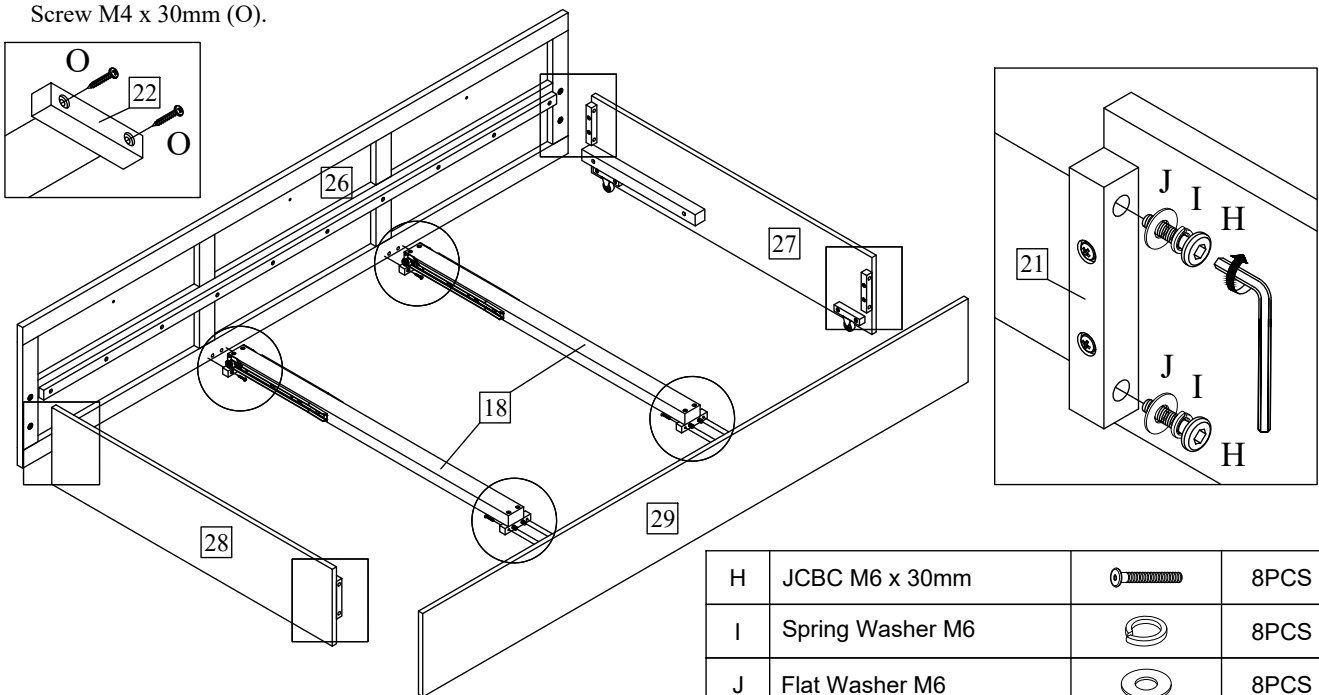

O	Panhead Screw M4 x 30mm		10PCS
---	-------------------------	---	-------

Step 26 : Connect the Trundle - Front Frame (26) and Trundle - Back Panel (29) to the Drawer Slide Support Long (18), Trundle - Side Panel L (27) and Trundle - Side Panel R (28) with JCBC M6 x 30mm (H), Spring Washer (I), Flat Washer (J) and Panhead Screw M4 x 30mm (O).



H	JCBC M6 x 30mm		8PCS
I	Spring Washer M6		8PCS
J	Flat Washer M6		8PCS
O	Panhead Screw M4 x 30mm		8PCS

ASSEMBLY INSTRUCTIONS

Item No : WF316099 / WF316105

Description : TWIN BED

Thank you for purchasing this quality product. Be sure to check all packing material carefully for small part that may have come loose inside carton during shipment.

Step 27 : Drawer assembly.

First connect Drawer Back (37) to Drawer Side - L (35) and Drawer Side - R (36) with CSK Screw M4 x 32MM (L).

Slot the Drawer Bottom Support (39) into Drawer Back (37). Next, slot in the Drawer Bottom (38).

Then, install the Handle (Q) with Handle Screw (P) onto Drawer Front (34). Attach the Drawer Front (34) to the drawer box and lock the Minifix Cam (C).

Finally, install Drawer Slide (S2) onto the drawer box using CSK Screw M3.5 x 12MM (K).

K x 3

Drawer assembly x 3

C	Minifix Cam (Ø12mm)		18PCS
K	CSK Screw M3.5 x 12mm		18PCS
L	CSK Screw M4 x 32mm		12PCS
P	Handle Screw		3PCS
Q	Handle		3PCS
S	Drawer Slide 12" S2 (L/R)		3SETS

Lock Minifix Cam clockwise

Step 28 : Attach Handle (Q) to the Trundle - Front Frame (26) with Handle Screw M4 x 10mm (P).

Then, Insert the drawer box.

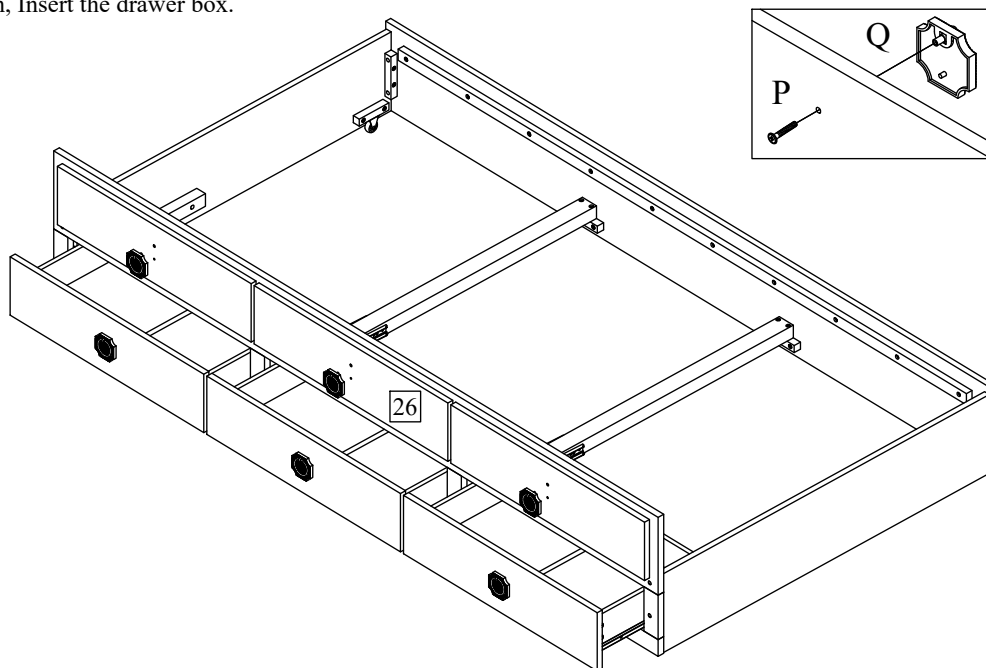



P	Handle Screw		3PCS
Q	Handle		3PCS

ASSEMBLY INSTRUCTIONS
Item No : WF316099 / WF316105
Description : TWIN BED

Thank you for purchasing this quality product. Be sure to check all packing material carefully for small part that may have come loose inside carton during shipment.

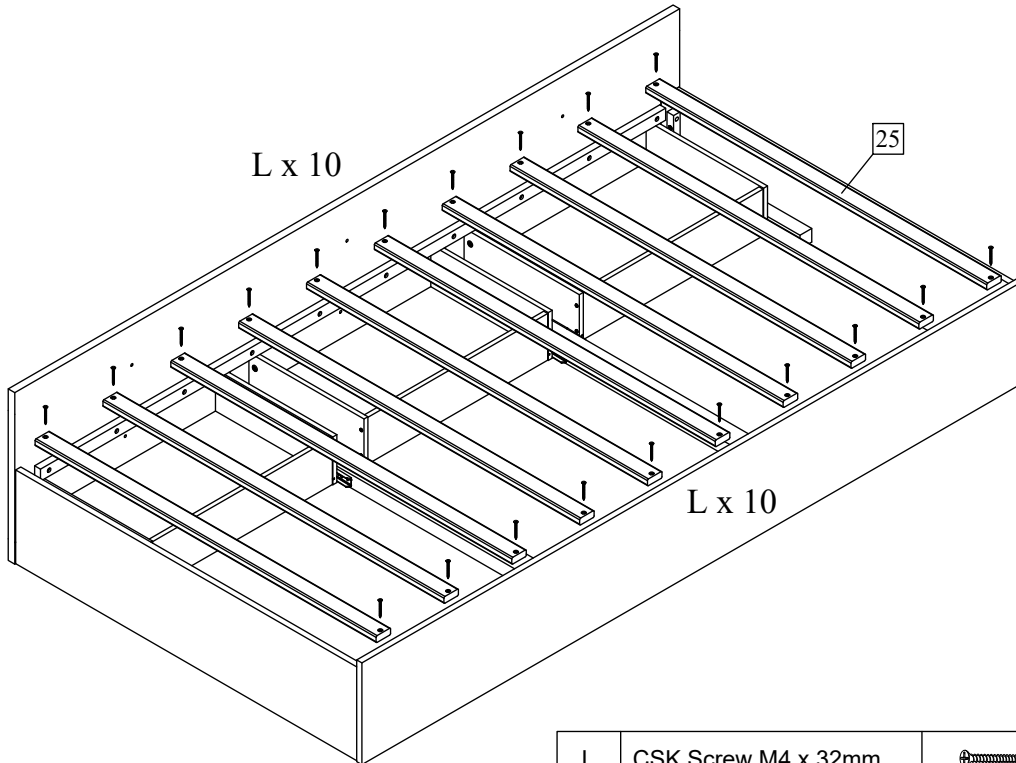
Step 29 : Connect the Trundle Bed Slat (Twin) (25) to the trundle bed with CSK Screw M4 x 32mm (L).



L	CSK Screw M4 x 32mm		20PCS
---	---------------------	---	-------

Step 30 : Insert the trundle bed.

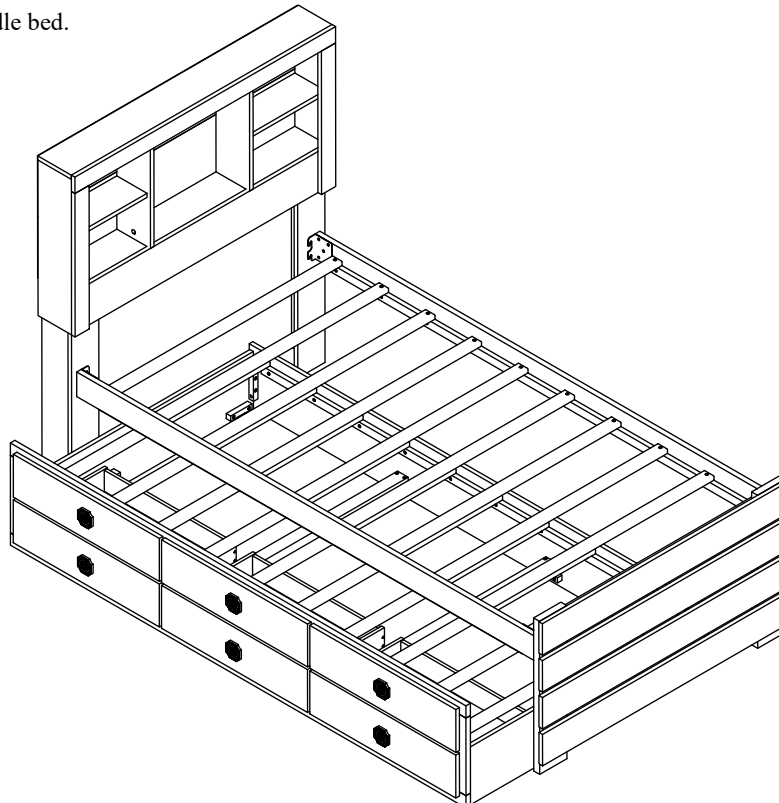

ASSEMBLY INSTRUCTIONS
Item No : WF316099 / WF316105
Description : TWIN BED

Thank you for purchasing this quality product. Be sure to check all packing material carefully for small part that may have come loose inside carton during shipment.

Completed assembly.

