

ASSEMBLY INSTRUCTION

N723P180218
N723P180221
N723P180222
N723P180223

Friendly Reminder:

- 1.This sofa is packed in 4 boxes. Please assemble it After all boxes are received.
- 2.As the cushions are all vacuum compressed,there will be some wrinkles. Please give your cushions up to 72 hours to reach its original size and the wrinkles will basically disappear.
- 3.Please do not open the compressed packags until your sofa frame is completely assembled.

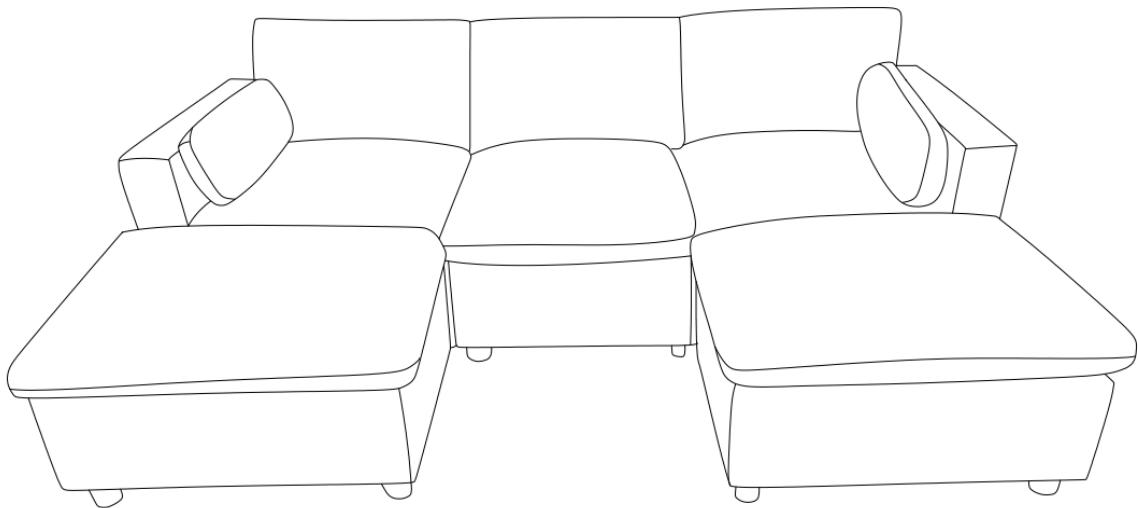









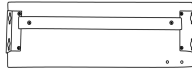

Return & Warranty policy:



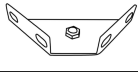
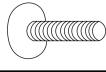
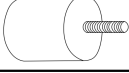

- We strive to offer the highest quality products,and we also try our best to satisfy each and every customer that orders from us with replacement parts or service as needed.
- If the item is damaged or defective, please take photos as evidence for replacements and refunds.
- Please do not return to store,contact the seller if you have any troubles with this product.

ASSEMBLY INSTRUCTION

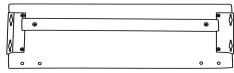

PARTS LIST N723P180221

NO	DESCRIPTION	SKETCH	QTY
AL	Left front baffle		1
AR	Right front baffle		1
B	Right baffle		1
C	Left baffle		1
D	Left backrest		1
E	Right backrest		1
F	Seat cushion		2
Y	Wood strip		2
G	Hinge		2
H	Leg iron		2
I	Screw		12
J	Leg		8
S	Armrest cushion		2
X	Gasket		8





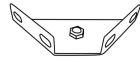
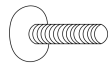
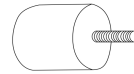



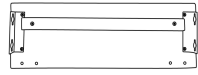

PARTS LIST N723P180222

NO	DESCRIPTION	SKETCH	QTY
K	Ottoman front baffle		4
L	Ottoman Lateral baffle		4
M	Ottoman cushion		2
N	Backrest cushion		2
Z	Ottoman Wood strip		2

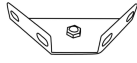
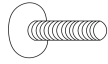
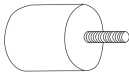

ASSEMBLY INSTRUCTION

H	Leg iron		8
I	Screw		32
J	Leg		8
T	Simple screwdriver		1
X	Gasket		8

PARTS LIST N723P180223

NO	DESCRIPTION	SKETCH	QTY
A	Middle front baffle		1
C	Left baffle		1
B	Right baffle		1
O	Middle backrest		1
F	Seat cushion		1
N	Backrest cushion		1
Y	Wood strip		1
G	Hinge		2
H	Leg iron		2
I	Screw		12
J	Leg		4
X	Gasket		4

PARTS LIST N723P180218

NO	DESCRIPTION	SKETCH	QTY
P	Left armrest		1
Q	Right armrest		1

ASSEMBLY INSTRUCTION

Unpacking and removal of items from packages

N723P180221

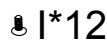
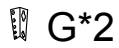
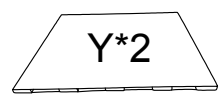
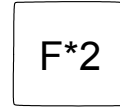
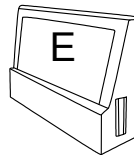
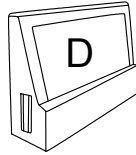
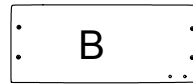
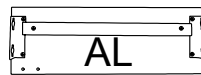
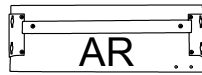
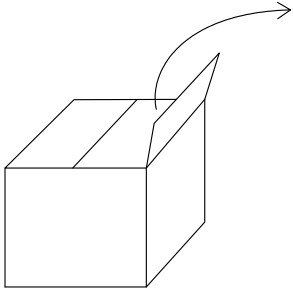

N723P180222

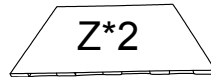
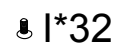
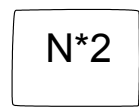
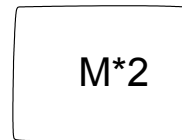
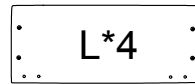
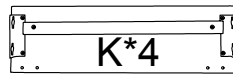
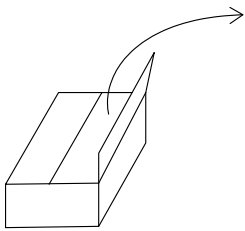

N723P180223

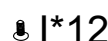
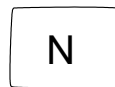
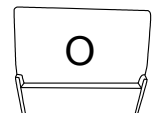
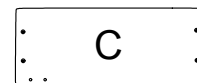
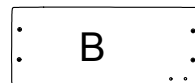
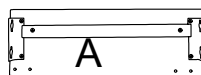
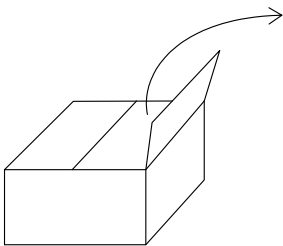

N723P180218

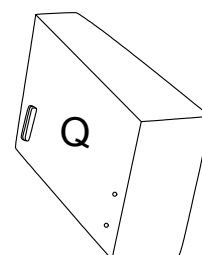
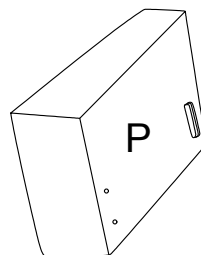
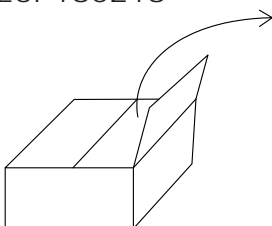

ASSEMBLY INSTRUCTION

All parts and hardwares

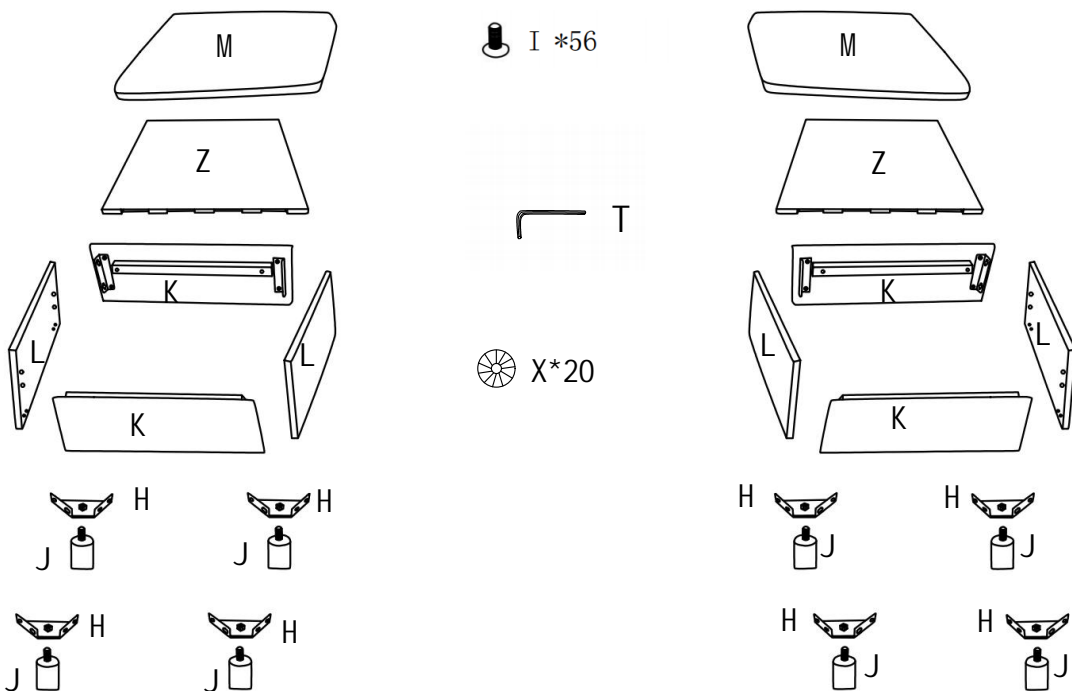
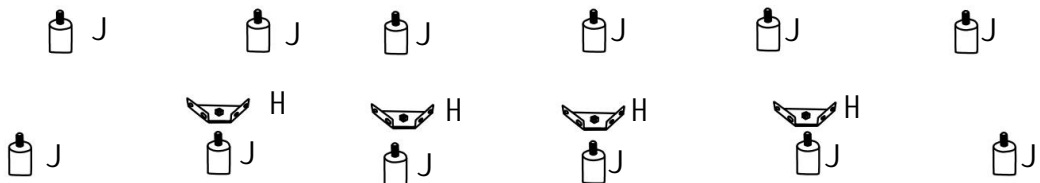
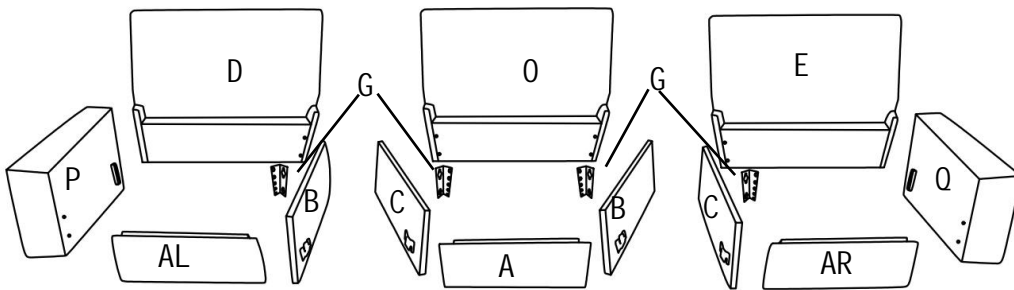
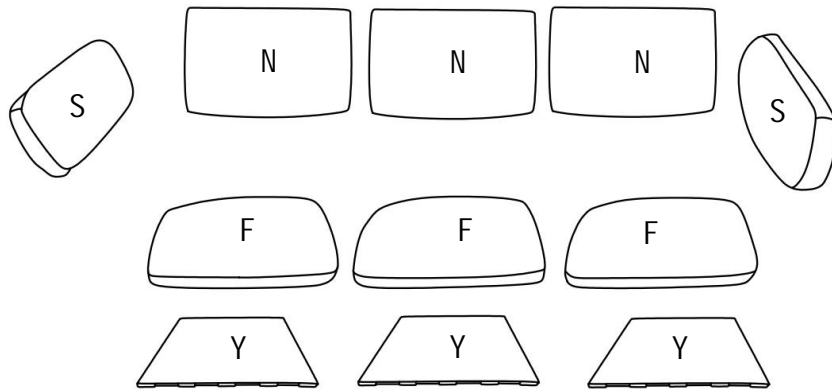





DIAGRAM 1

Connect Left armrest(Part P) and Left backrest(Part D) with the insert. Hang Hinge (Hardware G) on the screws of Right baffle(Part B), connect Left backrest(Part D) and Right baffle(Part B) with Screws(Hardware I), and tighten the screws with Simple screwdriver(Hardware T). Hang Left front baffle(Part AL) on the screws of Left armrest (Part P) and Right baffle(Part B) respectively, tighten the screws, and the left seat frame is connected.

T		1PC
G		1PC
I		2PCS

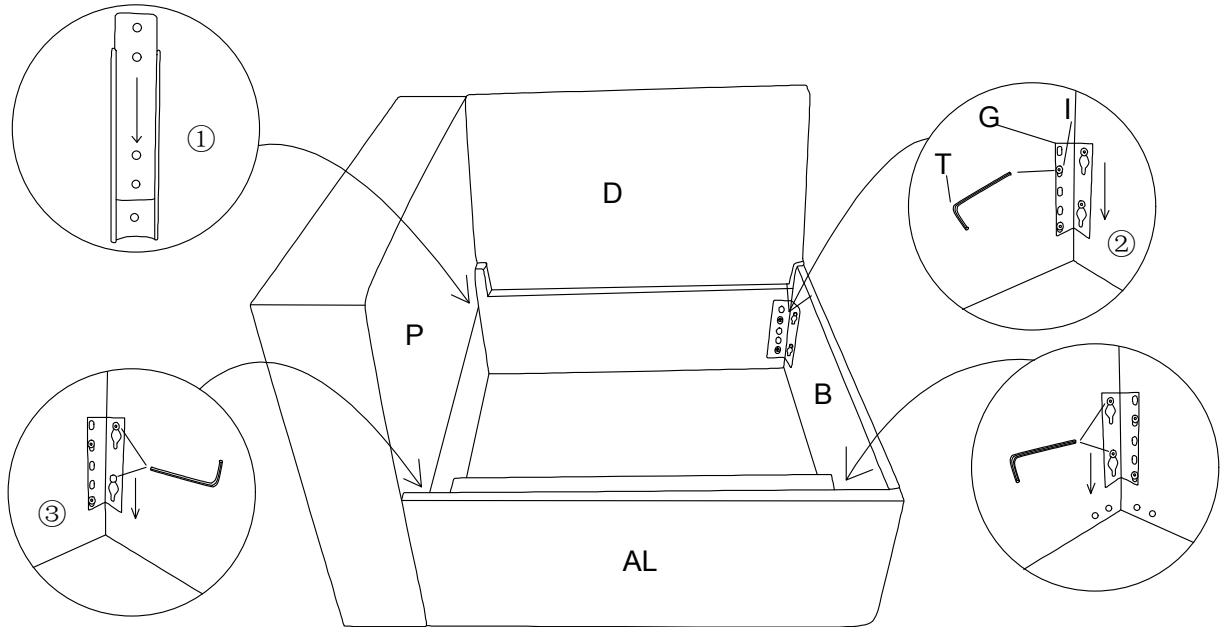







DIAGRAM 2

Use Screws(Hardware I) to fix Leg iron (Hardware H) at the connection between Left front baffle(Part AL) and Right baffle(Part B). Put Gaskets (Hardware X) on Legs (Hardware J) and install Legs(Hardware J) on the bottom of the left seat frame.

H		1PC
J		4PCS
X		4PCS
I		4PCS
T		1PC

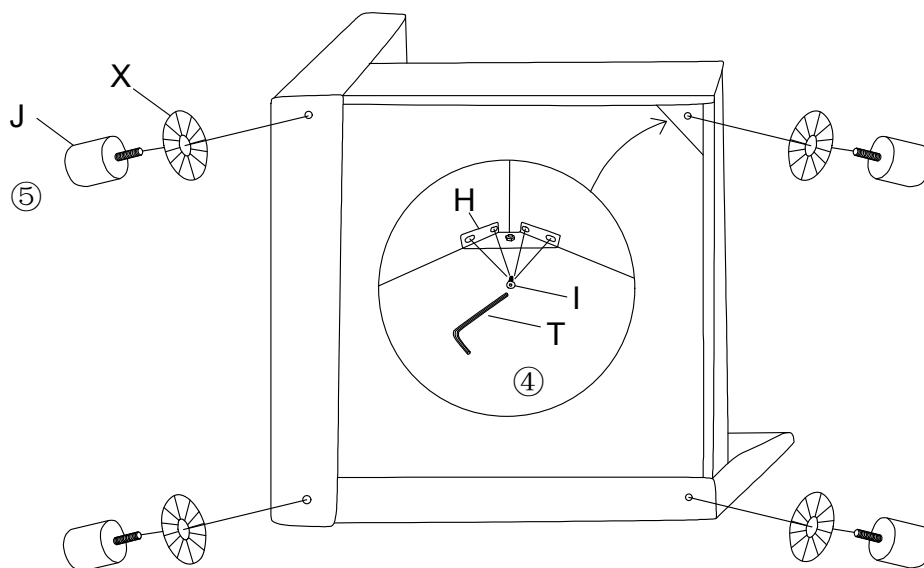





DIAGRAM 3

T		1PC
G		2PCS
I		4PCS

Hang Hinges(Hardware G) on the screws of Left baffle(Part C) and Right baffle(Part B), connect Right baffle(Part B) and Middle backrest(Part O) , Left baffle(Part C) and Middle backrest(Part O) with Screws(Hardware I) , and tighten the screws with Simplex crewdriver (Hardware T). Hang Middle front baffle(Part A) on the screws of Left baffle(Part C) and Right baffle(Part B) respectively, tighten the screws, and the middle seat frame is connected .

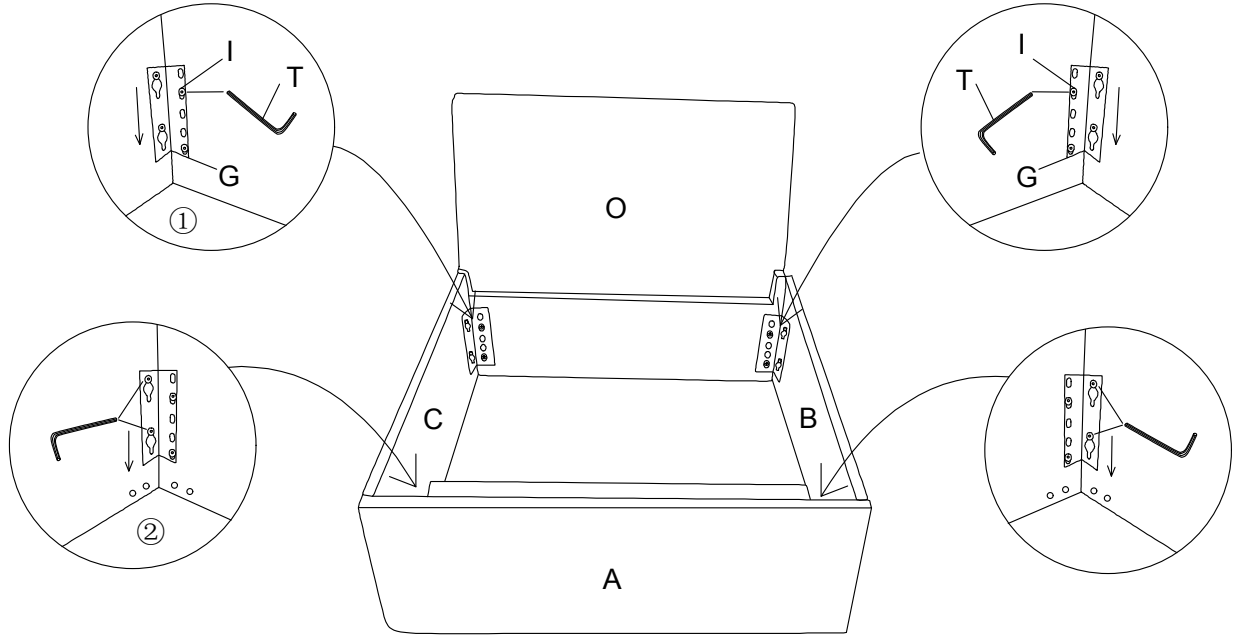







DIAGRAM 4

H		2PCS
J		4PCS
X		4PCS
I		8PCS
T		1PC

Use Screws(Hardware I) to fix Leg irons(Hardware H) at the connection between Left baffle(Part C) and Middle front baffle(Part A) , Right baffle(Part B) and Middle front baffle (Part A). Put Gaskets(Hardware X) on Legs(Hardware J) and install Legs (Hardware J) on the bottom of the middle seat frame.

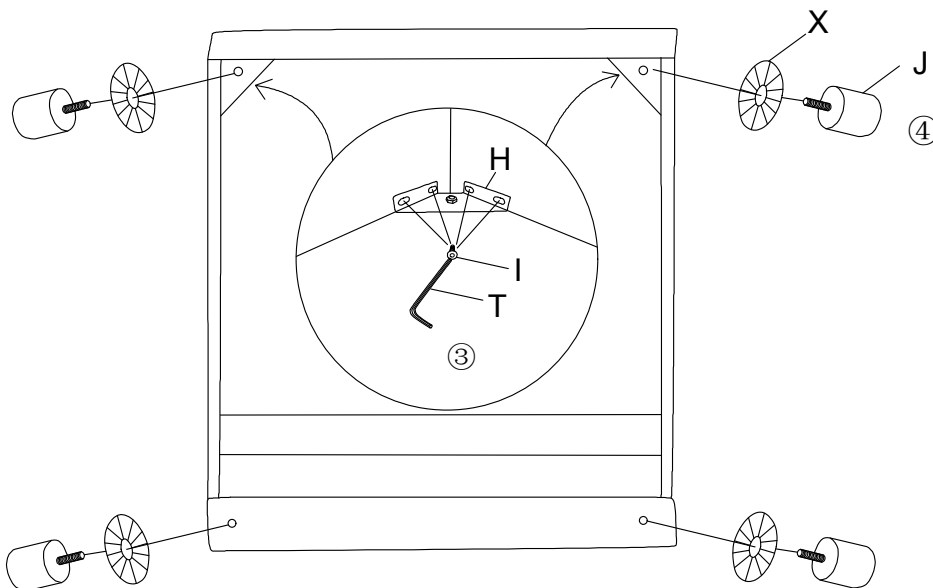





DIAGRAM 5

Connect Right armrest(Part Q) and Right backrest(Part E) with the insert. Hang Hinge (Hardware G) on the screws of Left baffle(Part C), connect Right backrest(Part E) and Left baffle(Part C) with Screws(Hardware I), and tighten the screws with Simple screwdriver(Hardware T). Hang Right front baffle(Part AR) on the screws of Right armrest (Part Q) and Left baffle(Part C) respectively, tighten the screws, and the Right seat frame is connected.

T		1PC
G		1PC
I		2PCS

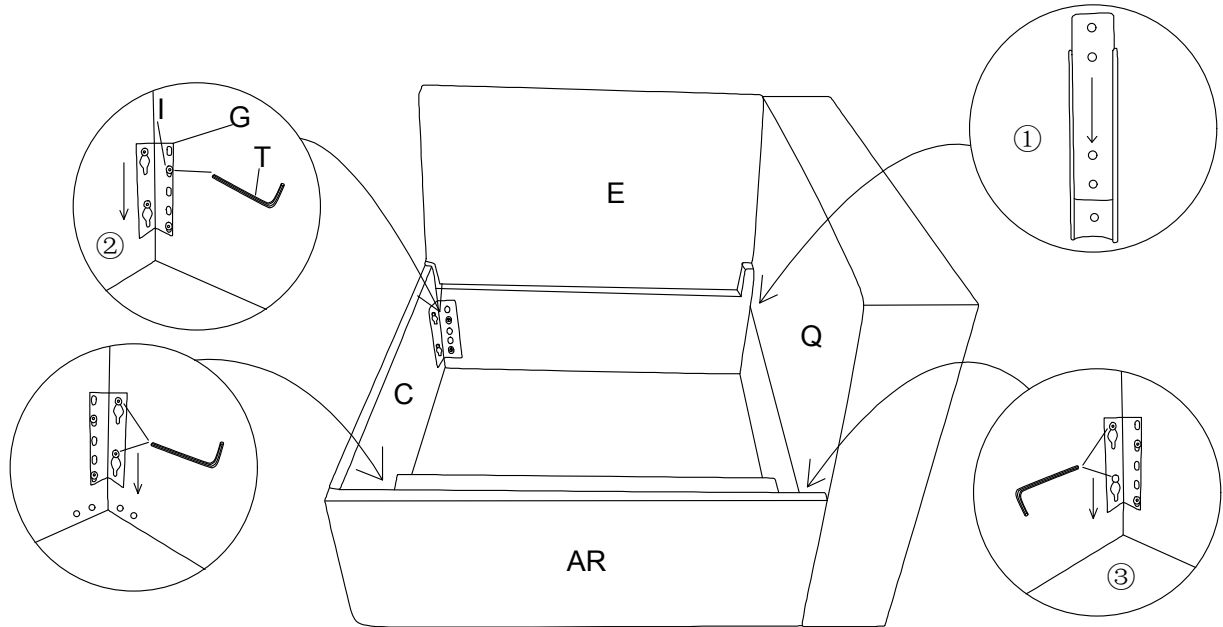







DIAGRAM 6

Use Screws(Hardware I) to fix Leg iron (Hardware H) at the connection between Right front baffle(Part AR) and Left baffle(Part C). Put Gaskets(Hardware X) on Legs (Hardware J) and install Legs(Hardware J) on the bottom of the Right seat frame.

H		1PC
J		4PCS
X		4PCS
I		4PCS
T		1PC

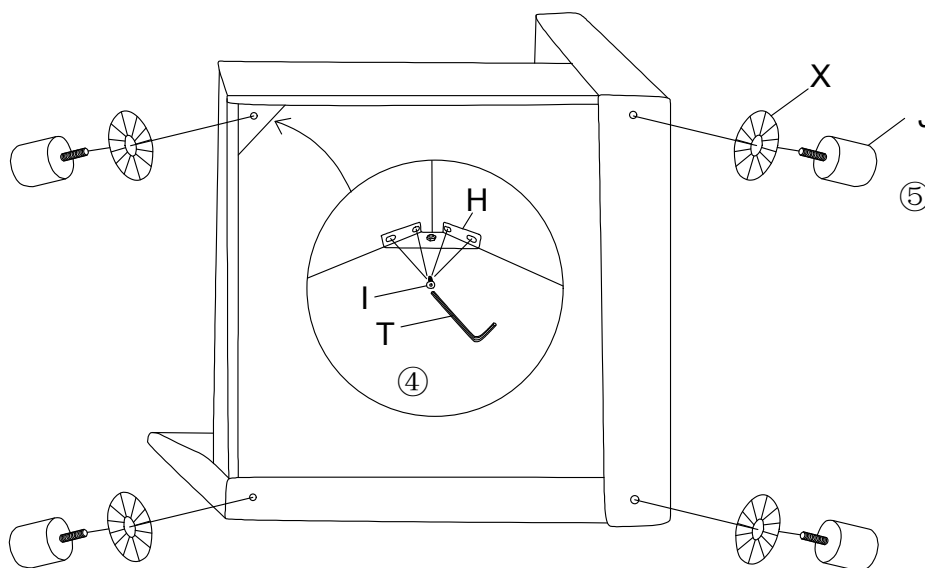

DIAGRAM 7

T		1PC
---	---	-----

Hang Ottoman front baffles(Part K) on the screws of Ottoman Lateral baffles(Part L), tighten the screws, and the ottoman seat frames are connected.

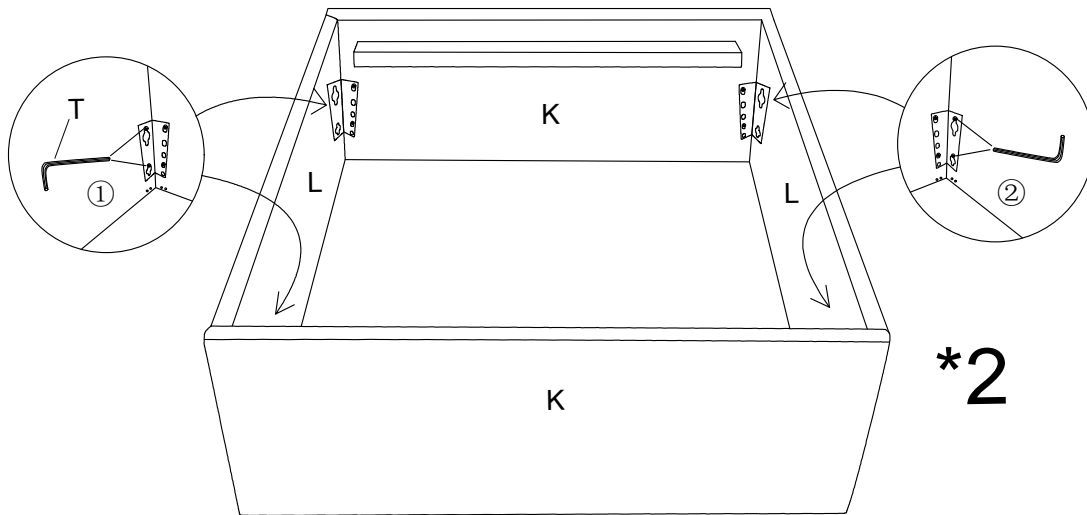







DIAGRAM 8

H		8PCS
J		8PCS
X		8PCS
I		32PCS
T		1PC

Use Screws(Hardware I) to fix Leg irons(Hardware H) at the connection between Ottoman front baffles(Part K) and Ottoman Lateral baffles(Part L). Put Gaskets(Hardware X) on Legs(Hardware J) and install Legs(Hardware J) on the bottom of the ottoman seat frames.

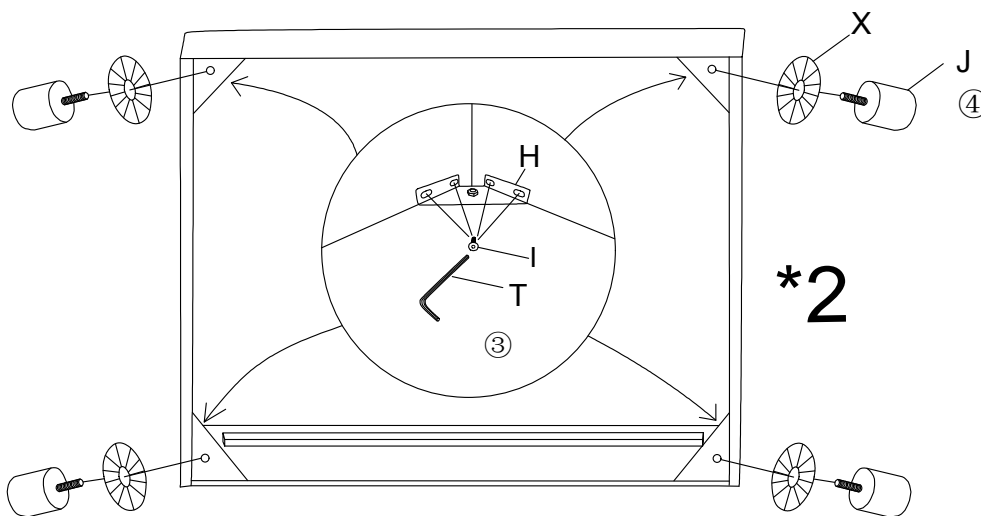

DIAGRAM 9

Fasten Wood strips(Part Y) to the sofa seat frame with Velcro.Put Seat cushions, Backrest cushions, Armrest cushions(Part F、N、S) on the sofa.

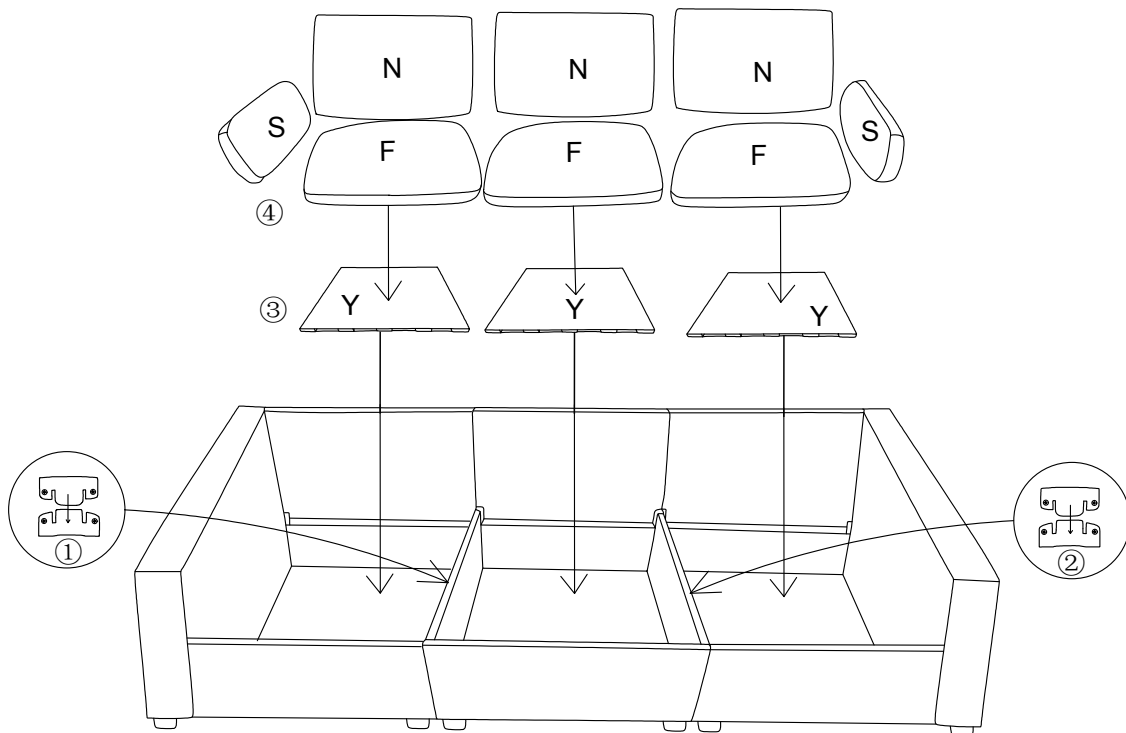
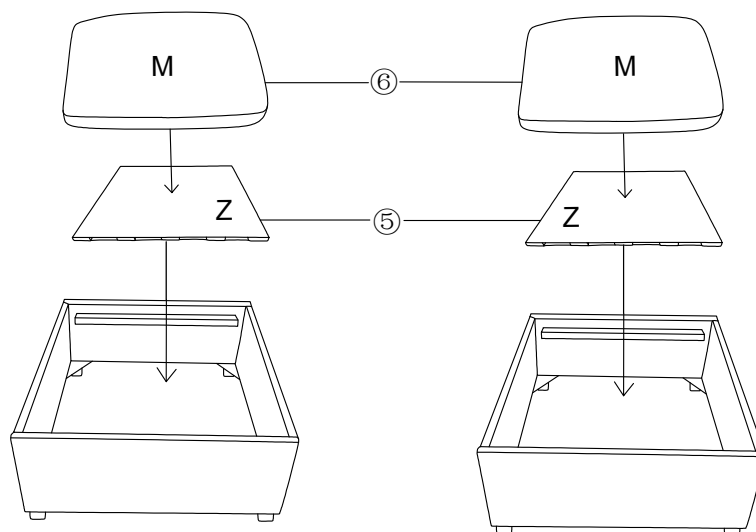

DIAGRAM 10

Fasten Ottoman Wood strips(Part Z) to the ottoman seat frames with Velcro.Put Ottoman cushions(Part M) on the ottoman.



DONE

