

# ASSEMBLY INSTRUCTION

---

N723P186135

N723P186137

## Friendly Reminder:

- 1.This sofa is packed in 2 boxes. Please assemble it After all boxes are received.
- 2.As the cushions are all vacuum compressed,there will be some wrinkles. Please give your cushions up to 72 hours to reach its original size and the wrinkles will basically disappear.
- 3.Please do not open the compressed packags until your sofa frame is completely assembled.

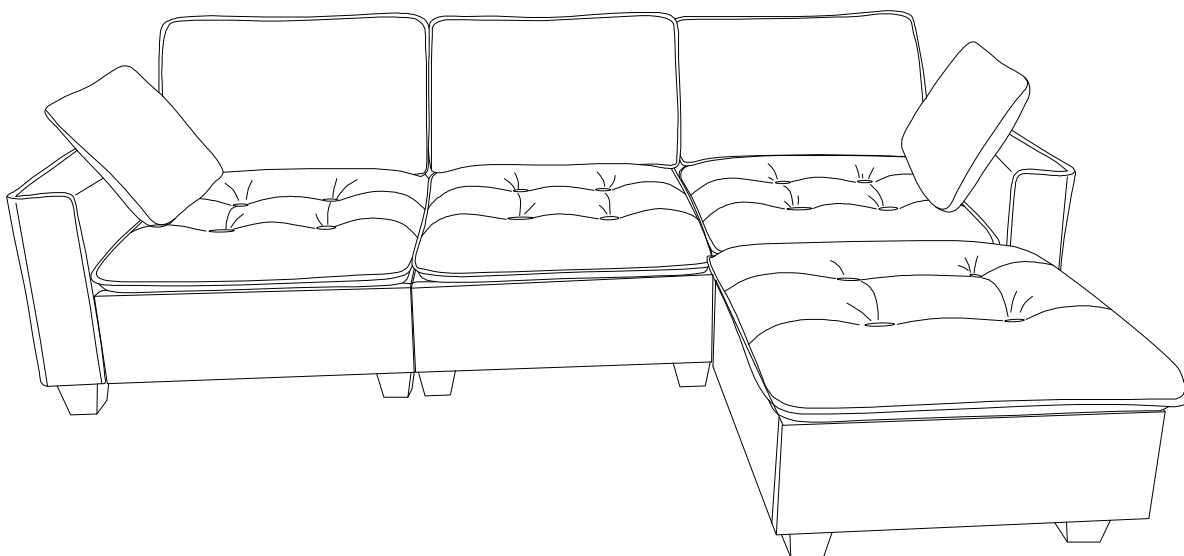







## Return & Warranty policy:

- We strive to offer the highest quality products,and we also try our best to satisfy each and every customer that orders from us with replacement parts or service as needed.
- If the item is damaged or defective, please take photos as evidence for replacements and refunds.
- Please do not return to store,contact the seller if you have any troubles with this product.

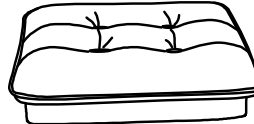



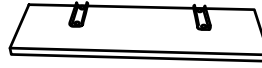

# ASSEMBLY INSTRUCTION

## PARTS LIST N723P186135

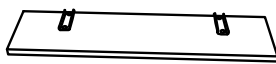
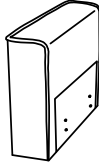
NO	DESCRIPTION	SKETCH	QTY
A	Seat frame		3
B	Long baffle		2
C	Seat cushion		3
H	Back cushion		3
I	Pillow		1
K	Ottoman cushion		1
P	Short baffle		2

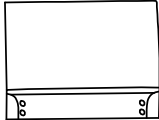
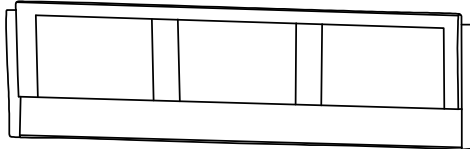

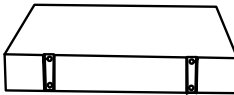

# ASSEMBLY INSTRUCTION

## PARTS LIST N723P186137

NO	DESCRIPTION	SKETCH	QTY
B	Long baffle		3
D	Left armrest		1
E	Right armrest		1
F	Back frame		3
G	Back cover		1
I	Pillow		1
J	Ottoman frame		1
O	Leg		16

# ASSEMBLY INSTRUCTION

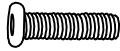
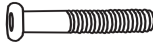



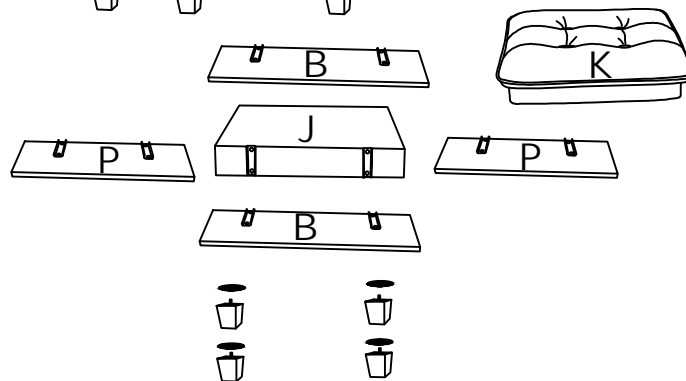
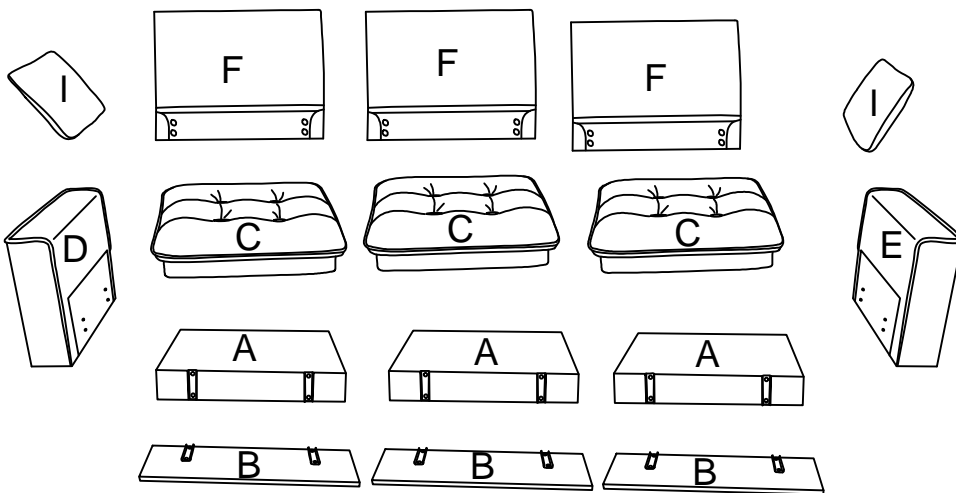
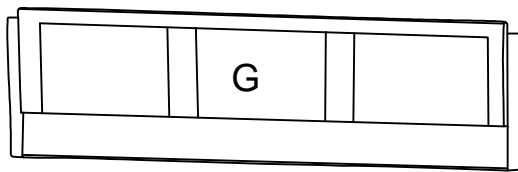
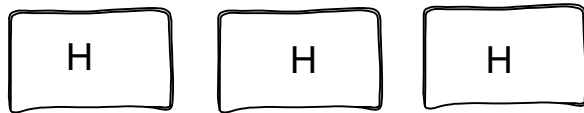

## HARDWARE N723P186137

NO	DESCRIPTION	SKETCH	QTY
1	Gasket		16
2	Washer		28
3	Screws 8X60		20
4	Screws 8X80		4
5	Butterfly nut		4
6	Wrench		1

# ASSEMBLY INSTRUCTION



All parts and hardwares.



1		Gasket	16
2		Washer	28
3		Screws 8X60	20
4		Screws 8X80	4
5		Butterfly nut	4
6		Wrench	1

**DIAGRAM 1** (Assemble the legs)

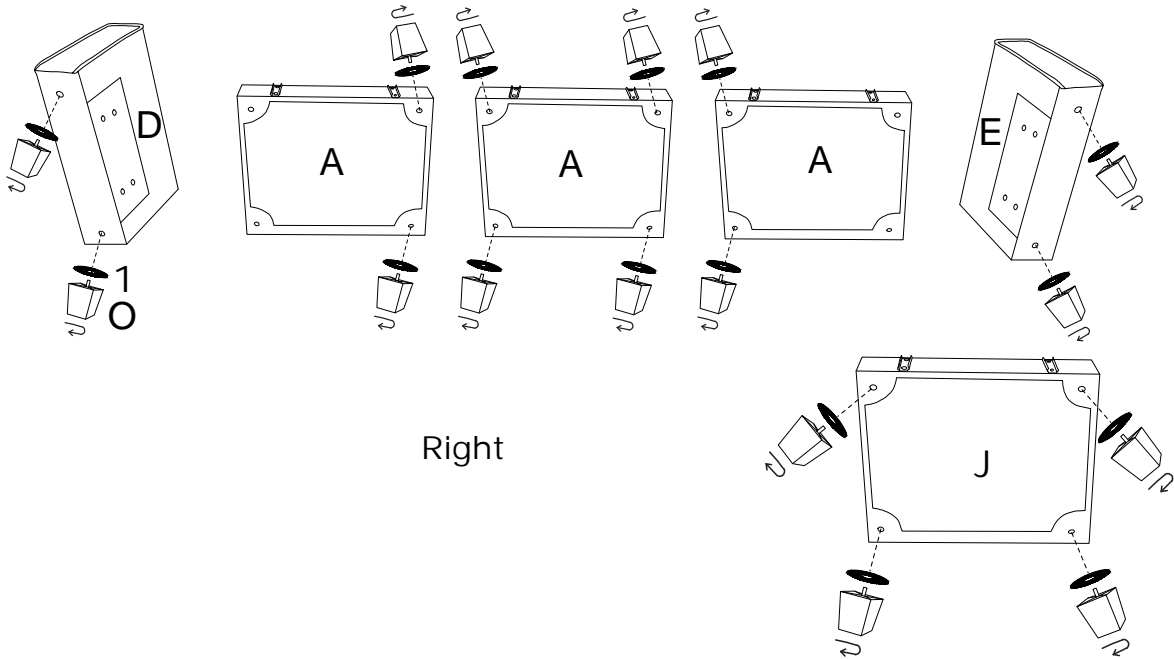

Assemble the Legs (Part O) on the Seat frames (Part A), Ottoman frame (Part J), Left armrest (Part D) and Right armrest (Part E) with the Gaskets (Hardware 1) .

1		16PCS
O		16PCS



**DIAGRAM 2** (Assemble the Armrest)



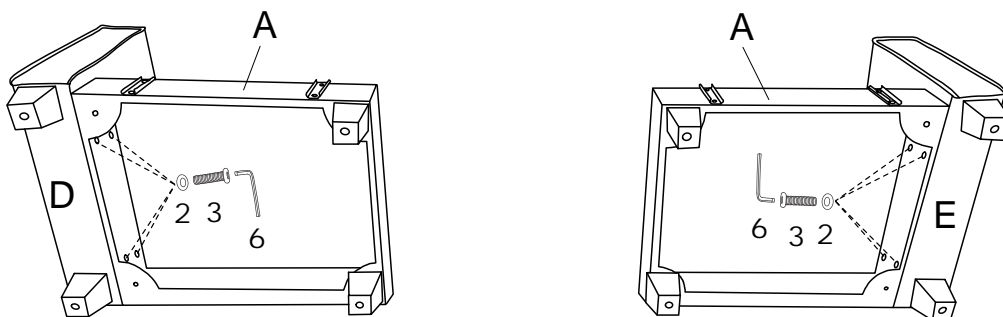

Assemble the Seat frames (Part A) and Left armrest (Part D) and Right armrest (Part E) with Washers (Hardware 2) and Screws (Hardware 3) by Wrench (Hardware 6) .

2		8PCS
3	 M8X60	8PCS



**DIAGRAM 3** (Assemble the Seat frames)

Assemble the Seat frames (Part A) with Washers (Hardware 2), Screws (Hardware 4) and Butterfly nuts (Hardware 5) by Wrench (Hardware 6).

2		8PCS
4	 M8X80	4PCS
5		4PCS
6		1PC

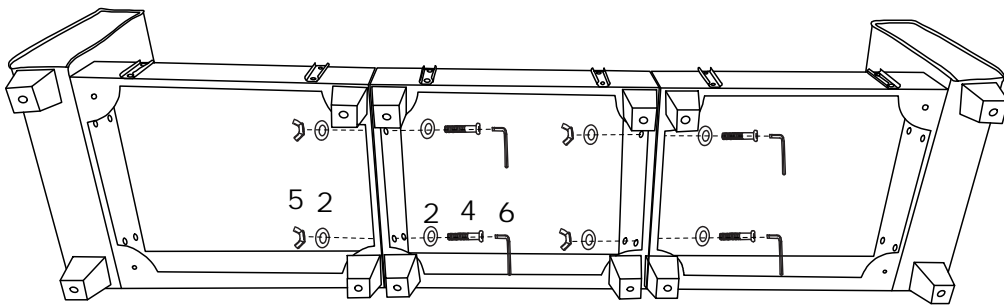

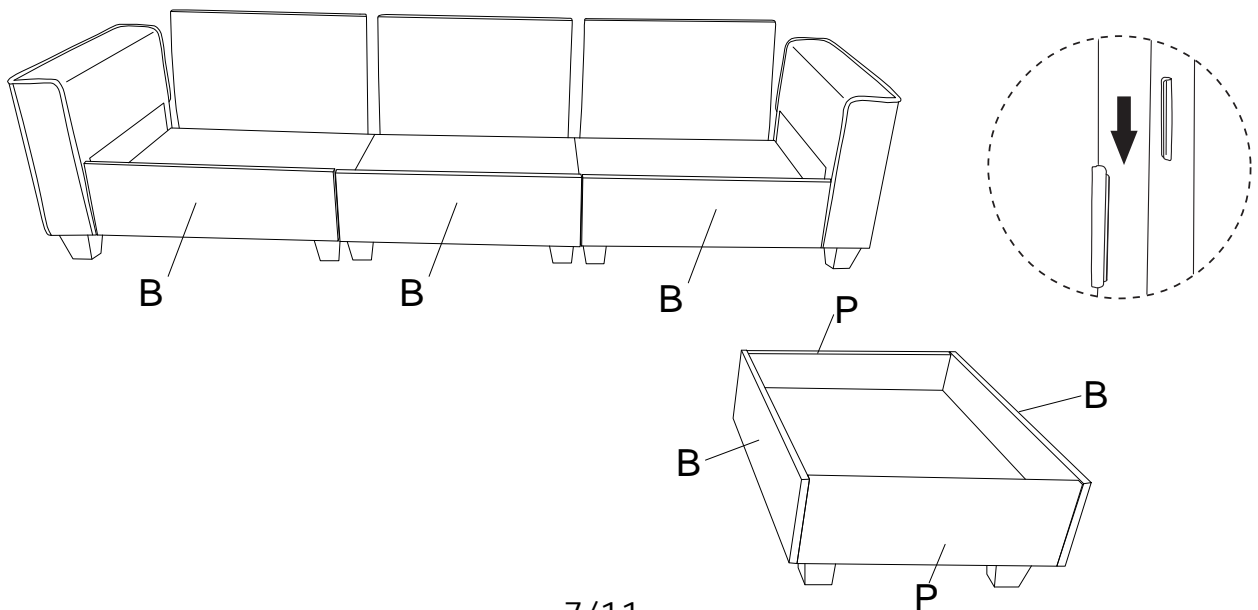

**DIAGRAM 4** (Assemble the Baffles)

Install the Long baffle (Part B) and Short baffle (Part P) onto the seat frames using the inserts.



**DIAGRAM 5** (Assemble the Back frame)

2		12PCS
3	 M8X60	12PCS

Place the washers (Hardware 2) and screws (Hardware 3) into the designated holes on the backrest, turn them to 70% by the wrench, and tighten all screws after it is fully installed.

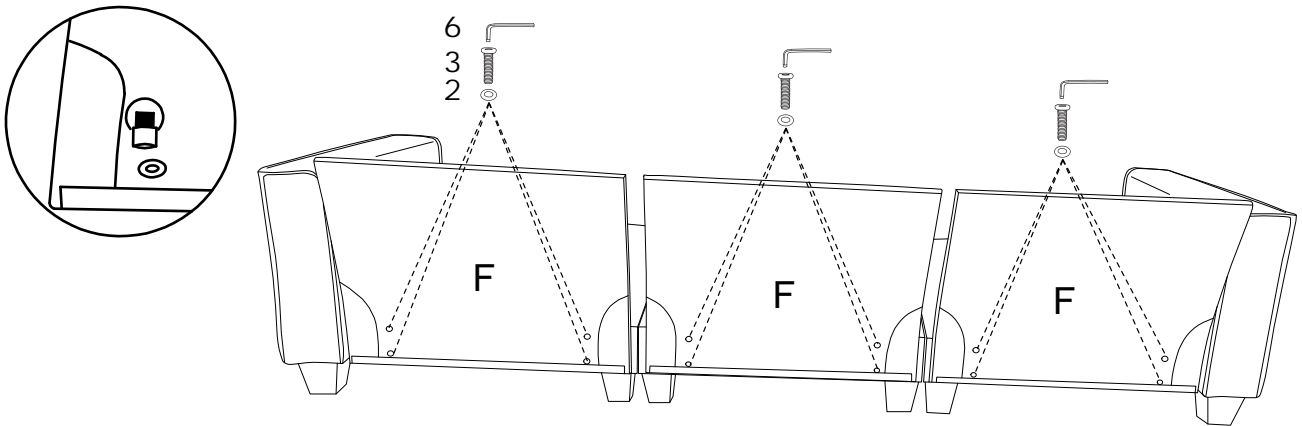

**DIAGRAM 6** (Put the Back cover on the Back frame)

Place the Back cover (Part G) on the Back frame.

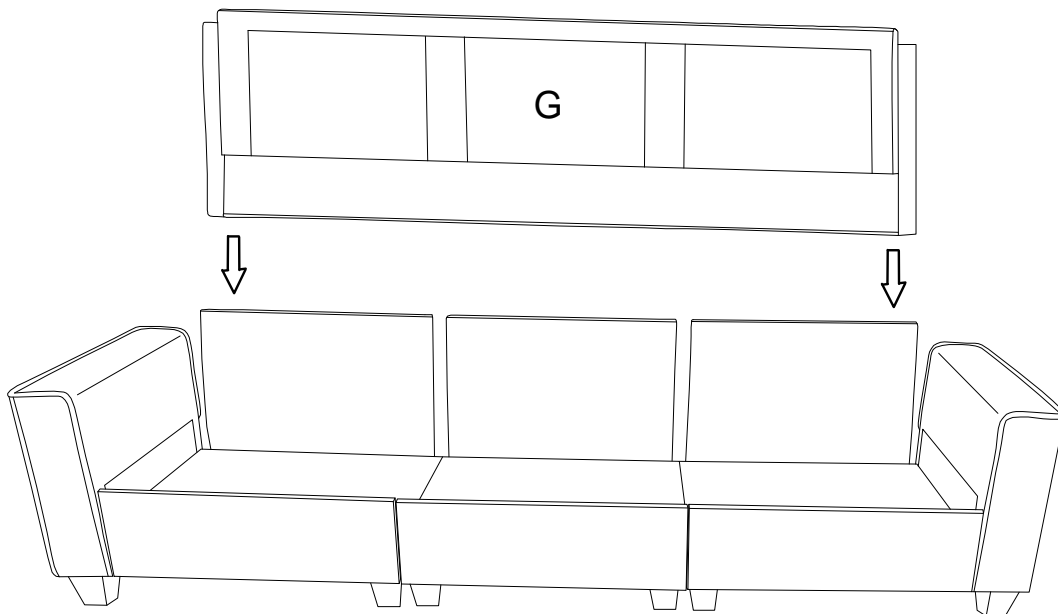



## DIAGRAM 7 (Removal of compression bags)

Remove the Seat cushions (Part C), Back cushions (Part H), Ottomancushion (Part K) and Pillows (Part I).

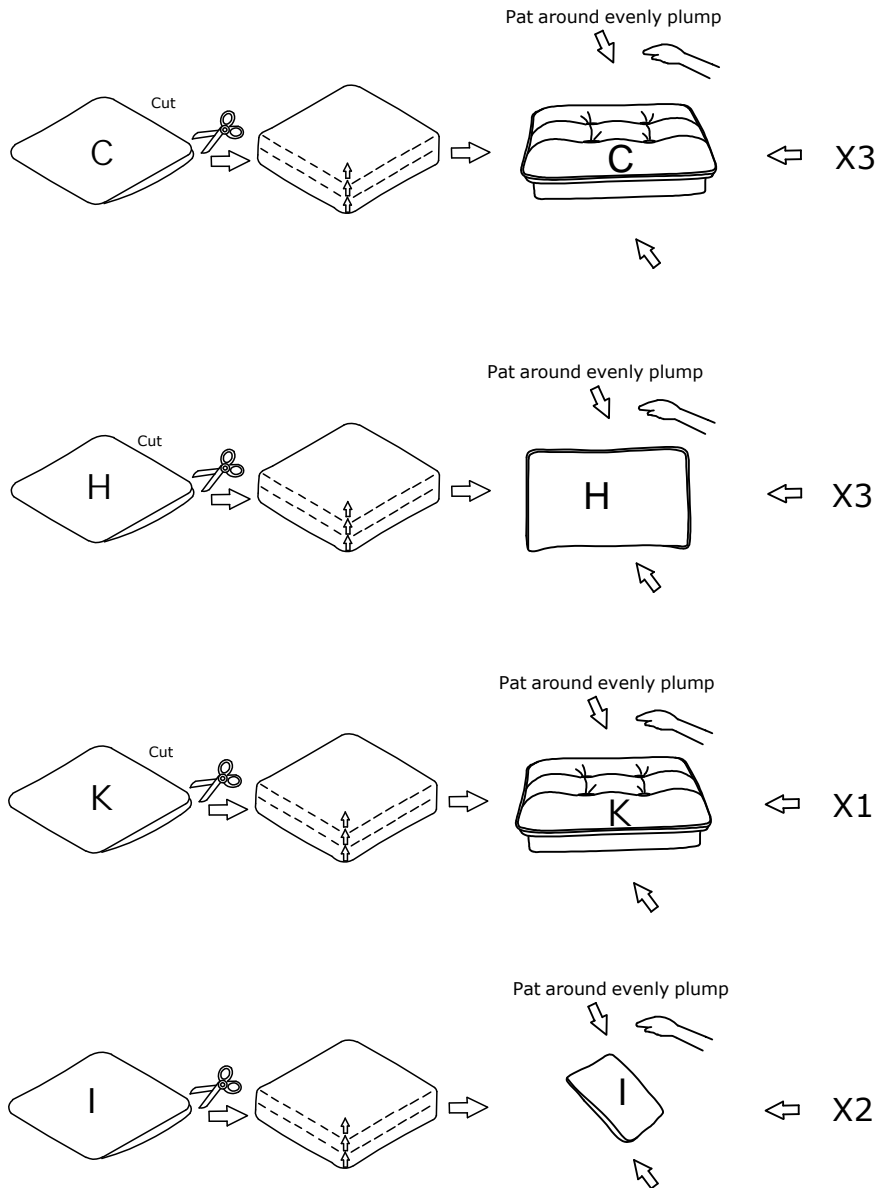

### TIPS

1. Please do not open the compressed packages until your sofa frame is completely assembled.
2. Compressed back cushions and pillows need to be fully fulfilled within 72 hours for your perfect use.
3. Please keep children away from plastic bags or any small pieces of stuff.

**DIAGRAM 8** ( Place the Cushion on the sofa)

Place the Seat cushions (Part C) and Back cushions (Part H) and Pillows (Part I) on the sofa.

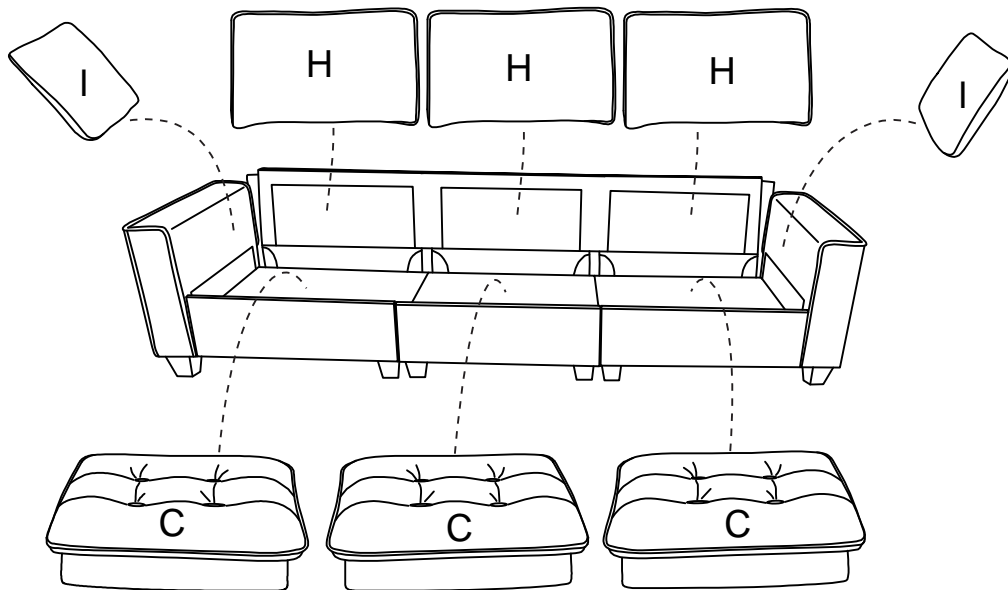

**DIAGRAM 9** ( Place the Cushion on the Ottoman)

Place the Ottoman cushion (Part K) on the Ottoman frame.

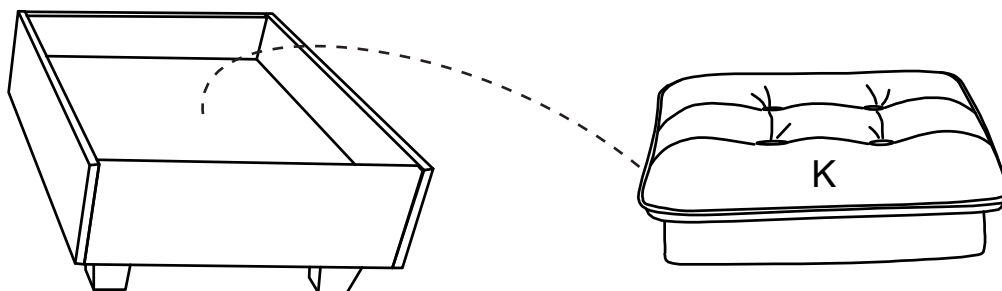

# COMPLETE

